



# PME 38 / PME-NA 36

## Proceedings

Vancouver, Canada | July 15-20, 2014

---

Of the 38th Conference of the International Group for the Psychology of  
Mathematics Education and the 36th Conference of the North American  
Chapter of the Psychology of Mathematics Education

---

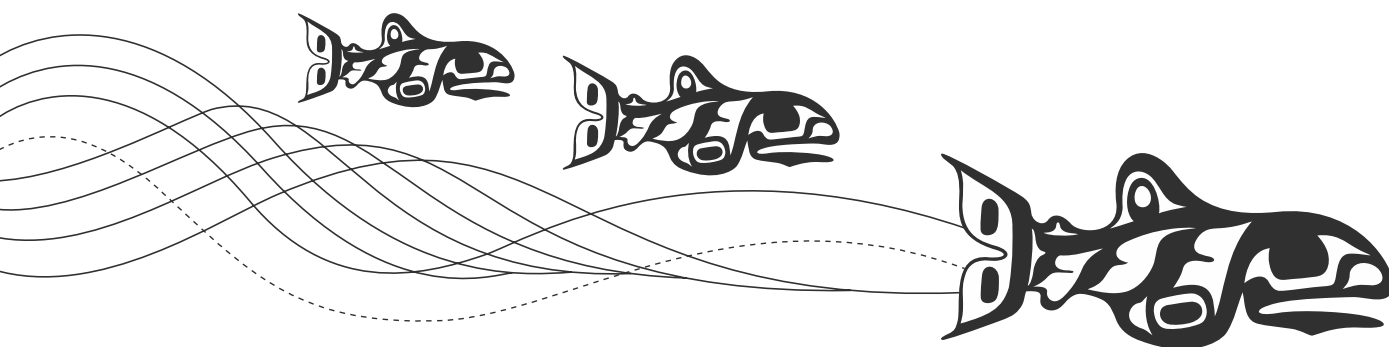

**Volume 3**

---

**Editors** | Susan Oesterle, Peter Liljedahl, Cynthia Nicol, Darien Allan

---

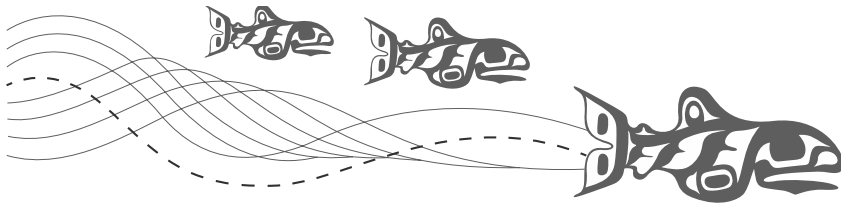

## **PME 38 / PME-NA 36**

**Vancouver, Canada | July 15-20, 2014**

---

Cite as:

Oesterle, S., Liljedahl, P., Nicol, C., & Allan, D. (Eds.). (2014). Proceedings of the 38<sup>th</sup> Conference of the International Group for the Psychology of Mathematics Education and the 36<sup>th</sup> Conference of the North American Chapter of the Psychology of Mathematics Education (Vol. 3). Vancouver, Canada: PME.

or

Oesterle, S., Liljedahl, P., Nicol, C., & Allan, D. (Eds.). (2014). Proceedings of the Joint Meeting of PME 38 and PME-NA 36 (Vol. 3). Vancouver, Canada: PME.

Website: <http://www.pme38.com/>

The proceedings are also available via <http://www.igpme.org>

Copyrights © 2014 left to the authors

All rights reserved

ISSN 0771-100X

Vol. 3 ISBN 978-0-86491-363-0

Set ISBN: 978-0-86491-360-9

Cover Design: Kirsty Robbins, University of British Columbia

Salmon Design: Haida artist, William (Billy) NC Yovanovich Jr. Ts'aahl

Formatting Assistance: Robert Browne, Jacky McGuire

Production: Lebonfon, Québec

# TABLE OF CONTENTS

## VOLUME 3

### RESEARCH REPORTS

#### EL – KNI

THE CASE FOR LEARNING TRAJECTORIES RESEARCH.....	1
<b>Amy B. Ellis, Eric Weber, Elise Lockwood</b>	
PREPARING FUTURE PROFESSORS: HIGHLIGHTING THE IMPORTANCE OF GRADUATE STUDENT PROFESSIONAL DEVELOPMENT PROGRAMS IN CALCULUS INSTRUCTION.....	9
<b>Jessica Ellis</b>	
MATHEMATICAL PRACTICES AS UNDER-DETERMINED LEARNING GOALS: THE CASE OF EXPLAINING DIAGRAMS IN DIFFERENT CLASSROOM MICROCULTURES .....	17
<b>Kirstin Erath, Susanne Prediger</b>	
ON THE STRUCTURE OF SECONDARY HIGH-SCHOOL TEACHERS' BELIEF SYSTEMS ON CALCULUS.....	25
<b>Ralf Erens, Andreas Eichler</b>	
DO SUBJECT SPECIALISTS PRODUCE MORE USEFUL FEEDBACK THAN NON-SPECIALISTS WHEN OBSERVING MATHEMATICS LESSONS?.....	33
<b>Sheila Evans, Ian Jones, Clare Dawson</b>	
EXPLORING MATHEMATICS TOGETHER: FIGURING THE WORLDS OF TEACHERS AND PROSPECTIVE TEACHERS.....	41
<b>Bryan Fede, Marta Civil, Rocío Toscano</b>	
ALGEBRAIC EXPRESSIONS OF DEAF STUDENTS: CONNECTING VISUO-GESTURAL AND DYNAMIC DIGITAL REPRESENTATIONS.....	49
<b>Solange Hassan Ahmad Ali Fernandes, Lulu Healy</b>	
SEEING IN SPACE IS DIFFICULT: AN APPROACH TO 3D GEOMETRY THROUGH A DGE.....	57
<b>Francesca Ferrara, Maria Flavia Mammana</b>	
MATHEMATICAL ACTIVITIES IN A SOCIAL LEARNING FRAMEWORK: HOW MULTIMODALITY WORKS IN A COMMUNITY OF PRACTICE.....	65
<b>Francesca Ferrara, Oi-Lam Ng</b>	

THE TEACHING ACTIVITY AND THE GENERATION OF MATHEMATICAL LEARNING OPPORTUNITIES .....	73
<b>Miquel Ferrer, Josep M. Fortuny, Laura Morera, Núria Planas</b>	
CONNECTING A MATHEMATICS TEACHER’S CONCEPTIONS AND SPECIALISED KNOWLEDGE THROUGH HER PRACTICE .....	81
<b>Eric Flores, José Carrillo</b>	
ONLINE MATHEMATICS TEACHER EDUCATION: MAIN TOPICS, THEORETICAL APPROACHES, TECHNIQUES AND CHANGES IN RESEARCHERS' WORK .....	89
<b>Eric Flores, Dinazar I. Escudero, Mario Sánchez Aguilar</b>	
MATHEMATICAL KNOWLEDGE FOR TEACHING PROBLEM SOLVING: LESSONS FROM LESSON STUDY .....	97
<b>Colin Foster, Geoff Wake, Malcolm Swan</b>	
JAMILA’S STORY: ANALYSING AFFECTIVE BEHAVIORS THROUGH A PRAGMATIST PERSPECTIVE OF IDENTITY .....	105
<b>Cristina Frade, Stephen Lerman, Luciano Meira</b>	
WHAT DID THE STUDENTS LEARN FROM MATHEMATICS TEXTBOOKS? THE CASE OF L. F. MAGNITSKII’S <i>ARITHMETIC</i> .....	113
<b>Viktor Freiman, Alexei Volkov</b>	
BLACK AND WHITE MARBLES – OLDER PRIMARY STUDENTS’ INTUITIVE CONCEPTIONS AND APPROACHES CONCERNING RATIOS .....	121
<b>Torsten Fritzlar, Roland Rink</b>	
WHY LECTURES IN ADVANCED MATHEMATICS OFTEN FAIL .....	129
<b>Tim Fukawa-Connelly, Kristen Lew, Pablo Mejia-Ramos, Keith Weber</b>	
CULTURE AND DISADVANTAGE IN LEARNING MATHEMATICS .....	137
<b>Peter Gates, Shafia Abdul Rahman</b>	
MAKING SENSE OF THE MULTIPLE MEANINGS OF ‘EMBODIED MATHEMATICS LEARNING’ .....	145
<b>Susan Gerofsky</b>	
USING ICT IN TEACHING A SPECIFIC MATHEMATICS CONCEPT: GRAPHS OF LOGARITHMIC FUNCTIONS .....	153
<b>Seyum Tekeher Getenet, Kim Beswick</b>	
REVEALING STUDENTS' CREATIVE MATHEMATICAL ABILITIES THROUGH MODEL-ELICITING ACTIVITIES OF “REAL-LIFE” SITUATIONS .....	161
<b>Talya Gilat, Miriam Amit</b>	

VALIDATING IN THE MATHEMATICS CLASSROOM .....	169
<b>Manuel Goizueta, Maria Alessandra Mariotti, Núria Planas</b>	
“I ALSO WANT THEM TO FEEL COMFORTABLE”: AFFECT AND THE FORMATION OF PROFESSIONAL IDENTITY .....	177
<b>Carlos Nicolas Gomez, AnnaMarie Conner</b>	
EXPLORING FRACTION COMPARISON IN SCHOOL CHILDREN .....	185
<b>David M. Gómez, Abelino Jiménez, Roberto Bobadilla, Cristián Reyes, Pablo Dartnell</b>	
PERSONAL BELIEFS AND GENDER GAPS IN MATHEMATICS.....	193
<b>Inés M<sup>a</sup> Gómez-Chacón, Gilah Leder, Helen Forgasz</b>	
PRE-UNIVERSITY STUDENTS’ PERSONAL RELATIONSHIP WITH THE VISUALISATION OF SERIES OF REAL NUMBERS.....	201
<b>Alejandro S. González-Martín</b>	
THE INFLUENCE OF GRAPHICS IN MATHEMATICS TEST ITEM DESIGN .....	209
<b>Jane Greenlees, Tracy Logan</b>	
INVESTIGATING STUDENTS' GEOMETRICAL PROOFS THROUGH THE LENS OF STUDENTS' DEFINITIONS.....	217
<b>Aehsan Haj Yahya, Rina Hershkowitz, Tommy Dreyfus</b>	
GENDER-NEUTRAL, YET GENDERED: EXPLORING THE CANADIAN GENERAL PUBLIC’S VIEWS OF MATHEMATICS.....	225
<b>Jennifer Hall</b>	
WHAT AND HOW MATHEMATICS SHOULD BE TAUGHT: VIEWS OF SECONDARY MATHEMATICS TEACHER CANDIDATES WITH STEM BACKGROUNDS.....	233
<b>Allyson Hallman-Thrasher, Jeff Connor</b>	
TEACHING LINEAR ALGEBRA IN THE EMBODIED, SYMBOLIC AND FORMAL WORLDS OF MATHEMATICAL THINKING: IS THERE A PREFERRED ORDER? .....	241
<b>John Hannah, Sepideh Stewart, Mike Thomas</b>	
A LONGITUDINAL ANALYSIS OF THE RELATIONSHIP BETWEEN MATHEMATICS-RELATED AFFECT AND ACHIEVEMENT IN FINLAND .....	249
<b>Markku S. Hannula, Emmanuel Bofah, Laura Tuohilampi, Jari Metsämuuronen</b>	
A THEORETICAL FRAMEWORK FOR THE FUNCTION OF GENERALIZATION IN LEARNING MATHEMATICS .....	257
<b>Toru Hayata, Masataka Koyama</b>	

HOW SHOULD STUDENTS REFLECT UPON THEIR OWN ERRORS WITH RESPECT TO FRACTION PROBLEMS? .....	265
<b>Tim Heemsoth, Aiso Heinze</b>	
MATHEMATICS TEACHERS' RECOGNITION OF AN OBLIGATION TO THE DISCIPLINE AND ITS ROLE IN THE JUSTIFICATION OF INSTRUCTIONAL ACTIONS .....	273
<b>Patricio Herbst, Justin Dimmel, Ander Erickson, Inah Ko, Karl W. Kosko</b>	
FROM KNOWLEDGE AGENTS TO KNOWLEDGE AGENCY .....	281
<b>Rina Hershkowitz, Michal Tabach, Chris Rasmussen, Tommy Dreyfus</b>	
THE SPACE BETWEEN THE UNKNOWN AND A VARIABLE.....	289
<b>Dave Hewitt</b>	
STUDENTS' UNDERSTANDING OF SQUARE NUMBERS AND SQUARE ROOTS .....	297
<b>Erica J. A. Hiebert</b>	
INTERACTIVE CONSTRUCTION OF ATTENTION PATHS TOWARD NEW MATHEMATICAL CONTENT: ANALYSIS OF A PRIMARY MATHEMATICS LESSON ....	305
<b>Keiko Hino, Yuka Koizumi</b>	
VISUAL AND ANALYTICAL STRATEGIES IN SPATIAL VISUALIZATION: PERSPECTIVES FROM BILATERAL SYMMETRY AND REFLECTION .....	313
<b>Siew Yin Ho, Ajay Ramful, Tom Lowrie</b>	
RELATING STUDENT OUTCOMES TO TEACHER DEVELOPMENT OF STUDENT-ADAPTIVE PEDAGOGY .....	321
<b>Nicola Hodkowski, Ron Tzur, Heather Lynn Johnson, Evan McClintock</b>	
HOW IS THE FUNCTION CONCEPT INTRODUCED IN TEXTBOOKS?: A COMPARATIVE ANALYSIS .....	329
<b>Dae S. Hong, Kyong Mi Choi</b>	
THE IMPORTANCE OF ACHIEVING PROFICIENCY WITH SIMPLE ADDITION .....	337
<b>Sarah Hopkins, Donna Bayliss</b>	
WHAT ASPECTS OF MATHEMATICAL LITERACY SHOULD TEACHERS FOCUS ON FROM THE STUDENT'S POINT OF VIEW?.....	345
<b>Feng-Jui Hsieh, Ting-Ying Wang</b>	
INVESTIGATING CHILDREN'S ABILITY TO SOLVE MEASUREMENT ESTIMATION PROBLEMS.....	353
<b>Hsin-Mei E. Huang</b>	

SMALL GROUP INTERACTIONS: OPPORTUNITIES FOR MATHEMATICAL LEARNING .....	361
<b>Roberta Hunter, Glenda Anthony</b>	
U.S. POLITICAL DISCOURSE ON MATH ACHIEVEMENT GAPS IN LIGHT OF FOUCAULT'S GOVERNMENTALITY .....	369
<b>Salvatore Enrico Indiochine, Gerald Kulm</b>	
RELATING STUDENT MEANING-MAKING IN MATHEMATICS TO THE AIMS FOR AND DESIGN OF TEACHING IN SMALL GROUP TUTORIALS AT UNIVERSITY LEVEL .....	377
<b>Barbara Jaworski, M. Gözde Didis</b>	
A CASE STUDY OF CONFLICTING REALIZATIONS OF CONTINUITY .....	385
<b>Gaya N. Jayakody</b>	
AN ANALYSIS OF MATHEMATICAL PROBLEM-POSING TASKS IN CHINESE AND US REFORM TEXTBOOKS .....	393
<b>Chunlian Jiang, Jinfa Cai</b>	
THE FREQUENCIES OF VARIOUS INTERPRETATIONS OF THE DEFINITE INTEGRAL IN A GENERAL STUDENT POPULATION.....	401
<b>Steven R. Jones</b>	
YOUNG CHILDREN'S THINKING ABOUT VARIOUS TYPES OF TRIANGLES IN A DYNAMIC GEOMETRY ENVIRONMENT .....	409
<b>Harpreet Kaur, Nathalie Sinclair</b>	
IMPROVING STUDENT LEARNING IN MATH THROUGH WEB-BASED HOMEWORK .....	417
<b>Kim Kelly, Neil Heffernan, Cristina Heffernan, Susan Goldman, James Pellegrino, Deena Soffer-Goldstein</b>	
THE QUALITY OF ARGUMENTATIONS OF FIRST-YEAR PRE-SERVICE TEACHERS ....	425
<b>Leander Kempen, Rolf Biehler</b>	
VIDEO-BASED MEASUREMENT OF PRIMARY MATHEMATICS TEACHERS' ACTION-RELATED COMPETENCES .....	433
<b>Imke Knievel, Anke Lindmeier, Aiso Heinze</b>	
INDEX OF AUTHORS AND COAUTHORS VOLUME 3 .....	443





**RESEARCH REPORTS**

**EL – KNI**

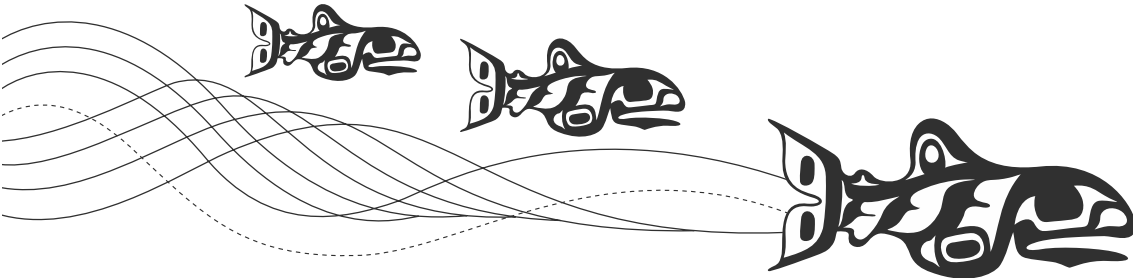



# THE CASE FOR LEARNING TRAJECTORIES RESEARCH

Amy B. Ellis<sup>1</sup>, Eric Weber<sup>2</sup>, Elise Lockwood<sup>2</sup>

<sup>1</sup>University of Wisconsin-Madison, <sup>2</sup>Oregon State University

*This paper addresses the role of learning progressions in informing many international standards documents, discussing the affordances and limitations of building standards and curricula from a learning progression model. An alternate model, the hypothetical learning trajectory, is introduced and contrasted with learning progressions. Using the example of exponential functions, learning progressions are compared to learning trajectories in terms of their theoretical origins and practical implications. Recommendations for further work building learning trajectories in secondary mathematics are discussed.*

## INTRODUCTION

Curriculum development increasingly relies on guidance from national content standards or benchmarks, with standards-based accountability growing as a movement internationally (e.g., Australian Ministerial Council on Education, Employment, Training and Youth Affairs, 2006; Ministry of Education of the People's Republic of China, 2003; National Governor's Association Center for Best Practices, 2010; UK Department of Education, 2009). Given the proliferation of content standards and their influence on curriculum development, the quality of such standards and their adherence to research on students' learning is a key concern. However, evidence suggests that mathematics content standards typically approach learning goals from the perspective of sophisticated mathematical expertise, failing to address students' conceptual development (Olive & Lobato, 2008). Lobato et al. (2012) conducted a survey of the mathematics content standards for seven countries focusing on quadratic functions and found that nearly all of the standards emphasized procedural knowledge and lacked specificity addressing conceptual knowledge.

This paper discusses a typical approach guiding the development of many standards documents, that of a learning progression, and considers some of the limitations of learning progressions for informing standards and curricula. Using the example of exponential functions, we contrast the theoretical underpinnings of learning progressions with an alternate construct, the learning trajectory, and argue for the merits of learning trajectory research for developing content standards.

## BACKGROUND AND THEORETICAL FRAMEWORK: LEARNING PROGRESSIONS AND LEARNING TRAJECTORIES

A learning progression is a sequence of successively more complex ways of reasoning about a set of ideas (National Assessment Governing Board, 2008). This definition situates a learning progression as a tool for curriculum design; the progression is a

construct for organizing mathematical content in order to provide a potential path through which students can traverse as they develop competence in the domain. Recent years have seen an increased focus on the development and elaboration of learning progressions, and in the use of learning progressions to inform standards documents. For instance, the American Institute for Research (2009) released a report calling for the development of standards based on learning progressions gleaned from analysing the content standards of three high-performing countries, Hong Kong, Korea, and Singapore. This study produced a set of composite standards guided by “learning progressions of specific competencies within each topic across grades” (p. 2). Similarly, Fuhrman, Resnick, and Shepard (2009) made the case for incorporating learning progressions into content standards documents by referencing high-performing countries such as Singapore, Japan, South Korea, and the Czech Republic, emphasizing the importance of building curricula “based on sequences, or progressions, of increasingly sophisticated concepts and knowledge applications” (p. 28). A learning progression characterizes movement from novice to expert through the acquisition of relevant facts, skills, and concepts (National Assessment Governing Board, 2008).

Learning progressions have at times been treated as interchangeable with learning trajectories, but the two constructs have significantly different theoretical origins (Empson, 2011). The notion of a hypothetical learning trajectory has different meanings among mathematics education researchers. Simon’s (1995) original discussion offered a description of a hypothetical learning trajectory consisting of “the learning goal, the learning activities, and the thinking and learning in which students might engage” (p. 133). Clements and Sarama (2004) expand on this definition, describing a learning trajectory as an elaboration of children’s thinking and learning in a specific mathematical domain, connected to a conjectured route through a set of tasks designed to support movement through a progression of levels of thinking. These definitions emphasize the construct as a teacher-researcher’s model, a tool for hypothesizing what students might understand about a particular mathematical topic and how students’ understanding may change over time in interaction with carefully-designed tasks and teaching actions.

A learning trajectory is an account of changes in a student’s schemes and operations; as such, it is a tool that seeks to explain learning that occurs over time, specifying the particular schemes and operations in play and elaborating how accommodation occurs to build up knowledge. This view of a learning trajectory differs significantly from learning progression frameworks emphasizing strategies or skills.

### **Challenges with Basing Standards Documents on Learning Progressions**

Learning progressions are based on the researcher’s knowledge of the field of mathematics. Steffe and Olive (2010) describe this as first-order knowledge, “the models an individual constructs to organize, comprehend, and control his or her experience, i.e., their own mathematical knowledge” (p. 16). Much of the organization of international content standards is based on first-order knowledge. Critiques of the

learning progression approach to standards documents emphasize, however, that the development of a progression cannot be based on an analysis of the discipline alone. In particular, content learning cannot be separated from activity and context; what students learn is intricately connected to the types of instructional tasks they encounter, the manner in which teachers foster students' thinking with those tasks, and the ways in which students interact with one another and with their teachers (Empson, 2011). Mathematical learning occurs in interaction, with teachers' actions profoundly influencing student thinking. One of the most difficult issues facing researchers constructing learning progressions, then, is the need to attend more explicitly to the role played by teaching interactions and to determine how instructional variation affects these progressions (Simon et al., 2010).

These concerns are borne out by the meticulous research base demonstrating the non-convergence of children's learning in some areas of mathematics, such as number, fractions, and ratio and proportion (e.g., Steffe & Olive, 2010). In addition, standards based on learning progressions may fail to account for how different students approach the same mathematical idea from different conceptual bases. A more efficacious approach may be one that attends to the variation in students' conceptual development, building trajectories of student understanding over time.

## **LEARNING TRAJECTORIES AS AN ALTERNATE MODEL**

While learning progressions are typically based on first-order knowledge, learning trajectories are an elaboration of researchers' second-order mathematical knowledge, "the models observers may construct of the observed person's knowledge" (Steffe & Olive, 2010, p. 16). As such learning trajectories are concerned with identifying the mathematics of students, elaborating models of students' mathematical concepts and operations. Lobato et al. (2012) noted that an analysis of students' constructions can also inform the way researchers conceive of the mathematics itself; a construction of second-order models can inform our first-order knowledge of the domain.

A learning progression typically presents a target construct or skill, an associated learning goal, evidence for achievement of the learning goal, and tasks designed to foster that achievement. Table 1 contrasts the ways in which learning progressions and learning trajectories address each of these four categories in general. Using the specific example of exponential functions, we then compiled typical statements of mathematical constructs, learning goals, and evidence from international standards documents that included exponential functions, particularly Chinese Taipei (Ministry of Education of Taiwan, 2003), China (Ministry of Education of the People's Republic of China, 2003), and the United States (National Governor's Association Center for Best Practices, 2010) (see Table 2). Table 2 contrasts a learning progression approach with a learning trajectory approach for one sample construct/concept about exponential functions; due to space constraints, one example rather than an entire progression and trajectory is provided.

Learning Progression		Learning Trajectory	
Construct	<ul style="list-style-type: none"> <li>• Based on 1<sup>st</sup>-order knowledge</li> <li>• Define levels in terms of subject-matter competencies</li> <li>• Constructs elaborated as formal mathematics</li> </ul>	Concept	<ul style="list-style-type: none"> <li>• Based on 2<sup>nd</sup>-order knowledge</li> <li>• Define stages of student thinking</li> <li>• Concepts elaborated in terms of students' mental activity</li> </ul>
Learning Goals	<ul style="list-style-type: none"> <li>• Description of skills and procedures</li> <li>• Specifies target performances</li> </ul>	Characterization	<ul style="list-style-type: none"> <li>• Description of the nature of student's thinking</li> <li>• Identifies relevant schemes</li> </ul>
Evidence	<ul style="list-style-type: none"> <li>• Describes the necessary performance; focus on external performance</li> <li>• Identifies external strategies</li> <li>• Based on mathematical domain</li> </ul>	Examples	<ul style="list-style-type: none"> <li>• Describes conceptions based on strategies, language, activity</li> <li>• Identifies mental activity</li> <li>• Based on evidence of student activity</li> </ul>
Tasks	<ul style="list-style-type: none"> <li>• Developed from content analysis</li> <li>• Goal is to elicit target performances</li> <li>• Provided as stand-alone problems</li> </ul>	Activities	<ul style="list-style-type: none"> <li>• Developed from retrospective analysis of teaching experiments</li> <li>• Goal is to support emerging concept development</li> <li>• Provided with context and pedagogical connections</li> </ul>

Table 1: Learning progressions contrasted with learning trajectories

### Construct versus Concept

Constructs arise from adults' first-order knowledge of mathematics, and thus are developed according to the logic of the discipline. It is typical for constructs to describe formal mathematical ideas, strategies, or procedures. For instance, consider the case of exponential functions. A learning progression might describe a construct for exponential functions in terms of the desired subject matter competency without regard to the qualitative difference in thinking at different stages. The construct describes the mathematical idea, for instance, "Express a situation in which a quantity grows by a constant per-cent rate as  $y = ab^x$ ." Rather than specifying a mental operation, the construct specifies a particular algebraic representation, as conceived by the researcher. This type of progression is concerned with identifying instructional goals framed in terms of target performances rather than target concepts.

We can contrast this approach with a learning trajectory approach, drawing on a learning trajectory describing middle-school students' initial understanding of exponential growth (see Ellis et al., 2013). A learning trajectory will define a concept in terms of student understanding, and would base concept definitions on existing knowledge of students' ways of operating. For instance, one conceptual stage students achieve when developing ideas of exponential growth is that they can coordinate multiplicative change in  $y$  with additive change in  $x$ . A concept at this stage would include the understanding "that the ratio of  $y_2$  to  $y_1$  for a corresponding change in  $x$  holds for any  $\Delta x$  value, even when  $\Delta x$  is  $< 1$ ."

Learning Progression		Learning Trajectory	
Construct	Express situations in which a quantity grows by a constant per-cent rate per unit interval relative to another as $y = ab^x$ where $b$ is a whole number and $x$ is non-negative.	Concept	Coordinate change in $y$ for any-value change in $x$ : Understand that the ratio of $y_2$ to $y_1$ for a corresponding change in $x$ holds for any $\Delta x$ value, even when $\Delta x$ is $< 1$ .
Learning Goals	<ul style="list-style-type: none"> <li>Understand the meanings of the power in an exponential expression</li> <li>Comprehend the calculations involving base numbers as whole numbers and exponents as non negatives</li> <li>Interpret the parameters <math>a</math> and <math>b</math> in terms of a context</li> </ul>	Characterization	<ul style="list-style-type: none"> <li>One can coordinate the ratio of any two <math>y</math>-values for any-time gaps in corresponding <math>x</math> values.</li> <li>Imagery is reliant on constant ratios, and is no longer grounded in images of repeated multiplication.</li> <li>Understanding that the expression <math>b^x</math> can represent both a static height value and a measure of growth for two values <math>x</math> time units apart.</li> </ul>
Evidence	<ul style="list-style-type: none"> <li>Use repeated multiplication to find missing table values</li> <li>Write correct equations in the form <math>y = b^x</math> and <math>y = ab^x</math></li> <li>Perform correct calculations such as <math>3^2 \times 3^4 = 3^6</math></li> <li>Recognize a non-zero <math>a</math>-value as the functions' initial value</li> </ul>	Examples	<p>d) How much bigger would the plant get in 1 day?</p> <p><math>1 \div 7 = .14</math>, <math>3^{14} = 1.17</math></p> <p>its, <math>1 \div 7</math> because it only shows the result for 1 week on the table &amp; there are 7 day in a week, so I divided 1 week into 7 parts which represent 1 day each and it .14 of a week</p>
Tasks	<ul style="list-style-type: none"> <li>Missing-value tables and far-prediction problems</li> <li>Cell growth, population growth, and compound interest modelling problems</li> </ul>	Activities	<ul style="list-style-type: none"> <li>First provide tasks with only two data points with large-time gaps in which students must determine the growth factor. Large gaps will encourage shifts away from repeated multiplication.</li> <li>Next, provide tasks in which students must determine amounts of growth for a half-unit or other fractional amount of time.</li> </ul>

Table 2: Contrasting a progression with a trajectory for exponential functions

Imagine two students who are at two different stages in their developing understanding of exponential growth. The first student can coordinate the ratio of two  $y$ -values for corresponding  $x$ -values when  $\Delta x \geq 1$ , but his mental imagery is grounded in repeated multiplication. For instance, this student may compare the height of an exponentially-growing plant at two different time points: After 2 weeks, the plant is 4 inches tall, and after 5 weeks, the plant is 32 inches tall. This student can conceive of the plant at 5 weeks as 8 times as tall is it was at 2 weeks by taking the 4 inches at 2 weeks and doubling it three times: 8 inches, 16 inches, 32 inches. This student may even be able to express this idea as  $2^3$ , but that expression is grounded in a mental operation of doubling the height three times. This student's ability to imagine a process

of repeated multiplication has some limitations; because he must mentally go through the process of doubling in order to compare two values, he cannot extend that process for very large-week gaps, or make sense of gaps smaller than 1.

Imagine a second student whose imagery is no longer grounded in a process of repeated multiplication. This student has mentally truncated the process to the point at which she can think about multiplicatively comparing two heights for large-week gaps and does not have to go through the operation of doubling for each and every week between  $x_1$  and  $x_2$ . This student can express the ratio  $R$  of two height values as  $b^x = R$  for the growth factor  $b$ . This expression no longer represents a process of multiplying by the growth factor  $b$   $x$  times, but instead is grounded in an image of a constant ratio change in  $y$  for any constant additive change in  $x$ . This student may use language and gestures to indicate a notion of continuous scaling or magnification, and her imagery enables her to make sense of growth even when  $\Delta x$  is not a whole number. In both cases, the students may write the same algebraic expression  $b^x$ , but the expression is a result of different ways of operating and means different things to the two students. A learning trajectory should account for these differences in students' thinking and aim to capture them in its description of conceptual stages.

### **Learning Goals versus Concept Characterization**

In order to develop a learning progression one might engage in task analysis (Gagné, 1977) to identify the capabilities one must possess in order to perform a specific mathematical task. For exponential functions this may include using repeated multiplication to determine missing table values, writing correct equations and performing correct calculations with exponents, and identifying the parameter “ $a$ ” as the initial value of a function when  $x = 0$ . Note that these learning goals are framed in terms of target performances.

In contrast, learning trajectories are built on empirical evidence from working with students. The exponential functions learning trajectory emerged from repeated cycles of retrospective analysis of two teaching experiments with groups of middle-school students (see Ellis et al., 2013). Each teaching experiment lasted approximately 15 1-hour sessions and was videotaped and transcribed. Rather than describing target performances, the learning trajectory characterizes the nature of students' thinking at a particular stage, for instance, by specifying that a students' imagery is grounded in constant ratios rather than repeated multiplication. One aim of these characterizations is to explain how students' ways of thinking, schemes, and operations provide an explanation for how they solve problems.

### **Evidence versus Examples**

Learning progressions focus on elaborating the necessary strategies, performances, and other observable behaviour for determining whether a student has met the learning goals. Evidence of this nature does not address how students' conceptions will change as they progress from one level to the next. Rather than providing an account of learning that makes performance possible, the emphasis is on the performance itself,



which is taken as evidence of learning. While much can be gained from a careful analysis of students' strategies, a focus on strategies to the exclusion of mental activity leaves much unknown about how learning progresses over time. In contrast, a learning trajectory builds evidence from students' actions in teaching-experiment settings. Ongoing and retrospective analysis informs the construction of models of students' thinking. Here the example evidence from Table 2 is from a task in which students had to predict, for a plant that tripled in height each week, how much larger it would grow in 1 day. One student wrote the expression " $3^{14} = 1.17$ ", explaining, "I divided 1 week into 7 parts, which represents 1 day each and it's .14 of a week." This is evidence that the student could make sense of a non-integer exponent and could conceive of the expression  $3^{14}$  as a measure of growth, an important feature of coordinating the ratio of  $y$ -values for time gaps smaller than 1 week.

### Tasks versus Activities

Tasks for learning progressions, like activities for learning trajectories, may come from empirical evidence with large or small groups of students. Such tasks may also be developed, however, from a curricular analysis or other investigations focusing more on the content domain than on students' thinking. One advantage of the learning trajectory approach is its empirical origins; descriptions of students' conceptions evolve in relationship to their interactions with activities. Thus a learning trajectory could provide a way to include instructional moves or other contextual suggestions along with related activities. In Table 2, the two sample problem types are briefly provided with explanations about their ordering and justification.

### DISCUSSION

Building learning trajectories requires a great deal of work in identifying a precise set of schemes and operations to serve as a model for informing how a student might be operating at a particular stage. Some of this work has already been done, particularly in the work of early number, fractions, and measurement (e.g., Clements & Sarama, 2004; Steffe & Olive, 2010), but few models of this type exist for algebra and beyond. While there are promising steps in this direction, much work remains to develop tools to a) characterize qualitative distinctions in students' thinking at different stages of development, and b) identify mechanisms of learning driving students' transitions from one stage to the next (Simon et al., 2010). A stronger emphasis on learning trajectories research moving forward could support the development of standards and topic sequences that account for research-based findings on students' conceptual development over time, thus leading to more useful guides for teachers at all grade levels.

### References

American Institutes for Research. (2009). *Informing grades 1-6 mathematics standards development: What can be learned from high-performing Hong Kong, Korea, and Singapore?* Washington, DC: Author.

- Australian Ministerial Council on Education, Employment, Training and Youth Affairs (2006). *Statements of learning for mathematics*. Carlton South Vic, AU: Curriculum Corporation.
- Clements, D., & Sarama, J. (2004). Learning trajectories in mathematics education. *Mathematical Thinking and Learning*, 6(2), 81-89.
- Ellis, A. B., Ozgur, Z., Kulow, T., Williams, C. C., & Amidon, J. (2013). An exponential growth learning trajectory. In A. M. Lindmeier & A. Heinze (Eds.), *Proc. 37<sup>th</sup> Conf. of the Int. Group for the Psychology of Mathematics Education* (Vol. 2, pp. 273-280). Kiel, Germany: PME.
- Empson, S. (2011). On the idea of learning trajectories: Promises and pitfalls. *The Mathematics Enthusiast*, 8(3), 571-596.
- Fuhrman, S., Resnick, L., & Shepard, L. (2009). Commentary: Standards aren't enough. *Education Week*, 29(7), 28.
- Gagné, R.M. (1977). *The conditions of learning*. New York: Holt, Rinehard, & Wintson.
- Lobato, J., Hohensee, C., Rhodehamel, D., & Diamond, J. (2012). Using student reasoning to inform the development of conceptual learning goals: The case of quadratic functions. *Mathematical Thinking and Learning*, 14, 85-119.
- Ministry of Education of the People's Republic of China. (2003). *Ordinary senior secondary mathematics curriculum standards (experimental version)*. Beijing, China: People's Educational Press.
- Ministry of Education of Taiwan (ME). (2003). *Curriculum guidelines for the elective subject math (ii) in senior high school*. Retrieved from <http://www.apecknowledgebank.org>
- National Assessment Governing Board. (2008). *NAEP 2009 science framework (ED-04-CO-0148)*. Washington, DC: Author.
- National Governors Association Center for Best Practices, Council of Chief State School Officers. (2010). *Common core state standards on mathematics*. Washington, DC: Authors.
- Olive, J., & Lobato, J. (2008). The learning of rational number concepts using technology. In M. K. Heid, & G. W. Blume (Eds.), *Research on technology and the teaching and learning of mathematics: Research syntheses* (pp. 1-54). Charlotte, NC: Information Age and the National Council of Teachers of Mathematics.
- Simon, M. (1995). Reconstructing mathematics pedagogy from a constructivist perspective. *Journal for Research in Mathematics Education*, 26(2), 347-395.
- Simon, M. A., Saldanha, L., McClintock, E., Karagoz Akar, G., Watanabe, T., & Ozgur Zembat, I. (2010). A developing approach to studying students' learning through their mathematical activity. *Cognition and Instruction*, 28, 70-112.
- Steffe, L. P., & Olive, J. (2010). *Children's fractional knowledge*. New York: Springer.
- UK Department for Education. (2009). *The national strategies: The framework for secondary mathematics*. London, UK: Crown.

# **PREPARING FUTURE PROFESSORS: HIGHLIGHTING THE IMPORTANCE OF GRADUATE STUDENT PROFESSIONAL DEVELOPMENT PROGRAMS IN CALCULUS INSTRUCTION**

Jessica Ellis

San Diego State University

*This report details the importance of professional development and training for graduate student teaching assistants (GTAs) in the teaching of calculus. Findings from a large, national study in the United States show that GTAs are teaching a large percentage of Calculus I students (either as the primary teacher or as a recitation leader), receiving widely varied preparation for this teaching, and experiencing this preparation to varying degrees of effectiveness. The results motivate the need to further investigate the current landscape of GTA professional development, and lay the groundwork for subsequent analyses to explore connections between GTA PD, instructor attributes, such as beliefs and practices, and student success.*

## **INTRODUCTION**

In this report I investigate the current state of graduate student teaching assistant (GTA) professional development (PD) programs among math departments employing GTAs in the teaching of Calculus I. In particular I examine (a) the number of Calculus I students being taught by GTAs compared to other instructor types, (b) the ways institutions are employing GTAs in the teaching of Calculus I, and (c) the frequency and effectiveness of various means of preparing and selecting GTAs for their roles in the teaching of Calculus I. Data for this study comes from a large, national study in the United States focused on successful calculus programs conducted under the auspices of the Mathematical Association of America (MAA). Initial reports from the project indicate that a number of student, instructor, and institutional characteristics appear to be associated with more successful programs, and serve as a backdrop to this study on GTAs roles in Calculus I (Bressoud, Carlson, Mesa, & Rasmussen, 2013).

Calculus I is not only an integral part of all Science, Technology, Engineering, and Mathematics (STEM) fields, but it has also been shown as a critical contributing factor in students' decisions to leave the STEM disciplines (Seymour & Hewitt, 1997). Graduate student teaching assistants contribute to calculus instruction in two ways: as the primary teacher and as recitation leaders. As the primary teacher, GTAs are completely in charge of the course, just as a lecturer or tenure-track/ tenured faculty member would be, although GTAs may lack the experience, education, or time commitment of their faculty counterparts.

GTAs can also be viewed as the next generation of mathematics instructors. This means that in addition to their immediate contribution to the landscape of Calculus I instruction, GTAs contribute significantly to the long-term state of undergraduate mathematics instruction. The preparation GTAs receive for teaching calculus therefore influences both their immediate teaching practices as well as their long-term pedagogical behavior. There has been significant interest regarding what knowledge and experiences are needed to foster excellent (or even adequate) teachers of mathematics at the K-12 level (Ball, Thames, & Phelps, 2008; Hill, Ball, & Schilling, 2008; Shulman, 1986) and instructors at the undergraduate level (Johnson & Larsen, 2012; Wagner, Speer, & Rossa, 2007; Zazkis & Zazkis, 2011). From these investigations, it is clear that expertise in mathematics alone is not sufficient in the preparation of teachers.

Professional development efforts to improve teaching at the K-12 level are often aimed at developing teachers' knowledge, beliefs, and instructional practices in order to improve their students' success, and to enculturate new teachers into the teaching community (Putnam & Borko, 2000; Sowder, 2007). Literature surrounding GTA PD is growing, though still little is known about the current climate of GTA professional development on a national level. In this study I examine the roles and preparation of GTAs involved in the teaching of Calculus I across the US.

## **BACKGROUND**

The National Science Board (NSB, 2008) uses the term “professional development” to refer both to teacher preparation (i.e. for preservice teachers) and to the development of practicing teachers (i.e. for in-service teachers). Graduate student teaching assistants (GTAs) have commonalities with both preservice and in-service teachers: the training they receive as GTAs is typically their first instructional training; however, they often receive this training after they have begun teaching.

The literature surrounding GTA professional development is growing as national reports point to the significance of undergraduate education, especially in preparing students in the STEM disciplines (e.g., PCAST, 2012), and as GTAs play an increasingly important role in the teaching of STEM courses (Belnap & Allred, 2009; CBMS, 2005, 2010). Preliminary results from the most recent College Board of Mathematical Sciences (CBMS) survey show that, while there is a steady increase in the number of students enrolled in introductory mathematics courses nationwide, there is a 5 percent decrease in the number of tenured and tenure-track mathematics faculty from 2005 to 2010 (Lutzer et al., 2007). The heightened instructional need is being met by an increase in the number of GTAs, postdoctoral appointments, and adjunct faculty.

Increased attention to GTA training is necessitated by the growing employment of GTAs in the teaching of undergraduate level mathematics, coupled with a number of studies pointing to GTAs' lacking Mathematical Knowledge of Teaching (MKT) (Kung, 2010; Kung & Speer, 2009; Speer, Gutmann, & Murphy, 2005) and abundantly held novice beliefs regarding the teaching and learning of mathematics (Gutmann,

2009; Hauk et al., 2009; Raychaudhuri & Hsu, 2012). Further, Speer, Strickland, and Johnson (2005) found that even experienced graduate students often lack knowledge of student learning of key ideas and have not developed strategies to support student learning of these topics. However, Kung (2010) found that it is possible for GTAs to develop rich knowledge of their students' mathematical understandings through professional development programs that emphasize student thinking.

These studies highlight a view that has become more widely accepted since first introduced by Shulman (1986): strong content knowledge alone is not sufficient for teaching mathematics, but must be accompanied by strong pedagogical knowledge and beliefs. Knowledge and beliefs about the teaching and learning of mathematics are developed through experience and professional development (Sowder, 2007). Since GTAs often lack teaching experience, these instructional qualities are fostered in GTAs primarily through professional development (Speer & Kung, 2007; Speer & Hald, 2008).

## **METHODS**

Data for this study comes from a large-scale national survey of mainstream Calculus I, where mainstream calculus refers to the calculus course that serve as prerequisites to typical upper-division mathematical sciences courses. This study included three surveys given to students (one at the beginning of Calculus I, one at the end of Calculus I, and one a year later), two surveys given to instructors (one at the beginning of Calculus I and one at the end of Calculus I), and one survey given to the calculus Course Coordinator, who acts as a institution representative regarding departmental programs targeting GTA PD. All surveys were completed online, and no incentives were given for completing the surveys. The surveys were sent to a stratified random sample of mathematics departments following the selection criteria used by the Conference Board of Mathematical Sciences in their 2005 study (Lutzer et al, 2007). There were 14,247 students and 1,149 instructors for whom there was either start-of-term survey data, end-of-term survey data, or both. Of these, 12,383 students were matched with 648 instructors with nearly complete data. In order to provide a description of the implementation and preparation of GTAs involved in the teaching of Calculus I, I conducted descriptive analyses of collected data. In the following section I present the results of these analyses, and then conclude with a discussion of the implications of these descriptive results, as well as next steps for this research.

## **RESULTS**

As shown in Table 1, 15.6 percent of the instructors were GTAs, 12.4 percent of all students were taught by a GTA. The percentage of students taught by a GTA increases slightly to 15.4% among students attending Ph.D.-granting institutions. In the 2005 College Board of Mathematical Sciences (CBMS) report, GTAs were determined to have taught eight percent of the 201,000 students enrolled in mainstream Calculus I and 22% of all mainstream Calculus I sections at Ph.D.-granting institutions (Lutzer et

al., 2007). Thus our data set shows that GTAs are teaching a larger percentage of all mainstream Calculus I students compared to the 2005 CBMS but a smaller percentage of students at Ph.D.-granting institutions.

Table 1 also shows that while the largest numbers of instructors were tenured faculty (33%) or other full time faculty (26%), other full time faculty taught the largest percentage of students (43%). In this study, other full time faculty include adjunct faculty, lecturers with security of employment, and non-tenure track teaching professors. This result shows that GTAs comprise a substantial percentage of Calculus I instructors and teach a substantial percentage of Calculus I students. In fact, GTAs comprise a larger percentage of Calculus I instructors and teach a larger percentage of Calculus I students than tenure-track faculty. In these frequencies, GTAs are the instructor on record. In this next analysis, I account for GTAs that led recitations.

Instructor Status	# Instructors	Percent	# Students	Percent
Tenure-track faculty	93	14.4	1373	11.1
Tenured faculty	215	33.2	3397	27.4
Other full-time faculty	170	26.2	5323	43.0
Part-time faculty	57	8.8	503	4.1
GTA	101	15.6	1540	12.4
Visiting/ Post-doc	12	1.9	247	2.0
Total	648	100	12,383	100

Table 1: The number of instructors and students taught by them, by instructor status.

As shown in Table 2, graduate students were employed by 62 institutions of the 65 Doctoral granting institutions involved in the study. Of these, 46.8% employed GTAs as the primary instructor for a Calculus I course only, 53.2% employed GTAs as recitation leaders only, and the remaining 19.4% employed GTAs both as primary instructors and as recitation leaders. Together these results show that GTAs are widely utilized by Doctoral granting institutions both as recitation leaders and as the primary instructor in Calculus I. This wide utilization leads one to ask in what ways GTAs are being selected or prepared for these roles – the following analysis answers this question.

Utilization of GTAs	Number of Institutions	Percent of institutions employing GTAs
GTAs lead recitation only	33	53.2
GTAs teach their own section only	12	19.4
GTAs do both	17	27.4
Total	62	100.0

Table 2: Number of institutions utilizing GTAs.

At these 62 institutions that utilize GTAs in some capacity, various practices geared toward the selection or preparation of GTAs were used, and to varying degrees of effectiveness. Table 3 shows that the most common programs for selecting or preparing GTAs are a seminar or class for the purpose of GTAs' professional development, some form of screening GTAs prior to assigning them to a recitation section, and faculty observation of GTAs for the purpose of evaluating their teaching, with over 70% of institutions using each of these methods for preparing their GTAs. Among the institutions utilizing these preparation/ selection methods, at least 70% of institutions said they were effective, with 83% saying that the seminar or class was effective.

Table 3 also shows that about half of the institutions have a program that pairs new GTAs with a faculty member, but only about 60% of these programs were said to be very effective or effective by the Course Coordinator. Additionally, about 40% of institutions have some other program for GTA mentoring or professional development, with 70% of these identified as effective. Research on K-12 professional development points to the important role that mentoring plays in teacher preparation, specifically in increasing teacher effectiveness and decreasing teacher attrition (Putnam & Borko, 2000; Sowder, 2007). However, without knowing the nature of the mentorship at these institutions is difficult to understand what role this played in GTA preparation.

GTA selection or preparation activity	Institutions	% institutions employing GTAs	% effective
Seminar or class for the purpose of GTAs professional development	47	75.8	83.0
Faculty observation of GTAs for the purpose of evaluating their teaching	47	75.8	70.2
Screen GTAs before assigning them to a recitation section	44	71.0	70.5
Pairs new GTAs with faculty members	33	53.2	60.6
Other program for GTA mentoring or professional development	27	43.5	70.4
Interview process to select prospective GTAs	21	33.9	76.2

Table 3: Frequency and effectiveness of activities to select or prepare GTAs from national sample.

## DISCUSSION

These survey results call for more research into the connections between GTA preparation and instructor and student success, and lay the foundation for this work. This analysis is the beginning of a larger project that draws on the survey data described above, as well as explanatory case studies (Yin, 2003) conducted at five doctoral granting institutions determined to be more successful than other institutions. Success was defined as a combination of student variables: persistence in Calculus as marked by stated intention to take Calculus II; affective changes, including enjoyment of mathematics, confidence in mathematical ability, interest to continue studying math; and passing rates. As part of the case studies we interviewed students, instructors, GTAs, GTA trainers, Course Coordinators, and administrators, observed classes; observed GTA training, and collected GTA training material, exams, course materials, and homework. Additionally, a follow up survey, in which GTAs were asked to describe and evaluate their preparation to teach, as well as answer questions regarding their beliefs about teaching mathematics, was sent to all current GTAs at the five selected institutions. Initial analyses of this multimodal data set point to a strong connection between student persistence in the calculus sequence and instruction by a GTA (Rasmussen, Ellis, & Bressoud, 2013). However, among the five successful institutions with high student persistence, GTAs received extensive preparation for their roles in teaching Calculus I (Rasmussen, Hsu, Burn, & Melhuish, 2013). Together, these results suggest a relationship between GTA PD and student success that needs to be further examined.

## Acknowledgments

Support for this work was funded by the National Science Foundation under grant No. 0910240. The opinions expressed do not necessarily reflect the views of the foundation.

## References

- Ball, D. L., Thames, M. H., & Phelps, G. (2008). Content knowledge for teaching: What makes it special? *Journal of Teacher Education*, *59*, 389-407.
- Belnap, J. K., & Allred, K. N. (2009). Mathematics teaching assistants: Their instructional involvement and preparation opportunities. In L. Border, N. Speer, & T. Murphy (Eds.), *Studies in graduate and professional student development: Research on graduate students as teachers of undergraduate mathematics*, *12* (pp. 11-38). Stillwater, OK: New Forums Press.
- Bressoud, D., Carlson, M., Mesa, V., & Rasmussen, C. (2013). The calculus student: insights from the Mathematical Association of America national study. *International Journal of Mathematical Education in Science and Technology*, *44*(5), 685-698.
- Gutmann, T. (2009). Beginning graduate student teaching assistants talk about mathematics and who can learn mathematics. In L. Border, N. Speer, & T. Murphy (Eds.), *Studies in Graduate and Professional Student Development: Research on Graduate Students as*



- Teachers of Undergraduate Mathematics, 12* (pp. 85-96). Stillwater, OK: New Forums Press.
- Hauk, S., Chamberlin, M., Cribari, R., Judd, A., Deon, R., Tisi, A., & Khakakhail, H. (2009). A case story: Reflections on the experiences of a mathematics teaching assistant. In L. Border, N. Speer, & T. Murphy (Eds.), *Studies in Graduate and Professional Student Development: Research on Graduate Students as Teachers of Undergraduate Mathematics, 12* (pp. 39-62). Stillwater, OK: New Forums Press.
- Hill, H. C., Ball, D. L., & Schilling, S. G. (2008). Unpacking pedagogical content knowledge: Conceptualizing and measuring teachers' topic-specific knowledge of students. *Journal for Research in Mathematics Education, 39*(4), 372-400.
- Johnson, E. M. S., & Larsen, S. P. (2012). Teacher listening: The role of knowledge of content and students. *Journal of Mathematical Behavior, 31*, 117-129.
- Kung, D. T. (2010). Teaching assistants learning how students think. In F. Hitt, D. Holton, & P. W. Thompson (Eds.), *Research in collegiate mathematics education VII* (pp. 143-169). Providence, RI: American Mathematical Society.
- Kung, D., & Speer, N. (2009). Mathematics teaching assistants learning to teach: Recasting early teaching experiences as rich learning opportunities. In L. Border, N. Speer, & T. Murphy (Eds.), *Studies in Graduate and Professional Student Development: Research on Graduate Students as Teachers of Undergraduate Mathematics, 12* (pp. 133-152). Stillwater, OK: New Forums Press.
- Lutzer, D., Rodi, S. B., Kirkman, E. E., & Maxwell, J. W. (2007). *Statistical abstract of undergraduate programs in the mathematical sciences in the United States: Fall 2005 CBMS survey*. Providence, RI: American Mathematical Society.
- National Science Board (NSB). (2008). *Science and engineering indicators 2008*. Arlington, VA: National Science Foundation.
- President's Council of Advisors on Science and Technology (PCAST). (2012). *Engage to excel: Producing one million additional college graduates with degrees in science, technology, engineering, and mathematics*. Washington, DC: The White House.
- Putnam, R. T., & Borko, H. (2000). What do new views of knowledge and thinking have to say about research on teacher learning? *Educational Researcher, 29*(1), 4-15.
- Rasmussen, C., Ellis, J., & Bressoud, D. (2014). *Who is switching out of STEM and why?* Manuscript submitted for publication.
- Rasmussen, C., Hsu, E., Burn H., & Melhuish, K. (2013). *Features and practices of successful calculus programs: Insights from case studies at seventeen institutions*. Presentation at the Association of American Colleges and Universities (AACU) conference: Transforming STEM Education: Inquiry, Innovation, Inclusion, and Evidence, San Diego, CA.
- Raychaudhuri, D., & Hsu, E. (2012). A longitudinal study of mathematics graduate teaching assistants' beliefs about the nature of mathematics and their pedagogical approaches toward teaching mathematics. In S. Brown, S. Larsen, K. Marrongelle, & M. Oehrtman (Eds.), *Proceedings of the 15<sup>th</sup> Conference on Research in Undergraduate Mathematics Education* (pp. 522-525). Portland, OR: SIGMAA.

- Seymour, E., & Hewitt, N.M. (1997). *Talking about leaving: Why undergraduates leave the sciences*. Boulder, CO: Westview Press.
- Shulman, L. S. (1986). Those who understand: Knowledge growth in teaching. *Educational Researcher*, 15(4), 4-14.
- Sowder, J. T. (2007). The mathematical education and development of teachers. In F. K. Lester, Jr. (Ed.), *Second handbook of research on mathematics teaching and learning* (pp. 157-223). Charlotte, NC: Information Age Publishers and National Council of Teachers of Mathematics.
- Speer, N., Gutmann, T., & Murphy, T. J. (2005). Mathematics teaching assistant preparation and development. *College Teaching*, 53(2), 75-80.
- Speer, N., & Hald, O. (2008). How do mathematicians learn to teach? Implications from research on teachers and teaching for graduate student professional development. In M. Carlson & C. Rasmussen (Eds.), *Making the connection: Research and teaching in undergraduate mathematics education* (pp. 305-317). Washington, DC: The Mathematical Association of America.
- Speer, N., Strickland, S., & Johnson, N. (2005). Teaching assistants' knowledge and beliefs related to student learning of calculus. In G. M. Lloyd, M. Wilson, J. L. M. Wilkins, & S. L. Behm (Eds.), *Proceedings of the 27<sup>th</sup> annual meeting of the North American Chapter of the International Group for the Psychology of Mathematics Education*. Roanoke, VA: Virginia Tech.
- Wagner, J. F., Speer, N. M., & Rossa, B. (2007). Beyond mathematical content knowledge: A mathematician's knowledge needed for teaching an inquiry oriented differential equations course. *Journal of Mathematical Behavior*, 26, 247-266.
- Yin, R. (2003). *Case study research: Design and methods*. Thousand Oaks, CA: Sage Publications.
- Zazkis, R., & Zazkis, D. (2011). The significance of mathematical knowledge in teaching elementary methods courses: Perspectives of mathematics teacher educators. *Educational Studies in Mathematics*, 76, 247-263.

# MATHEMATICAL PRACTICES AS UNDER-DETERMINED LEARNING GOALS: THE CASE OF EXPLAINING DIAGRAMS IN DIFFERENT CLASSROOM MICROCULTURES

Kirstin Erath, Susanne Prediger

TU Dortmund University, Germany

*More and more curricula and standards worldwide specify not only mathematical contents as learning goals but also process-oriented goals for mathematical practices. But even with clear formulations in the formal curricula, the implemented curricula of these mathematical practices can diverge substantially for different classroom cultures, as this research report shows for the discursive practice of “explaining”. By adopting an interactionist perspective, we compare the implemented curriculum in different video- recorded classroom microcultures. The comparative case study on the topic “explaining diagrams” in grade 5 shows that explaining practices and their underlying norms differ considerably with respect to explanandum, repertory of explanans in epistemic modes, and participation structures.*

## COMPARING IMPLEMENTED CURRICULA FOR DISCOURSIVE MATHEMATICAL PRACTICES

As process standards on mathematical practices gain an increasing importance in *written curricula* and standards (e.g., CCSS, 2010; KMK, 2004), it is time to ask whether the expectations concerning these learning goals are well defined and whether the *implemented curricula* are comparable in different classrooms. Although some gaps between written and implemented curricula can be found for many learning contents (e.g., van den Akker, 1998), the question is especially important for learning goals that are mainly *orally* established in classroom discourses (not in textbooks), such as explaining, describing, and arguing (that appear as “communicating,” for example, in the formal curricula).

Accounting for this *mainly oral status* of mathematical discourse practices, we adopt an interactionist perspective and conceptualize them as being established in the classroom *interaction* (Yackel, 2004). Comparing the implemented curricula for different classroom microcultures therefore means reconstructing the interactively established practices and underlying sociomathematical norms in the interactions.

Our video study focuses on the exemplary discourse practice *explaining*, chosen due to the highest frequency of appearance in the observed classroom discourse in five grade 5 classrooms. In this paper, we use a comparative case study on explaining diagrams to show big differences between two implemented curricula. It raises questions about comparability of learning opportunities for all children, missing preconditions for comparable attained curricula, and difficulties for justice in central exams on a state level.

## THEORETICAL BACKGROUND

### Explaining as a classroom practice from an interactionist perspective

In the interactionist perspective, *explaining* is conceptualized as a mathematical practice being interactively established in a classroom microculture and regulated by specific sociomathematical norms (Yackel, 2004). *Learning to explain* in the interactionist approach means successively participating in the explaining practices. The constructs of microculture, norms, and practices allow a shift from evaluating students' utterances as (pseudo-objectively) valid/invalid explanations to those *matching/mismatching* the classroom microculture's norms and practices. This allows capturing of the implemented curriculum in terms of expectations and learning opportunities relative to each classroom. Whereas preceding empirical studies explored the interactionist mechanisms of how practices and norms can be established in principle, our current study intends to specify the explaining practices by systematically taking into account content and epistemic modes.

### Distinctions for *explanans* and *explanandum* in the epistemic matrix

We define explaining as a discourse practice that aims at building and connecting knowledge in a systematic, structured way by linking an *explanandum* (the issue that needs to be explained) to an *explanans* (by which the issue is explained). Besides explaining-why, it includes explaining-what and explaining-how. In Prediger and Erath (2014), we developed a conceptual framework for clarifying the addressed mathematical core of the explaining practices in detail. Adopting an epistemological perspective, explaining practices can be distinguished by different logical levels and epistemic modes in the so-called epistemic matrix (see Figure 1). The rows distinguish the *explanandum in 7 logical levels*: the four conceptual levels comprise concepts (categories such as “bar chart”), semiotic representations (here the diagram itself), mathematical models (addressing the relation between reality and mathematical objects/statements), and propositions (mathematical patterns, statements, or theorems); the three procedural levels comprise procedures (such as a general way of drawing a diagram), conventional rules (e.g., “frequencies on vertical axis”), and concrete solutions (such as individual solutions of a task). The columns of the epistemic matrix address the *explanans in six different epistemic modes*: “labelling & naming” is the only mode that can be addressed by a single word (e.g., “maximum”).

The mode “explicit formulation” is a linguistically elaborate way to treat an explanandum as it includes definitions and formulating patterns or procedures. The mode “exemplification” addresses examples and counterexamples. The mode “meaning & connection” comprises all aspects of an explanandum that bridge to another level or mode, for example pre-existing knowledge (e.g., meanings, arguments, reasons). The mode “purpose” belongs to a pragmatic approach of explaining by its inner mathematical or everyday functions, for example “by a diagram, we see pattern more clearly.” The mode “evaluation” appears in the context of presenting solutions in class.

Explanans in epistemic modes	Labelling & naming [l]	Explicit formulation [f]	Exemplification [e]	Meaning & connection [m]	Purpose [p]	Evaluation [ev]
<b>Explanandum in logical levels</b>						
<b>Conceptual levels</b>						
Concepts [C]			#1	#4/6 Markus	#2 Nikolas	#1 #4/6 Markus
Semiotic representations [R]						
Models [M]						
Propositions [PO]						
<b>Procedural levels</b>						
Procedures [P]						
Concrete solutions [S]						
Conventional rules [RU]						

Figure 1: Epistemic matrix for distinguishing explanans and explanandum in explaining practices

In our empirical approach, each explanation that is demanded or given in a classroom interaction can be characterized by its so-called *epistemic field*, that is, the combination of addressed logical level and epistemic mode. Figure 1 contains an exemplary navigation pathway of Episode 1 (see below) in which the teacher addresses the fields – concepts/semiotic representations – “exemplification/purpose” (shortened [CRep]) by asking the class why you can find diagrams more often than lists in printed media. Here, students answer in the expected fields.

## DESIGN AND METHODOLOGY OF THE STUDY

The comparison of curricula was led by the following *research questions*:

- Q1. Which epistemic fields are addressed in explaining practices?
- Q2. How do the explaining practices differ in the navigation between epistemic fields?
- Q3. How do students’ learning opportunities for explaining practices differ in terms of participation structures?

*Data corpus.* In the larger project Interpass, video data was gathered in 10 x 12 lessons (of 45–60 minutes each) in five different grade 5 classes. The data corpus also comprised students’ and teachers’ written products and classroom materials. The small comparative case study presented in this paper focuses on the statistical learning content “diagrams” which was treated in each class in 3–5 lessons. We specifically focus on two classrooms with comparable textbook and student populations; altogether 383 min. of video material, including 111 min. of explaining practices.

*Data analysis in four steps.* (1) All video data were coded by the applied teaching methods, the epistemic field in which the statistical content “diagrams” was treated, and the emergence of common discursive practices of explaining. (2) All 18 episodes with a common explaining practice in classroom discourse were transcribed and carefully analyzed within their interactive structure. Not only teachers’ moves, but also students’ answers were classified with respect to the addressed epistemic field and condensed in navigation pathways (see Fig. 1, Fig. 3, and Prediger & Erath, 2014). (3) The navigation pathways in both scenes were contrasted and compared to other scenes for reconstructing typical profiles. (4) For comparing students’ learning opportunities, categories were specified for capturing participation structures.

## EMPIRICAL CASE STUDY: CONTRASTING TWO CLASSROOMS

### Overview of all addressed epistemic fields

Figure 2 shows all the epistemic fields addressed at a certain moment while explaining diagrams. In this first approach to teachers' questions and students' utterances and written tasks, no major differences between the two classrooms can be found.

Explanans in epistemic modes	Labelling & naming [l]	Explicit formulation [f]	Exemplification [e]	Meaning & connection [m]	Purpose [p]	Evaluation [ev]
<b>Explanandum in logical levels</b>						
<b>Conceptual levels</b>						
Concepts [C]	Light Green	Dark Blue	Light Green	Dark Blue	Light Green	Dark Blue
Semiotic representations [R]	Light Green	Dark Blue	Light Green	Dark Blue	Light Green	Dark Blue
Models [M]			Dark Blue		Light Green	Dark Blue
Propositions [PO]						
<b>Procedural levels</b>						
Procedures [P]			Light Green	Dark Blue	Light Green	Dark Blue
Concrete solutions [S]	Light Green	Dark Blue	Light Green	Dark Blue	Light Green	Dark Blue
Conventional rules [RU]						

Figure 2: Covered epistemic fields in the classroom of Mr. Maler (brighter green) and Mr. Schroedinger (darker blue)

### Deeper analysis of explaining practices

Although on a surface level, both classrooms treat the same learning content “diagrams” and “explaining” in similar epistemic modes, the deeper analysis shows large differences that are illustrated by the two following.

#### *Episode 1: Mr. Schroedinger's classroom: function of diagrams*

The teacher (TE) Mr. Schroedinger introduces the topic diagrams with a slide full of examples and constitutes an explanandum on the conceptual level by asking for the function of diagrams [the abbreviated epistemic field is shown next to the transcript].

1	TE	[...] WHY they're doing quite frequently in printed media but also um on TV in the news, um why they're not giving a LIST like that [...]	[CRep]
2	Nik	um because maybe because this CATCHES one's eye much faster and um well that you can SEE this faster; so that something is BIGGER; because this is also bigger from its SIZE. So it's MORE because it's BIGGER from its size.	[CRpm]
4	Mar	Because you can CATCH it very fast. For example um now up RIGHT. I think there are such PERCENTAGES; because (that they) CATCH that well it's actually even BETTER than this; (also how many) PEOPLE;	[CRepM]
6	Mar	How many SIBLINGS they have, because then in parts they would maybe have to always go THROUGH our classroom that small	[CRepM]
9	TE	THIS exactly meets the point, these two utterances. THEREFORE you normally do it in the form of such diagrams, because of the clarity actually [...]	[CRep]

Nikolas (#2) follows this mode “purpose”, but additionally offers a first interpretation of a diagram (“meaning & connection”). The teacher calls further students before summarizing their contributions. Markus first refers to the “purpose” (#4), then to

“meaning” (#4–#6), and finally gives an “exemplification”. The teacher asks another student who has nothing to add (non-printed #7/8), then summarizes by recalling those parts of students’ utterances that refer to the epistemic modes he initially addressed, namely “purpose / exemplification”. The mode additionally addressed by Nikolas and Markus, “meaning & connection”, is simply dropped without negative evaluation (whereas in other episodes, these kinds of students’ extensions of modes are welcomed by the teacher). The complete navigation pathway is printed in Figure 1. Episode 1 continues with the teacher’s initiation of students’ individual seat work. Students’ written explanations for the difference between diagram and pictogram are later discussed extensively in a whole-class discussion.

The briefly presented Episode 1 could be reconstructed as typical for explaining practices that are often established in this classroom: typical is the location of the explanandum on the conceptual level, the acceptance of different epistemic modes as explanans, and the broad participation of students without immediate single evaluation (cf. Prediger & Erath, 2014, for further examples of the same classroom). In this way, the practice of explaining is constituted as a topic to be learned. Typical for the participation structure in this classroom is also that all contributions are acknowledged and treated as (at least partly) correct.

*Episode 2: Mr Maler’s classroom: distinguishing names and drawing procedures*

Episode 2 starts when the class had collected frequencies of favorite sports and represented them on the blackboard by tally marks and frequency tables.

1	TE	[...] Do you KNOW diff- do you KNOW diagrams? What ARE diagrams, which kinds ARE there, how can this HELP us here; this would be interesting for me now; let’s START with- WHO of you actually knows diagrams; MIRKO.	[CRflep]
2	Mir	um BAR CHART does exist.	[CRI]
3	TE	BAR CHARTS, YES bar charts DO exist; what er MAKES UP a bar chart as a bar chart? or differently; how does it LOOK like; Mirko, explain, you said that-	[CRf]
4	Mir	There are no lines of the numbers drawn, but then like well like BARS so to say.	[CRfe]

In #1, the teacher constitutes an explanandum on the conceptual level (concepts/semiotic representations: “diagrams” in general). He initially allows a wide range of epistemic modes: “labelling & naming/explicit formulation/exemplification/purpose”. Mirko (#2) addresses the mode “labelling & naming” by giving only one keyword. In his reaction (#3), the teacher narrows his expectations for epistemic modes and asks Mirko for an “explicit formulation”. Mirko fulfills the expected mode and contours his explanation by contrasting bar charts from tally marks (“no lines of the numbers”, #4). Mr. Maler’s next question shifts the explanandum from the conceptual to the procedural level:

5	TE	Yes, CORRECT; and how, look HOW are they drawn, could you explain to me, how I could DO it maybe for this example	[PSf]
---	----	---	-------

- 8 Mir Well, if you would um well, also would write it down like this (only) put away the numbers. [PSf]
- 14 Mir um, well, than you can, well I know (I think there are) TWO bar charts, one up like this and one like er then horizontally [CRf]

Mirko follows the teacher’s navigation after short questions (non-printed, #6/7) and starts his explanation (#8) by referring to the frequency tables on the blackboard. The teacher materializes his description by drawing on the blackboard (non-printed #9–13). Mirko interrupts his explanation of the procedure and navigates back to the conceptual level [CRf] in #14 by mentioning two kinds of charts with horizontal or vertical bars (that have different names in German: bar chart versus “column chart”).

- 15 TE Very NICE, and now you see we get down to it, MIRKO, ONE of them is called bar chart like you SAID, and the OTHER ONE isn’t called bar chart, this we call, does anybody know that? DARIA. [CRI]
- 16 Dar Well, I mean, that, um, this other diagram is often used for watching, for example in politics, for the PARTIES, they go up, or [...] [CRepm]
- 17 TE Yes, it is USED quite often at elections; you’re completely RIGHT; but first I would like- we maybe just- about to come back to this as well; er to respond to MIRKO again, [...] if we’re doing it like Mirko just SAID, first write one below the other and then the charts have to- HOW do the charts have to be put there; SO THAT it somehow works; KOSTAS. [CI / Pf]
- 18 Kos HORIZONTALLY. [CI / Pf]
- 19 TE HORIZONTALLY, EXACTLY! THEN! you really call it a bar chart; ONLY this is a bar chart. [CRle]

Mr. Maler continues (in #15) with the explanandum constituted by Mirko, but instead of explaining the meanings, he asks for the correct name of the vertical chart [CRI]. Daria (in #16) does not follow his navigation into the mode “labelling & naming” but mainly refers to “purpose” and “meaning”. The teacher evaluates her answer as not matching the intended line of thought and delays it to later (#17). He comes back to his question and navigates it into the field [Pf], the “explicit formulation” for the drawing procedure. Kostas (#18) follows this navigation and names the direction of drawing. This is positively evaluated and the teacher himself answers the question on the names (#19 and later).

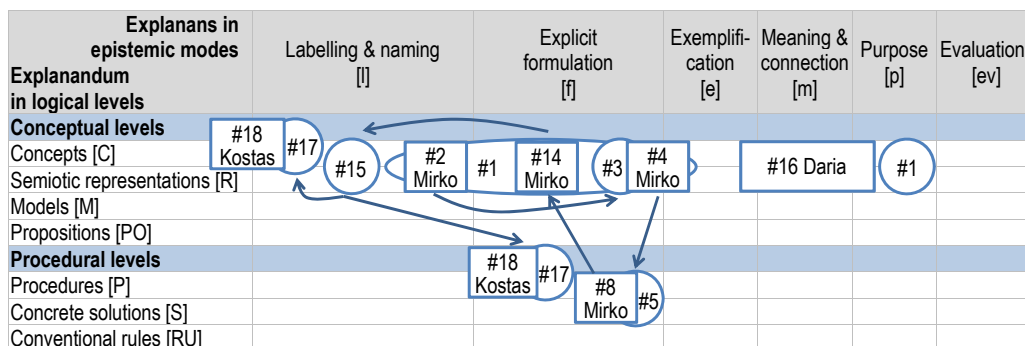

Figure 3: Navigation pathway for Episode 2



## Comparing the explaining practices

The briefly presented Episode 2 illustrates typical explaining practices in Mr. Maler's classroom that can be reconstructed as differing in several ways from those found in Mr. Schroedinger's classroom:

- *Explanandum*: Both teachers often treat concrete solutions of tasks, but differ when generalizing: Rather than staying on the conceptual level like Mr. Schroedinger, Mr. Maler shifts the explanandum between conceptual and procedural levels, usually with a strong emphasis on the level of general procedures.
- *Explanans*: Whereas Mr. Schroedinger accepts a large range of epistemic modes, Mr. Maler rejects students' answers in non-expected epistemic modes and constitutes a funnel pattern by successively narrowing his expectations to one or two selected epistemic modes.

Contrasting Mr. Maler's and Mr. Schroedinger's classrooms on explaining diagrams shows that there are distinct profiles for explaining: whereas the explaining practice established in Mr. Maler's classroom can be characterized by the overall profile "explaining procedures with narrow expectations of specific epistemic modes," Mr. Schroedinger's interaction establishes an overall profile of "explaining concepts and models with a wide variety of epistemic modes."

## Comparing participation structures, resp. learning opportunities

The comparison of the two episodes shows not only differences in explanans and explanandum, but also different learning opportunities in terms of different participation structures: whereas Mr. Maler's typical IRE-sequences often work with one selected student (in Episode 2 with Mirko) and many teacher's explanations, Mr. Schroedinger establishes "IRRRRE-sequences" with many students' replies and reduces his contributions to initiations and summarizing evaluations for all replies.

These participation structures are reflected in the complete unit. In Mr. Maler's classroom, approx. 123 minutes are spent on the topic diagrams, of which about 20% is used for explaining, all of it in oral classroom discourse. But only in about 18% of this explaining time, the students actively explain; the rest is taken by the teacher. In contrast, in Mr. Schroedinger's classroom approx. 260 minutes are spent on diagrams. The 33% of time spent on explanations specifically include about 48 minutes of written explanations in which all students are active. Hence, students are actively involved in 76% of the explaining time.

Although these percentages of a very limited data set can only be interpreted as a very first tendency, these significant differences show that capturing learning opportunities goes beyond the navigation pathways. In our ongoing data analysis, the following categories turned out to be important for analyzing the participation structure: students' active involvement in explaining practices, distinction between oral and

written activities and teaching methods that engage all or only some students, and, finally, division of labor and agency for different epistemic fields.

## DISCUSSION AND OUTLOOK

Beyond the close comparability of the classrooms in terms of textbook, student population, and shared formal curriculum, *two divergent profiles* of explaining practices can be reconstructed: “explaining procedures with narrow expectations of specific epistemic modes” versus “explaining concepts and models with a wide variety of epistemic modes.” Hence, it must be doubted whether the students in both classrooms get access to the *same* practice that is mentioned in the written curriculum.

Furthermore, the distinct implemented curricula on explaining are shaped by different participation structures: in Mr. Maler’s classroom, explaining is mainly used by the teacher as a *learning medium* for reaching content goals, whereas in Mr. Schroedinger’s classroom, explaining appears as a *learning content* on which the students get wide opportunities to work, in oral and written form.

Although the ongoing video study will continue to investigate and compare other teaching units for constructing a wider picture, we can already conclude that since already the *implemented* curricula are so different between very comparable class-rooms, we should not be too optimistic for the *achieved* curriculum. As a further consequence, it is an issue of justice to leave the assessed curriculum quite open: How narrow is the norm of explaining that is assessed? And how does it match to the one implemented in the classroom? As a whole, the identified differences in the implementation of the same formal curriculum call for the necessity of widespread professional development for teachers.

**Remark:** The research project Interpass – Interactive procedures of establishing matches and divergences for linguistic and microcultural practices – is funded by the German ministry BMBF (grant 01JC1112). We are conducting it with Anna Vogler, Uta Quasthoff, and Vivien Heller.

## References

- KMK. (2004). *Bildungsstandards im Fach Mathematik für den mittleren Schulabschluss: Beschluss der Kultusministerkonferenz vom 3.12.2003*. München: Luchterhand.
- National Governors Assoc. Center for Best Practices, Council of Chief State School Officers (CCSS). (2010). *Common core state standards for mathematics*. Washington, DC: CCSS.
- Prediger, S., & Erath, K. (2014). *Content or interaction, or both? Synthesizing two German traditions in a video study on learning to explain*. Manuscript in preparation.
- van den Akker, J. (1998). The science curriculum: Between ideals and outcomes. In B. Fraser & K. Tobin (Eds.), *Design approaches and tools in education and training* (pp. 1-14). Dordrecht: Kluwer.
- Yackel, E. (2004). Theoretical perspectives for analyzing explanation, justification and argumentation in mathematics classrooms. *Journal of the Korea Society of Mathematical Education*, 8(1), 1-18.

# ON THE STRUCTURE OF SECONDARY HIGH-SCHOOL TEACHERS' BELIEF SYTEMS ON CALCULUS

Ralf Erens, Andreas Eichler

University of Education, Freiburg, Germany

*A teacher's instructional planning that is enacted in his classroom practice and that potentially impact on his students' knowledge and beliefs could be understood as an individual belief system dependent from his actual teaching and learning experience. Individual belief systems might be contradictory when we regard different teachers or one teacher concerning different mathematical disciplines. For this reason, this report focuses on thirty teachers' beliefs about their teaching of a specific mathematical domain, i.e. calculus that is a central part of the (German) curriculum at upper secondary level. After a brief outline of the theoretical framework and methodology of this research project, results of the qualitative reconstruction of different aspects of teachers' belief systems on calculus will be explained.*

## INTRODUCTION

Beliefs concerning both mathematics and teaching and learning of mathematics are a crucial part of the professional competence of mathematics teachers (Felbrich et al., 2012). The importance of gaining knowledge towards mathematics teachers' thinking or beliefs has been emphasised by many researchers in mathematics education in various settings and projects because teachers' beliefs about mathematics and the teaching and learning of mathematics have a high impact on their instructional practice (Philipp, 2007; Eichler, 2011, Felbrich et al., 2012), and, potentially impact on their students' learning (Stein et al. 2007). However, the vast body of research on teacher beliefs rarely considers that similar to the classification of mathematical subjects into fields such as algebra or probability theory – teachers' beliefs on different mathematical domains such as geometry, stochastics or calculus may vary and may be associated with specific beliefs (Franke et al., 2007).

For this reason we focus on domain-specific beliefs of 30 secondary teachers referring to calculus, which is a central part of the German secondary curriculum, and the teaching and learning of calculus. Our specific interest in this paper concerns the structure of belief systems, i.e. the set of beliefs and different relations between beliefs that characterise calculus teachers' instructional planning (Eichler, 2011). Before we address the aforementioned reconstruction and relations, an outline is given about the theoretical framework of this research project and a brief description of those parts of the method being relevant for this paper. Finally we conclude the paper by reflecting on the main results and discuss possible directions of further research.

## THEORETICAL FRAMEWORK

The main constructs of our theoretical framework are teaching goals and teachers' beliefs. Firstly, according to Pajares (1992), we understand the term beliefs as an individual's personal conviction concerning a specific subject, which shapes an individual's ways of both receiving information about a subject and acting in a specific situation. We further follow Green (1971) referring the internal organisation of beliefs in a belief system involving the distinction of central beliefs, i.e. strongly held beliefs, and peripheral beliefs referring to an individual's belief system of lesser importance. The construct of belief systems also involves that beliefs are organised in clusters that are quasi-logically connected, which potentially includes also connections of beliefs that seem contradictory (ibid.). Finally, Green (ibid.) distinguishes primary beliefs and subordinated (derivative) beliefs in which enacting derivative beliefs serve as a means to an end for achieving primary beliefs.

According to the framework of Hannula (2012), both belief systems and goals are parts of mathematics-related affect that consists of cognitive, motivational and affective aspects. Hannula (ibid.) further describes beliefs or rather belief systems as a psychological aspect of mathematics-related affect as a trait and, hence representing a disposition. In contrast, he describes goals as a psychological aspect of mathematics-related affect as a state. Thus, goals refer to a "decision making during teaching" (Schoenfeld, 2011, p. 460). In contrast to the distinction of affect as a trait and affect as a state, we follow the so called Rubicon-model of Heckhausen and Gollwitzer (1987) in which goals are understood in a broader sense constituting a teacher's decision making (state of awareness referring to the choice of goals) before passing the Rubicon, i.e. when a teacher plans his classroom practice, and after passing the Rubicon, i.e. the teacher's decision making during his classroom practice (state of awareness when enacting the goals).

Following this framework, we understand teaching goals as specific form of beliefs and, in the same way, a system of different but related teaching goals as a teacher's belief system. These teaching goals are developed by a teacher when he plans his classroom practice and they are potentially enacted in his classroom practice. Finally, the enacted goals could be more or less changed based on the teachers' experience referring to their classroom practice and their students' learning (Stein et al., 2007).

To describe clusters of teaching goals or rather clusters of beliefs we refer, finally, to four so called mathematical world views proposed by Grigutsch et al. (1998) that are often used to conceptualise overarching teaching goals (e.g. Felbrich et al., 2012), i.e.

- a formalist (world) view in which mathematics is characterized by a logical and formal approach and in which accuracy and precision are important.
- a process-oriented view in which mathematics is defined as a heuristic and creative activity that allows solving problems using individual ways.
- an instrumentalist view in which mathematics is seen as a collection of rules and procedures to be memorized and applied according to the given situation.

- an application oriented view that accentuates the utility of mathematics for the real world.

In their research that was based on a questionnaire and that involved 400 German secondary teachers, Grigutsch et al. (1998) yield correlations between the four aspects of their mathematical world views as described in Figure 1.

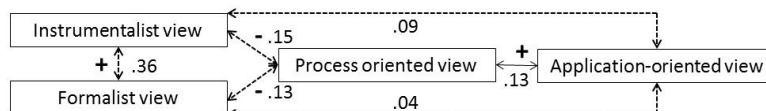

Figure 1: Correlations between the four world views.

On the basis of our theoretical framework the main focus of this paper is to describe the structure of calculus teachers' teaching goals beyond correlations, involving the identification of central and peripheral goals as well as primary and derivative goals.

## METHOD

The sample for this study consists of 30 calculus teachers divided into three subsamples: 10 pre-service teachers, 10 teacher trainees and 10 experienced teachers. Since we do not focus on the development of teachers' beliefs (for this aspect see Erens & Eichler, 2013), in this paper, we make no distinction between the different grades of the teachers' experience. The teachers who participated in our study were recruited from different universities, teacher training colleges and schools across the south-western part of Germany. However, our sample is a theoretical sample (Glaser & Strauss, 1967), but not a representative sample.

We used semi-structured interviews for data collection. Topics of these interviews were several clusters of questions that concern the content of calculus teaching, the related goals, and reflections on the nature of calculus, on the possible influence of technology on the students' learning, or textbook(s) used by the teachers. Further, we use prompts to provoke teachers' beliefs. These prompts consist of fictive or real statements of teachers or students representing one of the four mathematical world views or tasks of textbooks that also represent the four world views.

For analysing the data, we used a qualitative coding method (Mayring, 2010) that is close to grounded theory (Glaser & Strauss, 1967). The codes gained by interpretation of each episode of the verbatim transcribed interviews indicate goals of calculus teaching. We used deductive codes derived from a theoretical perspective (cf. Grigutsch et al., 1998) and inductive codes for those goals we did not deduce from existing research concerning calculus education. The codings were conducted by at least two persons and we proved the interrater reliability to show an appropriate value.

## RESULTS

The first step of analysing the structure of the teachers' system of goals referring to calculus was to identify central and peripheral teaching goals. We understand teaching goals to be central for a teacher if he reports these goals coherently through the whole

interview and if he illustrates his goals with concrete examples of his classroom practice or concrete tasks. Since we described the process of identifying central and peripheral goals in detail elsewhere (Eichler & Erens, 2014), in this paper we only postulate different grades of centrality. Thus, we start with two central goals of Mr. P.

Mr. P.: Teaching calculus to me means to focus on the underlying concepts, discover connections between concepts and enable students to solve problems using individual ways. That's really important to me and I would like to emphasize this point. But, as I said before, this aspect is always connected with applications on a task-level.

The application-orientation is a central overarching teaching goal of Mr. P that is in close proximity to the process-orientation. This relation between these two central goals is in line with the results of Grigutsch et al. (1998). However, referring to our whole sample, the nature of proximity of these two overarching teaching goals varies individually.

For Mr. P both views are inextricably intertwined and are, thus, *coordinated*. For other teachers application-orientated goals are *subordinated*, since for them the integration of applications as a principle of learning calculus is for reasons of student motivation:

Mr. A.: I quite agree with the emphasis on applications in the given example. That is certainly a way to motivate them (students), but nevertheless one should not reduce genuine calculus or the teaching of calculus to that topic.

Again other teachers reckon that integrating real-world problems is an explicit part of their system of goals to which further goals are subordinated, e.g. process-oriented goals, or to which further goals are *super-ordinated*, e.g. goals representing the formalist view:

Mr. B.: Examples for applications are quite suitable here, and with applications I always associate modelling of real data, [...] increasingly introducing relevant applications into lessons may, for the students, succeed in a deeper insight into the concepts and ideas of calculus.

Although sometimes coordinated, sometimes subordinated and sometimes super-ordinated, within our data set the application-oriented and also process-oriented goals can be considered to have a certain "psychological strength" (Green, 1971, p. 47) and can thus be attributed in any case some degree of centrality in the respective teachers' belief system. According to Green's dimensions and the results of Grigutsch et al. (1998) one might hypothesize that particularly application-oriented goals that are central imply that teachers holding these goals rather see formalist aspects in calculus teaching as less essential or even contradict these. Though some teachers in our sample see formalist features of calculus concepts as a high barrier for student learners (mostly on a symbolical level), a general conclusion that application- or process-oriented problems are implicitly of higher importance than formality and logic cannot be drawn as the following quotations demonstrate:

Mr. A: Calculus is more than just dealing with application-oriented tasks. Then, for example, one would not regard the precision and exactness of calculus and use applications as a means to an end.

Mr. E: Problem-solving in calculus to me means: start with some kind of application in order to motivate students but then we first develop the formal and precise background we need as a sound footing before students can address more complex problems individually.

For these two teachers application-oriented goals and goals representing the formalist view are related. In the reverse direction, however, half a dozen teachers, who hold a consistent formalist view on calculus, either do not mention applications at all or mention these as a peripheral goal on the level of (given) textbook & exam tasks.

In order to reconstruct a teacher's belief system with any degree of credibility, we need various evidence emerging in different parts of the interview from which to draw these inferences. This consideration leads to the need to describe not only what a teacher believes about calculus but how the various goals are related to each other. So far we have described relations like coordination, subordination or super-ordination. However, in our data sample there is some evidence that individual teachers arrange their goals and beliefs into organized systems that make sense to them.

Mr. G1: Well, I daresay I could do calculus at school with a more theoretical and formal approach – similar to introducing concepts in algebra and topology. Maybe for some it would make things easier, but this will probably not be possible to implement in most courses

Mr. G2: I don't emphasize the formal derivation of the integral with limits of upper and lower sums any more. From my own teaching orientation this (formal) prompt you showed me is absolutely congruous with my own approach to teach the integral. With logical rigour and formal exactness one often scares off the students. Therefore I demonstrate one example at the end but I do not let the students do these limits of sums in my lessons anymore.

Throughout the whole interview these two teachers (G1 trainee, G2 experienced) explicitly mention the central role of exactness and logical rigour as necessary ingredients of secondary level calculus courses. The two quotations however seem to confirm that different belief clusters may have a quasi-logical structure (cf. Green, p.44). The (self-)reported incongruity between instructional goals and the situation encountered in the classroom can be characterized as a conflict of goals. This incongruity may be “an observer's perspective that does justice neither to the complexity of teaching, nor to the teachers' attempts to relate sensibly to this complexity” as Leatham (2006, p. 95) and Skott (2009, p. 44) have tried to explain. Regarding our underlying framework, these remarks fit in with transformation process (i.e. passing the Rubicon) between intended and enacted teaching goals perceivable in the data.

As this report focuses on teachers' beliefs towards calculus, which is, in Germany, the most central part of the mathematics syllabus at upper secondary level, teachers in our sample often mention normative aspects such as final exams which seem to have an

impact on their actual teaching of calculus. Being asked to comment on the statement “I like calculus, because many exercises can be solved by similar procedures/patterns” from a student and a teacher perspective, Mr. G2 remarked:

Mr. G2: Of course this naturally belongs to any calculus course at school level. Especially less gifted students need these rules and procedures in order to be successful in their final exams. This is the main objective for students and therefore practising these routines with exam tasks needs to be done in lessons, too. I don't think these standardised tasks are exciting but these definitions and procedures are rather like a language that needs to be learned by students.

Taking this teacher as a paradigmatic example, it becomes apparent that the instrumentalist view is at most a peripheral goal in his belief system. The comparison of mathematical concepts and procedures to a language is somehow revealing. Derivation rules, basic skills and their application to routine tasks many teachers in our sample see as prerequisite for various reasons beyond exams: as a solid foundation for a structural basis of calculus at school level, others see the tool-box aspect as a means to an end in order to enhance their students' competencies to solve optimization tasks. The actual classroom interaction makes teachers aware that the full spectrum of student ability (& success) needs to be considered. Whereas Mr. G2 takes the impact of these normative aspects for granted, other teachers articulate a negative attitude towards schema-orientation due to the determining factors of centralized exams. It is apparent though that for all teachers in our sample the preparation of the final exam does indeed play a certain role in their system of goals.

## DISCUSSION

In this report we exclusively focused on aspects of the structure teachers' beliefs systems. Since we expect differences among a teacher's belief systems referring different mathematical disciplines, our focus was on calculus at upper secondary level.

Firstly, we tried to identify how a teacher's central goals (beliefs) are correlated and, in some sense, why these goals are correlated. Based on Green's (1971) distinction of primary and derivative beliefs, we proposed the distinction of coordinated goals and subordinated (or super-ordinated) goals. In this distinction, a goal X is subordinated to another goal Y if X is a means to an end to (potentially) achieve Y. For example, an application-orientation for Mr. A is a means to an end for achieving students' motivation. Regarding a system of goals (or beliefs) as hierarchically arranged the subordinated goal of application-orientation of Mr. A is on a lower level than the goal of students' motivation. In contrast two coordinated goals, e.g. the process-orientation and the application-orientation in the case of Mr. P, are on the same level referring his hierarchically arranged system of goals concerning calculus teaching.

Further, we identified relations between goals that are insufficiently described by coordination or subordination, i.e. a contradiction between goals. For example, although goals representing the formalist view are central for Mr. G2, he does not



intend to enact these goals since he expects to impede students' learning when enacting these goals. Thus, different goals sometimes match each other, but sometimes the system of goals seems to have a quasi-logical structure and include contradicting goals representing conflicts of goals.

Finally, a possible distinction of teaching goals refers to the derivation of these goals. For example, although for a teacher like Mr. G2 goals representing the instrumentalist view are at most peripheral, these goals play a certain role in his teaching. However, enacting these goals is not primarily a means to an end for his own central goals, but for his students' central goals referring to their final exams.

We suggest two reasons for researching the relations of teachers' goals or beliefs in detail. Firstly, our results facilitate a deeper understanding of relations between goals or beliefs beyond statistical correlations. For example, in our sample the empirical independence between an application-oriented view and a formalist view (Figure 1;  $r \approx 0$ ) could be based on different relations between these views. Actually, some teachers value formalist goals high and neglect application oriented goals. However, for other teachers (like Mr. A) both formalist and application oriented goals are central although application oriented goals are subordinated to formalist goals. In turn, other teachers like Mr. G1 value formalist goals high, but do not intend to enact these goals.

Further, as illustrated by the above examples, the teachers' beliefs about teaching calculus can be seen as a multiple-layered hierarchical system of goals that each teacher tries to make sense of individually. This sense making could possibly throw some light on the relationship between teachers' espoused beliefs or goals and their enacted beliefs or goals, which is a difficult, but crucial relationship in educational research (Skott, 2009; Furinghetti & Morselli, 2011). For example, the teachers mentioned above show that e.g. an instrumentalist view is not a central part of their belief system though it seems to be a significant part of their classroom practice taking into account students' learning. This somehow confirms findings of Skott that research on beliefs and their enactment needs to consider a multiple set of factors involving the inclusion of a social perspective on belief-practice relationships (Skott, 2009, p.29). Further, the distinction of central and peripheral beliefs or goals, as well as the distinction of relations between beliefs or goals – e.g. in terms of coordination and subordination – could serve as an explanation of reported inconsistencies or consistencies between espoused and enacted beliefs or goals (Skott, 2009; Eichler, 2011).

However, the mentioned relationship between teachers' espoused and enacted beliefs as well as the relationship between a teacher's classroom practice and his students' learning still needs further research to contribute to the ongoing research on mathematics-related affect.

## References

- Eichler, A. (2011). Statistics teachers and classroom practices. In C. Batanero, G. Burril, & C. Reading (Eds.), *Teaching statistics in school mathematics-challenges for teaching and*

- teacher education: New ICMI study series* (Vol. 15, pp. 175-186). Heidelberg, New York: Springer.
- Eichler, A., & Erens, R. (2014). *Teachers' beliefs towards teaching calculus*. Manuscript submitted for publication.
- Erens, R., & Eichler, A. (2013). Belief systems' change – from preservice to trainee high school teachers on calculus. In A. M. Lindmeier & A. Heinze (Eds.), *Proc. 37<sup>th</sup> Conf. of the Int. Group for the Psychology of Mathematics Education* (Vol. 2, pp. 281-288). Kiel, Germany: PME.
- Glaser, B., & Strauss, A. (1967). *The discovery of grounded theory*. Chicago: Aldine.
- Green, T. (1971). *The activities of teaching*. New York: McGraw-Hill.
- Grigutsch, S., Raatz, U., & Törner, G. (1998). Einstellungen gegenüber Mathematik bei Mathematiklehrern. *Journal für Mathematikdidaktik*, 19(1), 3-45.
- Felbrich, A., Kaiser, G., & Schmotz, C. (2012). The cultural dimension of beliefs: in investigation of future primary teachers' epistemological beliefs concerning the nature of mathematics in 15 countries. *ZDM*, 44, 355-366.
- Franke, M. L., Kazemi, E., & Battey, D. (2007). Understanding teaching and classroom practice in mathematics. In F. K. Lester (Ed.), *Second handbook of research on mathematics teaching and learning* (pp. 225-256). Charlotte, NC: IAP.
- Furinghetti, F., Morselli, F. (2011). Beliefs and beyond: Hows and whys in the teaching of proof. *ZDM*, 43, 587-599.
- Hannula, M. S. (2012). Exploring new dimensions of mathematics-related affect: embodied and social theories. *Research in Mathematics Education*, 14(2), 137-161.
- Heckhausen, H., & Gollwitzer, P. M. (1987). Thought contents and cognitive functioning in motivational versus volitional states of mind. *Motivation and Emotion*, 11(2), 101-120.
- Leatham, K. (2006). Viewing mathematics teachers' belief systems as sensible systems. *Journal of Mathematics Teacher Education*, 9, 91-102.
- Mayring, P. (2010). *Qualitative Inhaltsanalyse: Grundlagen und Techniken*. Weinheim, DE: Beltz.
- Pajares, F. (2007). Teachers' beliefs and educational research: Cleaning up a messy construct. *Review of Educational Research*, 62(3), 307-332.
- Philipp, R. A. (2007). Mathematics teachers' beliefs and affect. In F. K. Lester (Ed.), *Second handbook of research on mathematics teaching and learning* (pp. 257-315). Charlotte, NC: Information Age Publishing.
- Schoenfeld, A. H. (2011). *How we think. A theory of goal-oriented decision making and its educational applications*. New York: Routledge.
- Skott, J. (2009). Contextualising the notion of 'belief enactment'. *Journal of Mathematics Teacher Education*, 12, 27-46.
- Stein, M. K., Remillard, J., & Smith, M. S. (2007). How curriculum influences student learning. In F. K. Lester (Ed.), *Second handbook of research on mathematics teaching and learning* (pp. 319-369). Charlotte, NC: Information Age Publishing.

# DO SUBJECT SPECIALISTS PRODUCE MORE USEFUL FEEDBACK THAN NON-SPECIALISTS WHEN OBSERVING MATHEMATICS LESSONS?

Sheila Evans<sup>1</sup>, Ian Jones<sup>2</sup>, Clare Dawson<sup>1</sup>

<sup>1</sup>University of Nottingham, <sup>2</sup>Loughborough University

*Schools, districts and inspectorates routinely use non-specialists to observe lessons for accountability and professional development purposes. However, there is little empirical research on how well non-specialists observe lessons. We describe two pilot studies in which education professionals made judgements about mathematics lesson observation reports, written by both specialists and non-specialists. In terms of providing feedback to the observed teachers, the professionals considered the specialists' reports to be significantly more useful than the non-specialists' reports. Written advice about a teacher's practice influenced these judgements. The paper considers theoretical and practical implications, as well as limitations of our findings.*

Lesson observations are common practice around the world for the evaluation and professional development of school teachers (Lewis, Perry, & Murata, 2006; Ofsted, 2012). They provide an opportunity to improve practice and can influence a teacher's career or a school's status. Many of these observations are conducted by teachers who are not specialists in the subject being taught (Wragg, Wilkley, Wragg & Haynes, 2002). The research reported in this article was prompted by an intuitive assumption that subject specialists are better positioned than non-specialists to give feedback on observed lessons, along with a paucity of research as to whether this assumption is warranted.

One notable study that did touch upon the role of subject specialism when observing lessons was conducted by Wragg *et al.* (2002). Using questionnaires and case studies, the researchers found that teachers often judge observation feedback most helpful to improving practice when the lesson observation was conducted by a subject specialist. Where the observer was not a subject specialist feedback was "bereft of ideas [on how to improve the lesson]" (p. 200) and could be "bland [when the observer] did not have first-hand experience of the subject" (p. 203).

A later study by Peake (2006) provided further support to the importance of subject expertise. Peake, using questionnaire- and survey-based methods, found that teachers working in post-compulsory education considered subject-specialist observers to offer substantially more helpful feedback than non-specialists. Moreover, some teachers were inclined not to take feedback seriously from non-specialist observers.

We have encountered no studies beyond Wragg and Peake in which the subject specialism of the observer is a concern. Instead the research focus is typically on student learning gains (Strong, Gargani & Hacifazlioglu, 2011) and the development

of lesson observation protocols, methods and skills for research purposes (Douglas, 2009). Nevertheless, a theme within this literature is that professional knowledge and experience appears to impact on what is noticed and prioritised when observing lessons (Grant, Hiebert & Wearne, 1998). Furthermore, the literature is clear that what teachers perceive as useful in an observation report depends on their expertise (Carter, Cushing, Sabers, Stein & Berliner, 1988; Colestock & Sherin, 2009; Santagata, Zannoni & Stigler, 2007; Star & Strickland, 2008). For instance, a novice teacher may find advice on classroom management more useful than the subtleties of dealing with unanticipated misconceptions. Conversely, it is these very subtleties that concern expert teachers.

To our knowledge there are no studies that directly test the qualitative hypotheses drawn-up by Wragg and Peak. We conducted two studies to help address this gap. We first investigated whether subject specialists produce written lesson observation reports that (i) are distinguishable from those of non-specialists, and (ii) are more “useful” in terms of helping a teacher improve her teaching compared to those of non-specialists. Integral to this study is the exploration of participants’ understanding of “useful feedback”.

## **OBSERVED LESSONS**

Two experienced mathematics teachers taught four lessons in a UK secondary school. One teacher taught two lessons with a class of 12 and 13 year olds and the other with a class of 15 and 16 year olds. Two teachers, one specialist (mathematics) and one non-specialist (English language) observed each lesson. In total, four observers observed two lessons each. Each observer completed an unstructured report framed by questions based on typical observation forms: *What is your overall impression of the lesson? What is the lesson about? How did student learning take place? How could the lesson be improved?* The completed reports were anonymised and the subject specialism of the observer was not indicated on the reports.

In common with the majority of routine observations, all observers were known to the teachers; they were colleagues. It was assumed that the specialists knew more about, and shared more of each teacher's beliefs, style of teaching, issues and goals.

In a traditional lesson, students often work on an exercise using the same method. Student misconceptions, difficulties and errors are predictable. In contrast, the lessons in this study were based around non-routine, unstructured tasks. These lessons can proceed in unexpected ways; students can use unanticipated solution-methods and unforeseen difficulties including misconceptions may arise. We predicted that compared to a more traditional lesson, these lessons would provide greater opportunities for observers to suggest feedback to help improve teacher practice. For instance, advice on how to help students make connections between various solution-methods. This in turn, may draw out the differences between reports written by the specialist and non-specialist observers.

In accordance with the literature, we expected all observers would provide general pedagogical advice, but only subject specialists would provide advice that draws on their pedagogic content knowledge and their subject knowledge (Shulman, 1986). For instance, all observers may provide advice on student engagement, but only the specialist observer would provide advice on how to orchestrate a whole class discussion in order to build on the collective sense-making of the students.

## STUDY 1

The purpose of Study 1 was to establish whether the lesson observation reports produced by specialists were distinguishable from those produced by non-specialists. Twelve professionals, namely teachers (6), teacher educators (4) and researchers with teaching experience (2) drawn from a range of specialisms (art, general education, geography, German, history, mathematics) participated in Study 1.

The observation reports were divided into four sets of four reports such that no set contained more than one report written by a given observer. Each participant received one set of reports. The task of the participants was to decide whether a mathematics or English language specialist had written each report. Participants could also write a comment about each decision. In total each report was independently categorised six times.

Nine of the twelve participants correctly categorised all four of their allocated reports as having been written by specialists or non-specialists. A further two participants correctly categorised just two reports. The remaining participant incorrectly categorised all four reports.

To test whether the twelve participants as a whole categorised the eight reports at a level above chance we conducted a Mann-Whitney U test, comparing our group of participants with a hypothetical group of twelve participants performing at chance. The result demonstrated that the participants were indeed able to correctly categorise the reports at above chance level ( $z = -3.20, p < .01$ ).

The comments provided by the participants revealed that the most common basis for deciding whether to categorise a report as produced by a specialist or not was the degree and sophistication of mathematical content. For example, one participant correctly categorised a specialist observation and wrote, "The type of observer is given away at the end by the statement ' $\sin x = 0.5$  has infinite solutions but is not always true'. Would an English language specialist be able to comment like this?" Conversely, another participant correctly categorised a non-specialist report because of its lack of mathematical content.

## STUDY 2

The purpose of this second study was to establish whether specialists' observation reports were perceived as more useful in terms of helping the observed teachers improve their practice, than those of the non-specialists. Subsequently, their

understanding of “useful feedback” was explored. It was likely that teachers would know the authors of the reports. This knowledge could influence their judgments. For instance if they knew the Head of Mathematics wrote a report then they may assume the report was useful. Evaluation therefore might depend more on who has written the report rather than whether or not it was a worthy one. So, instead of asking the teachers to judge the reports, eight mathematics education professionals, namely teacher educators (2), researchers with teaching experience (6) participated. None had participated in Study 1. These participants did not know the teachers; they did not know whether they were novices or experts. Their judgments were based on the reports alone; not whether the advice matched the expertise of the teacher.

A comparative judgement method (Thurstone, 1927) was used to rank the lesson observation reports in terms of perceived usefulness as feedback to the observed teachers. The outcome of the pairwise judgements can then be used to construct a psychological scale of artefacts from “best” to “worst” (Bramley, 2007).

Each participant was presented with eight pairs of reports and asked to decide, for each pair, which report they thought provided the most useful feedback to the observed teacher. In total, every possible pairing of observation reports was judged twice, each time by a different participant, resulting in 56 pairwise judgements. Once the judgments were complete, participants were asked to comment on their decisions.

We independently coded each report; categorising “suggestions for improvement” as being based on either (i) general pedagogic knowledge, (ii) pedagogic subject knowledge or (iii) subject knowledge. To gain further insight into the types of advice prioritised by observers we drew on Wake’s (2011) work on knowledge for teaching and learning. We subdivided the pedagogic subject knowledge and subject knowledge into six categories of subject knowledge for teaching (Ball, Thames and Phelps 2008). This may clarify what is valued in an observation report.

## ANALYSIS AND RESULTS

The participants’ pairwise judgments were statistically modelled (Bramley, 2007) to produce a parameter estimate and standard error for each report. These parameters enabled the construction of a scaled rank order of reports from “best” to “worst”, as shown in Figure 1. The top four reports were those by the specialist observers (labelled “S”). The internal consistency (Rasch Separation Reliability (Bramley, 2007)) for the scaled rank order was .65, an acceptably high reliability for discriminating between two groups (specialist and non-specialist).

To investigate these groupings further, we categorised each lesson observation report as either in the top half (assigned a value of 1) or the bottom half (assigned a value of 0) of the rank order. Fisher’s exact test using “specialism” and “top or bottom” as categorical variables reached significance ( $p = .029$ , two tailed), supporting interpreting the result as two distinct groups of four reports. Study 2 therefore provided support that the participants perceived the specialists’ reports to be more useful in terms of feedback to the observed teachers than the non-specialists’ reports.

## Participant feedback

All eight participants cited a preference for reports that made concrete suggestions for improvement. However, beyond this there was no clear consensus as to what constituted a more “useful” report. For example, some cited a preference for reports that described the lesson in detail whereas others had a preference for reports that avoided detailed description. Surprisingly, only two participants explicitly cited mathematical content as influencing their judgement decisions.

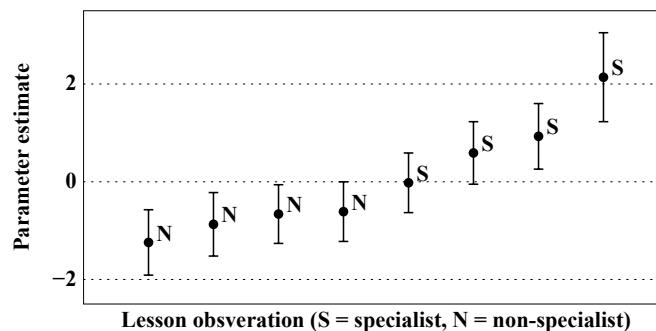

Figure 1: Scaled rank order of the lesson observation reports.

## Coding observation reports

Overall, there was consistency between the authors’ coding. The specialists offered a total of 22 suggestions for improvement, ten of which drew on subject knowledge, the non-specialists offered a total of five suggestions, all drawing on general pedagogical knowledge. Table 1 shows the ten math-based suggestions categorized, using a summarised version of Ball, Thames and Phelps’ (2008) categories of subject knowledge for teaching.

Category	Description	Suggestions
Specialised Knowledge SCK	Content Mathematical knowledge unique to teaching	2 explicit 3 implicit
Common Knowledge CCK	Content Mathematical knowledge and skills, not unique to teaching	1 explicit 2 implicit
Horizon Knowledge HCK	Content Understanding how to develop and build on students current knowledge	0 explicit 0 implicit
Content of Knowledge and Students CKS	Understanding how groups of students talk about and handle specific tasks	4 explicit 1 implicit
Content of Knowledge and Teaching CKT	Understanding the design of teaching tasks/sequences of instruction	2 explicit 1 implicit
Content of Knowledge and Curriculum CKC	Understanding how the lesson relates to the curriculum and assessments	1 explicit 0 implicit

Table 1: Categorized numbers of “suggestions for improvement” in the reports.

The authors noted some reports contained additional observer comments, that although not explicitly advice, could be construed as potentially helpful to teachers, especially if they intended to re-use the lesson. For example, an SCK comment: “pairs did not get to grips with Tanya’s method. No one spotted that her lines were drawn wrongly, or that she was wrong to assume that one particular vertex was optimal”.

Although observers did not teach the students Mathematics, there were five instances of the use of the CKS domain. On these occasions subject specialists noticed, in the moment of observing, and subsequently reported on, how students were talking about the mathematics and handling the challenges of the task. For example, one observer stated “The questions: What assumptions did they make? Were they valid? Was their mathematics correct? seemed a bit hard even for this bright group”. Only one observer suggestion was based on how the lesson relates to the CKC domain. Considering the lessons were non-standard and the pressure for students to achieve in high-stake, content driven tests, this is surprising.

## **GENERAL DISCUSSION**

The participants in Study 1 correctly distinguished lesson observation reports written by specialist teachers from those written by non-specialist teachers. The presence or absence of mathematical content appeared to be the key discriminator between the reports. The participants in Study 2 perceived that lesson observation reports written by specialists were more useful in terms of helping teachers improve their practice than those written by non-specialists. These judgements were not based on the presence or absence of mathematical content, but the presence of suggestions for improvement. The authors’ coding of the reports corroborated this. Specialists offered substantially more suggestions than the non-specialists. However, although participants tended not to explicitly refer to the mathematical content of these suggestions, nearly half the specialist suggestions drew on subject knowledge, whereas non-specialists provided no mathematics-based advice. Surprisingly, nearly half these mathematics-based suggestions were based on the CKS domain. We conjecture that the teachers are drawing on their own knowledge of students when noticing and evaluating how students are progressing with a task.

### **Limitations**

The materials were drawn from just four observers, four non-standard lessons and two mathematics teachers, all from one school. Caution must therefore be exercised as to the generalisability to other teachers, lessons, schools and subject areas. The finding from Study 2 generalises only to the study participants. That is, we expect that the same group of participants would perceive specialist reports to be more “useful” than non-specialist reports in general. However, we cannot generalise beyond this group of participants to expect that all mathematics education professionals would perceive observation reports similarly. Results may be quite different if, for example the observed teachers were all novices or the lessons were of a more traditional structure and content.

### **Theoretical implications**

What is it about a specialist teacher’s lesson observation report that mathematics professionals perceive to be more useful than a report of a non-specialist? Study 1 suggests that a key discernible difference is the presence of mathematical content.



However mathematical content was not cited at all by six of the eight mathematics professionals in Study 2, who nevertheless preferred the specialists' reports. One possible explanation is simply that subject specialists are better at providing useful feedback. Participants may respond more positively to reports by members of the same community, mathematics education, as they are likely to share similar beliefs, values and goals. Furthermore, the study showed that their reports did indeed provide more pedagogical advice whether of a general or specialist nature. If this is the case then we should expect the result of Study 2 to generalise to other subject disciplines. For example, we would expect history teachers to produce history lesson observation reports perceived as more useful than those produced by teachers of other subjects.

Another possible explanation is that mathematics teachers are simply better at producing useful feedback than language teachers per se, rather than just for the case of lessons in their own discipline. Although this is a provocative hypothesis, studying mathematics is widely regarded to increase general analytic skills (e.g. Smith, 2004), which might include lesson observation skills. If mathematics teachers are indeed generally better at observing any lesson than non-mathematicians then the finding from Study 2 would not be expected to generalise to other subject specialisms. For example, if the study were reversed so that mathematics and language teachers observed language lessons, then we would not expect the subject specialists' reports (language teachers in this case) to be perceived as more useful than the non-specialists' reports.

Conversely, the paucity of advice offered by non-specialists may be explained by the widely held belief that mathematics is a 'difficult' subject. Non-specialists may lack the confidence to offer advice to mathematics teachers. If this is the case, then only when observing mathematics lessons, and perhaps other technically demanding subjects, would it be perceived that specialists offer more useful advice than non-subject specialists.

We are currently undertaking further research to address the above limitations, and to discern between these possible explanations.

### **Practical implications**

If it is the case that mathematics teachers are "better" at observing mathematics lessons than non-specialists, or that non-specialists do not feel equipped to offer advice, then the practical implications are self-evident. Lesson observations are commonly used for professional development and accountability purposes, and it is vital that they are of high quality. However it is standard practice in many countries for high-stakes observations of mathematics lessons to be conducted by non-specialists. The findings reported here contribute some evidence that schools, districts and inspectorates might be advised to ensure that lesson observations, when intended to help mathematics teachers develop their practice, involve mathematics subject specialists whenever possible.

## References

- Ball, D. L., Thames, M. H., & Phelps, G. (2008). Content knowledge for teaching: What makes it special? *Journal of Teacher Education*, 59(5), 389-407.
- Bramley, T. (2007). Paired comparison methods. In P. Newton, J.-A. Baird, H. Goldstein, H. Patrick, & P. Tymms (Eds.), *Techniques for monitoring the comparability of examination standards* (pp. 264-294). London: QCA.
- Carter, K., Cushing, K., Sabers, D., Stein, P., & Berliner, D. (1988). Professional-novice differences in perceiving and processing visual classroom information. *Journal of Teacher Education*, 39, 25-31.
- Colestock, A., & Sherin, M. (2009). Teachers' sense-making strategies while watching video of mathematics instruction. *Journal of Technology and Teacher Education*, 17, 7-29.
- Douglas, K. (2009). Sharpening our focus in measuring classroom instruction. *Educational Researcher*, 38, 518-521.
- Grant, T. J., Hiebert, J., & Wearne, D. (1998). Observing and teaching reform-minded lessons: What do teachers see? *Journal of Mathematics Teacher Education*, 1, 217-236.
- Lewis, C., Perry, R., & Murata, A. (2006). How should research contribute to instructional improvement? The case of lesson study. *Educational Researcher*, 35, 3-14.
- Ofsted. (2012). *School inspection handbook: Handbook for inspecting schools in England under section 5 of the Education Act 2005*. London: Office for Standards in Education.
- Peake, G. (2006). *Observation of the practice of teaching*. Huddersfield, UK: PCET Consortium, University of Huddersfield.
- Santagata, R., Zannoni, C., & Stigler, J. W. (2007). The role of lesson analysis in pre-service teacher education: An empirical investigation of teacher learning from a virtual video-based field experience. *Journal of Mathematics Teacher Education*, 10, 123-140.
- Shulman, L. S. (1986). Those who understand: Knowledge growth in teaching. *Educational Researcher*, 15(2), 4-14.
- Smith, A. (2004). *Making mathematics count*. London: The Stationary Office.
- Star, J. R., & Strickland, S. K. (2008). Learning to observe: using video to improve preservice mathematics teachers' ability to notice. *Journal of Mathematics Teacher Education*, 11, 107-125.
- Strong, M., Gargani, J., & Hacifazlioglu, Ö. (2011). Do we know a successful teacher when we see one? Experiments in the identification of effective teachers. *Journal of Teacher Education*, 62, 367-382.
- Thurstone, L. L. (1927). A law of comparative judgment. *Psychological Review*, 34, 273-286.
- Wake, G.D. (2011). Teachers' professional learning: Modelling at the boundaries. In G. Kaiser, W. Blum, R. Borromeo Ferri, & G. Stillman (Eds.), *Trends in teaching and learning of mathematical modelling* (pp. 653-662). The Netherlands: Springer.
- Wragg, E. C., Wilkley, F., Wragg, C. M., & Haynes, G. S. (2002). *Teacher appraisal observed*. London: Routledge.

# EXPLORING MATHEMATICS TOGETHER: FIGURING THE WORLDS OF TEACHERS AND PROSPECTIVE TEACHERS

Bryan Fede<sup>1</sup>, Marta Civil<sup>1</sup>, Rocío Toscano<sup>2</sup>

<sup>1</sup>The University of North Carolina at Chapel Hill, USA

<sup>2</sup>Universidad de Sevilla, Spain

*This paper reports on an intentionally constructed hybrid space, the Odyssey, as an approach to address the gap between theory and practice in teacher education programs. In the Odyssey, prospective teachers and mentor teachers engaged in joint explorations of mathematics. We analyzed the interactions among participants using the concepts of figured worlds and positional identities (Holland, Lachicotte, Skinner, & Cain, 1998). Findings point to the potential of experiences such as the Odyssey to challenge the power differential that often exists between mentor and prospective teachers. Furthermore the act of engaging in mathematical activities together may encourage prospective teachers to elaborate on their mathematical explanations as well as allow mentor teachers the opportunity to (re)visit mathematical ideas.*

## INTRODUCTION

Teacher preparation approaches often include university courses and field experiences in nearby schools, but the connections between these two settings are not always made explicit. As a result, a rift is sometimes created that juxtaposes the theoretical aspects of teaching learned in university classes and the reality that prospective teachers (PTs) experience in their school placements. PTs are often left on their own to mediate potentially conflicting messages that they get from university faculty and the mentor teachers (MTs) in the local schools.

The study presented here is part of a larger project that was designed to bridge these different settings (university courses and field experiences) through several joint activities. These included MTs visiting the methods courses, PTs working in the MTs' classrooms, MTs and PTs jointly interviewing children on mathematical thinking, and the Odyssey, a summer institute where PTs and MTs engaged in the practices of mathematics and science. Many of these common experiences are likely to reflect an expert-novice differential, particularly in terms of pedagogy, where the MTs are the experts and the PTs the novices. The Odyssey, however, with its focus on participants doing mathematics and science, offers a very different kind of experience, one in which the expert-novice differential is not based on an MT-PT distinction. Hence, in this study we explore the potential of environments such as the Odyssey to make connections between field experiences (practical) and university courses (theoretical) through a learning experience that is more egalitarian in nature.

## **THEORETICAL FRAMEWORK**

The design of the overall project is grounded on a third-space framework (Moje, Collazo, Carrillo, & Marx, 2001) where prospective teachers, mentor teachers, university faculty and content specialists work together in common spaces to discuss issues of content and pedagogy. The third-space framework in this work attempts to define new, hybrid spaces where various perspectives on teaching converge to create new understandings on the part of all of the participants about what it means to teach. Operating in the third space serves to bring academic and practitioner knowledge together in ways that are less influenced by traditional power relationships that divide these discourses. This in turn opens up new learning opportunities for prospective teachers (Zeichner, 2010). In order to interpret the social interactions displayed in these hybrid spaces, we have turned to Holland's idea of figured worlds (Holland, et al., 1998) to describe within group interactions.

### **Figured Worlds, Local Spaces of Practice, and Positional Identities**

A figured world is “a socially and culturally constructed realm of interpretation in which particular characters and actors are recognized, significance is assigned to certain acts, and particular outcomes are valued over others” (Holland et. al., 1998, p. 52). They are “as-if” or virtual realms in which persons become indoctrinated to the norms of the figured world through continual participation with other actors within the realm. Figured worlds are continuously defined and redefined by the everyday actions that occur within them. While one might describe typical behaviors within these worlds, it is important to recognize the behavioral variations that can occur. It is also important to know that multiple figured worlds are often present, though not necessarily all at the same time.

Given that multiple figured worlds are often present at any given time, it is critical to investigate the way they interact. Holland and Lave (2000) refer to the social context of this interaction as the local space of practice. This space is socially and historically situated, a real-world setting that exists in a particular place and time. As such, this local space of practice at least partially determines the presence and magnitude of particular figured worlds within a space. In the study presented here, the Odyssey was the local space of practice.

Since individuals may, and often do enact multiple figured worlds within a local space of practice, there exists the likelihood that these figured worlds may come into conflict given a particular setting. In the case of the Odyssey, a number of figured worlds came into play. The university faculty asked PTs and MTs to engage in Odyssey activities as “doers of mathematics”, hence invoking the figured world of the discipline of mathematics. Throughout the Odyssey, PTs and MTs also enacted the figured worlds of the elementary school classroom as well as that of university courses.

In each of the different figured worlds that are present, there exist interpersonal power relationships that affect one's participation in the local space of practice. Holland et al. (1998) refer to these differences in position relative to other group members as

positional identities. Positional identities have to do with “the day-to-day and on-the-ground relations of power deference and entitlement, social affliction and distance – with the social interactional, social-relational structures of the lived world” (p. 127). In essence, positional identity refers to the awareness of a person’s social position within a figured world. The local space of practice combined with the prominence of the various figured worlds evident within, allow for participants to take up and assert different positional identities.

In mathematics education, positionality has been looked at as a way of interpreting power relationships between students in the classroom. Esmonde and Langer-Osuna (2013) investigate differences in engagement in mathematical activities as students are given the opportunity to take up different positions within a local space of practice that contains multiple figured worlds. In the *Odyssey*, we have extended this investigation to interactions between PTs and MTs within the context of a teacher education program. As the participants navigate the various figured worlds present, they often modify the way they position themselves as they negotiate what it means to practice mathematics within these figured worlds. In what follows we look at these shifts in position as opportunities for participants to make connections between the theoretical and the practical aspects of teaching mathematics.

## **METHOD**

In the mathematics portion of the *Odyssey* (which is the focus of this study), participants were encouraged to think mathematically about the problems presented in the seminar as “doers of mathematics” rather than thinking about teaching considerations such as the way that children might take up these tasks. The problems focused on pattern exploration and on generating and justifying general rules (one set of problems led to  $n(n-1)/2$  and the other to  $2^n$ ). Data for this study consist of video recordings of four groups of PTs and MTs as they worked on the different problems. There were more MTs than PTs at the *Odyssey*, but each of the four groups of four in our study had at least one PT. One camera was placed at one end of the table and a flat microphone was placed in the center of the table to record as much of the interaction as possible. In addition to the video recordings, participants’ notebooks were collected. Researcher field notes were also referred to at times to clarify the context of the interactions when needed. Using Powell, Francisco and Maher’s (2003) model for video analysis, we identified critical events relating to our research goal. The research team watched the videos specifically looking for instances where we noticed changes in either how group members were being positioned, or how they were positioning themselves. These critical events became clips and were transcribed. The transcriptions are the data for the analysis. A first pass through the data led to two codes related to the form of engagement with the task: doers of mathematics and teachers. Codes for this study were developed around the idea of Holland et al. (1998) of positional identities.

Within these broadly defined categories of doers of mathematics and teachers, several positions emerged in our analysis. Within the category of doers of mathematics, we identified: 1) *mathematical expert*: when a participant defers to another for a mathematical explanation or for help with a problem; (2) *sense maker*: engages in the activity in ways that go beyond simply obtaining an answer. The sense maker is not only hoping to accomplish the task, but also gain insight and understanding of underlying processes; 3) *rule oriented*: engages in the task in a formulaic or procedural nature. The rule oriented focuses on coming up with the general expression but is less concerned with explanations and understandings; 4) *resistor*: pushes the other members of the group to revisit or make sense of the work they are doing, hence resisting the status quo and often instigating a new direction in the exploration of the problem.

Similarly, within the category of teacher, we identified three different positions: 1) *pedagogical expert*: most often enacted by a MT in interaction with a PT. In these interactions MTs draw upon their classroom experience and share their pedagogical knowledge with the PT(s); 2) *professional colleague*: most often enacted between multiple MTs (but could involve PTs). Participants make observations and connections related to elementary school teaching practices; 3) *teacher-to-be*: a position taken up by PTs in interactions with MTs around possible connections between the task at hand and the elementary classroom (e.g., around manipulative materials).

## RESULTS

This study sought to explore the potential of spaces such as the Odyssey to address the disconnect that often exists between university-based and field-based experiences in teacher preparation. We first give an overview of the main findings and then illustrate some of them in more detail. Throughout the Odyssey, MTs and PTs engaged in the problems as colleagues thereby invoking a symbiotic relationship. For MTs the Odyssey allowed them to explore and learn content as learners of mathematics, an opportunity that is often more difficult to achieve in the figured world of classroom teaching. In this context, MTs seemed to turn to PTs as mathematical experts, arguing that PTs had had more recent experiences with mathematics through their university courses. PTs were actively engaged in the mathematical tasks, often starting in a *rule oriented* position but switching to *sense makers* in the course of their interaction with group members. MTs as *resistors* seemed to facilitate this switch. PTs were pushed to explain the “whys” of the mathematics behind the formulas to assist MTs in making sense of the group’s work. Hence, PTs seem to have gained valuable experience as mathematical explainers.

Through this symbiotic relationship, we argue that participants are afforded various opportunities to navigate through different figured worlds. Figure 1 (below) shows the potential path that participants might take through an Odyssey interaction. We focus on three figured worlds: the elementary school classroom, the university courses, and the discipline of mathematics. Participants may travel along a meandering path in and out

of the various intersections of figured worlds. They may also travel outside these three figured worlds altogether into any one of a number of figured worlds that are less immediately present all the while attempting to make sense of what it means to understand mathematics.

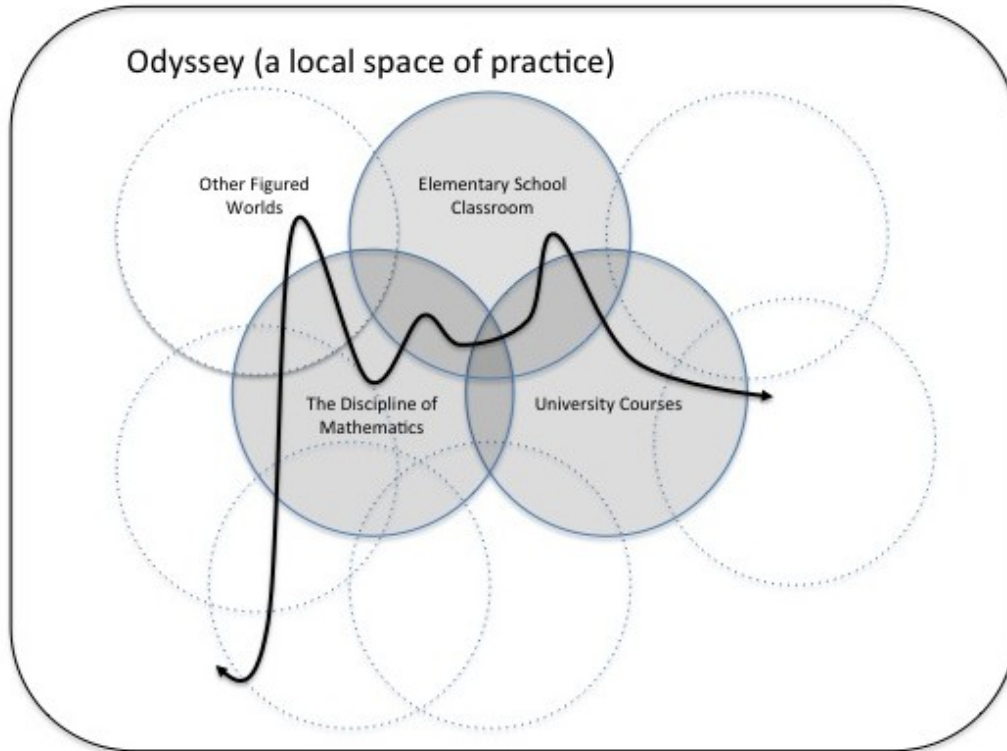

Figure 1: Potential trajectory of participant positioning through various figured worlds in the Odyssey.

### PTs as Mathematical Experts

One of the problems involved making trains with colored rods of different lengths and finding all possible combinations for a given length (e.g., if the length is 3, there would be 4 possible trains: 3; 2+1; 1+2; 1+1+1). Odette (MT), in talking to one of the university facilitators, says:

One of these guys [pointing to the 2 PTs in her group] had the **bright idea** to start with one white and see how many we can make... And then we started thinking, “is there any that we kind of missed?” And we filled in a couple that we had missed. But these guys [gestures to the PTs] are trying to **figure it out mathematically with combinations**. So, they might have some input for you.

Odette is positioning the PTs as *mathematical experts* in that they are the ones who may be coming up with the general statement. Indeed, the PTs tended to want to come up with formulas right away, often in what university faculty labeled as a procedural approach, hence positioning them as *rule oriented*. However, the interactions with MTs could serve as catalysts for switching to *sense maker*, as we illustrate next.

### **From Rule Oriented to Sense Maker**

In the handshakes problem (how many handshakes are possible in a room full of people assuming that each person shakes hands with all of the other people in the room), Beatrice (PT) has come up with an expression to find the number of handshakes as being  $(n-1) + (n-2) + (n-3) \dots$ , where  $n$  is the number of people in the room. Tonya (MT) does not understand why for 3 people it is 3 handshakes (she thinks it is 6):

Tonya: I don't get that. Three people, three handshakes.

Beatrice: Yeah.

Tonya: No.

Beatrice: Yeah.

Odette (MT): Yeah. Just draw it out.

Beatrice: Because 3 minus 1 is two, plus 3 minus 2 is one... two plus one is three.

Beatrice's answer does not address Tonya's question. Instead Beatrice shows Tonya how using her formula gives an answer of 3 and that seems to be her evidence for why it is 3. Odette's comment of "just draw it out" is not picked up by Beatrice or Tonya. Shortly after, Celine (MT) draws it out and shows Tonya why it is 3. As they move to 4 people, Beatrice is still focused on her algebraic expression, while Odette and Celine are talking through the process to try to come up with a general expression. But then all of a sudden Beatrice turns to Tonya (who has been gesturing handshakes to try to visualize the case for 4 people) and says:

If you draw it like this (pointing to a drawing Beatrice has made in her notebook), it's like there... they shake, and then... they'll shake and then these last two shake. And then you just count one, two, three, four, five, six.

In this interaction with Tonya, Beatrice switches from a focus on using her formula to a sense making approach similar to Odette's and Celine's in making a drawing and showing Tonya why there are six handshakes with four people. This points to the potential of interactions such as these to connect the PTs' knowledge of mathematics with the MTs' pedagogical knowledge. The MTs bring to these mathematical tasks their experiences as teachers asking students to explain their work as well as more exposure through their years of professional development to conceptual approaches to teaching mathematics. Hence, they may be drawing on these backgrounds to push for a sense-making approach to doing mathematics.

### **Engaging as a Teacher**

Although the university facilitators viewed the Odyssey as an opportunity to engage as doers of mathematics, some MTs engaged primarily as teachers. Zelda (MT) is one such case. Throughout the investigation of the trains' problem, Zelda contributes minimally to the group's mathematical work. She keeps track in her notebook of the different combinations that the group is mentioning, and on a few occasions interjects combinations that they may have missed. But she does not engage in the group efforts



on trying to find a pattern and eventually a general expression. Most of Zelda's comments relate to connections to her experience as a classroom teacher (e.g., in terms of the kinds of affordances that different manipulative materials may offer). Zelda's positionings were mostly as *pedagogical expert* or as *professional colleague*. For example, in the excerpt below Zelda, as *pedagogical expert*, connects the trains' problem to an early grades activity where children are to find different ways to make up a number, and proceeds to explain this to Norma (PT):

[Looking at Norma and gesturing as if she had interlocking cubes] They [children] will take the numbers apart, it's like when they say "the number is 12, how many different ways can you make 12?"; it's the same idea, you give them interlocking blocks and they are always breaking them apart [gesturing as if she had the interlocking cubes in her hands].

The positioning of one member of the group as a *pedagogical expert* in the context of a mathematical activity provides a potentially fruitful space in which we might bridge theory and practice. In some cases, the mathematical task provided an opportunity for MTs to share their pedagogical experience, as well as for PTs to bring up questions about classroom applications.

## CONCLUSION

In teacher preparation efforts, experiences that bring PTs and MTs together often center on pedagogy and therefore are likely to reflect a power differential, where MTs are seen as the experts. The Odyssey was unique in that it purposefully constructed a local space of practice in an off-site setting that was neither the domain of the PT (the methods classroom) or the MT (elementary classroom). This space brought PTs and MTs to do mathematics together and in so doing acknowledged different kinds of knowledge. In the Odyssey context, MTs often displayed vulnerability with regards to their content knowledge that might not be evident in other settings. Through this vulnerability and their call for explanations, MTs seemed to encourage the PTs to reposition themselves in the group as *sense makers*. Within this space of practice, MTs could investigate mathematical challenges that they might not have seen in some time, while at the same time, PTs gained an awareness of the need to make sense of the mathematics and gained pedagogical insights through observing how the MTs interacted. The following participants' reflections capture the egalitarian potential of spaces such as the Odyssey.

It was fun to work together on math and bring our experience / expertises together. It didn't matter what we knew, but we all worked together. It was also nice to get to know all the mentor teachers.... Math really focused on everyone and was extremely beneficial. [Olivia (PT)]

I enjoyed meeting the PTs in a more informal setting; it seemed we were able to bond more, share ideas, be on more equal. [Zelda (MT)]

Comfortable learning together. [PTs] see us as "learners" also, not just teachers. [Tonya (MT)]

## **Acknowledgements**

This material is based upon work supported by the National Science Foundation under grant No. DRL-1019860. We would like to thank our project colleagues Marcy Wood and Jennifer Kinser-Traut for their help in refining our codebook. An additional thanks to Tim Conder for his assistance with our understanding of the Figured Worlds framework.

## **References**

- Esmonde, I., & Langer-Osuna, J. M. (2013). Power in numbers: Student participation in mathematical discussions in heterogeneous spaces. *Journal for Research in Mathematics Education*, 44(1), 288-315.
- Holland, D., Lachicotte, W. Jr., Skinner, D., & Cain, C. (1998). *Identity and agency in cultural worlds*. Cambridge, MA: Harvard University Press.
- Holland, D., & Lave, J. (Eds.). (2000). *History in person: Enduring struggles, contentious practice, intimate identities*. Santa Fe, NM: School of American Research Press.
- Moje, E. B., Collazo, T., Carrillo, R., & Marx, R. W. (2001). “Maestro, what is ‘quality’?” Language, literacy, and discourse in project-based science. *Journal of Research in Science Teaching*, 38(4), 469-498.
- Powell, A. B., Francisco, J. M., & Maher, C. A. (2003). An analytical model for studying the development of learners’ mathematical ideas and reasoning using videotape data. *The Journal of Mathematical Behavior*, 22(4), 405-435.
- Zeichner, K. (2010). Rethinking the connections between campus courses and field experiences in college-and university-based teacher education. *Journal of Teacher Education*, 61(1-2), 89-99.

# **ALGEBRAIC EXPRESSIONS OF DEAF STUDENTS: CONNECTING VISUO-GESTURAL AND DYNAMIC DIGITAL REPRESENTATIONS**

Solange Hassan Ahmad Ali Fernandes, Lulu Healy

Anhanguera University of São Paulo

*This paper explores the algebraic expressions of deaf learners as they explore and construct sequences using the digital microworld Mathsticks. More specifically, it attempts to identify how the deaf students coordinated bodily, discursive and digital resources in order to attribute their own personal senses to the notion of variable. Examples of their interactions with the tasks and tools are analysed to identify evidence of the presence of the three conditions of algebraic thinking, indeterminacy, denotation and analyticity. Our findings suggest that the creation of a shared sign “secret number” to represent the idea of variable was central in facilitating the students to adopt algebraic rather than arithmetic approaches and to appropriate the idea of a general term.*

## **DISCURSIVE MODES, LEARNING AND ALGEBRAIC THINKING**

Our research with students with disabilities focuses on how the specific ways in which they experience and interact with the world mediate their learning. In the case of deaf learners, for example, we are interested in better understanding how the visuo-gestural expressions of signed languages, as well as the interactional practices associated with their use, shape the appropriation of mathematical knowledge. In this paper, we concentrate on the participation of Brazilian deaf students, whose first language is Libras (Brazilian Sign Language), in activities involving the construction of algebraic generalisations to represent the mathematical structure of visually presented sequences.

Our approach has been strongly influenced by the work of Vygotsky and especially by his ideas concerning the mediating role of material and semiotic tools, which emerged initially from his studies with people with disabilities (Vygotsky, 1997). For Vygotsky, language is a broad concept which encompasses, as well as the communicative function, the function of organising and developing the processes associated with thinking. In the case of the deaf learner, his view was that in order to overcome the barriers related to the absence of an oral language, from a very early age the deaf child develops “habits of mimic-gestures” that represent more than a way of expressing their emotions, becoming also a vital mode of discursive communication (Vygotsky, 1997, p. 119).

In Vygotsky’s view, both thought and language result from the interactions between individuals within the context of their socio-historic culture (Vygotsky, 1962; Leontiev, 1978; Luria, 1992). Adopting a contemporary version of this position,

Radford (2006) describes thinking as a result of a reflective praxis mediated by the body, signs and tools – a dialectic movement between a historically and culturally constituted reality and the individual who reflects upon it (Radford, 2006). Following the steps of Leontiev, Radford and Roth (2011) stress the *personal senses* that emerge in instructional situations as individuals attribute their own subjective meanings for the objective meanings of the objects under study. Although subjective, these meanings are necessarily social, in that they are moulded by shared cultural signs of those who participate in the situation.

We concur with this view, but believe it is important to recognise that in the socio-historic practices that have come to characterise most mathematics classrooms, dialogues based on visuo-gestural forms of expression have only recently been considered and valued. In fact, for many years, deaf students were discouraged or even forbidden from using sign languages as a medium for learning. It is hence critical that we begin to investigate how the discursive practices of deaf learners might favour the process of transforming conceptual objects of culture (algebraic objects in this case) into objects of consciousness.

In this article, we focus on the interactions between a group of deaf students, their hearing teacher, an interpreter and hearing researchers that occurred as the students worked on activities involving generalisation. In each of the episodes we present, we attempt to identify evidence of algebraic thinking in the expressions of the students, using Radford's (in press) characterisation of algebraic thinking as comprised of three interrelated conditions, *indeterminacy*, *denotation* and *analyticity*. Indeterminacy refers to the condition that thinking algebraically involves problems with unknown, or undetermined, elements, in our case numbers. Denotation involves the need to name or symbolize the indeterminate numbers. For Radford, denotation does not necessarily involve the use of standard alphanumeric signs, “indeterminate quantities can also be symbolized through natural language, gestures, unconventional signs or even a mixture of these” (p. 4). The third condition, analyticity, implicates the treatment of the indeterminate elements as if they were known. That is, a student thinking algebraically will not need to assign a specific value to, say, an unknown number in order to operate with it.

With these three conditions in mind, in the remainder of the paper we present episodes from a series of tasks involving generalisation and consider aspects of the discursive practices of the deaf students that contributed to the production of generalisations and indicated the personal senses attributed to the notion of variable.

## THE EMPIRICAL PROCEDURE

Drawing from the methods associated with *Design Experiments* (Cobb *et al.*, 2003), the activities we have developed for deaf learners seek to privilege visual representations as starting points from which to motivate engagement in reflective and discursive practices. The activities discussed in this article represent the third and fourth sessions of a series of five, each of which occurred on a separate day and lasted

for approximately 90 minutes. The group of six deaf students, aged between 18 and 31 years, composed a 9th grade class who studied in the evenings at a school that was part of the public system of the municipal of Barueri, a town on the outskirts of the São Paulo conurbation. This school attends both deaf and hearing students, who usually study together, although for historical reasons this particular class included only deaf students.

During the research sessions, in addition to the teacher and interpreter, four other researchers were present. Three cameras were positioned in the classroom to record the interactions of all the participants. Additionally, in the three sessions involving the use of digital tools, three laptops were available and the on-screen activity was also recorded. In the first two sessions, the students worked on paper and pencil tasks involving visually presented sequences. Although the students successfully completed the activities, our analyses suggested that in terms of the sense of indeterminacy, one of the critical conditions of algebraic thinking, none of the tasks provoked in students a need to denote or operate with an unknown element. That is, the students were able to generate generalisations that they could use to locate any given term of the sequence, but for them it only made sense to do so once the value of the specific term required was identified. We might say that the idea of a general term did not figure in the shared dialogue (for more details on these two sessions, see Fernandes and Healy, 2013).

From the third session on, we decided to adopt a different approach. With the intention of encouraging students to identify the visual structure of a general term, we chose to work with the Mathsticks microworld, created in the Imagine version of the Logo programming language (Figure 1 presents an English version, the Portuguese version used in our study is available at [www.matematicainclusiva.net.br](http://www.matematicainclusiva.net.br)).

This microworld, originally described in Noss, Healy and Hoyles (1997), is designed to encourage students to produce a variable procedure (in the **history box**) that can be used to generate the set of terms for a given sequence. The elements of the sequence are mathsticks, created by clicking on the respective icons and positioned through four jump icons. When the **history box** is activated (turned **on**), a reusable symbolic trace of the users' actions is recorded in symbolic form as Logo commands. Sets of the commands can be repeated in a way that corresponds to how the sequence grows and the box labeled **n** can be used as a variable, allowing the same **history** to produce different terms in the same sequence (in Figure 1, the value of **n** is 5, hence the 5<sup>th</sup> term in the sequence is generated).

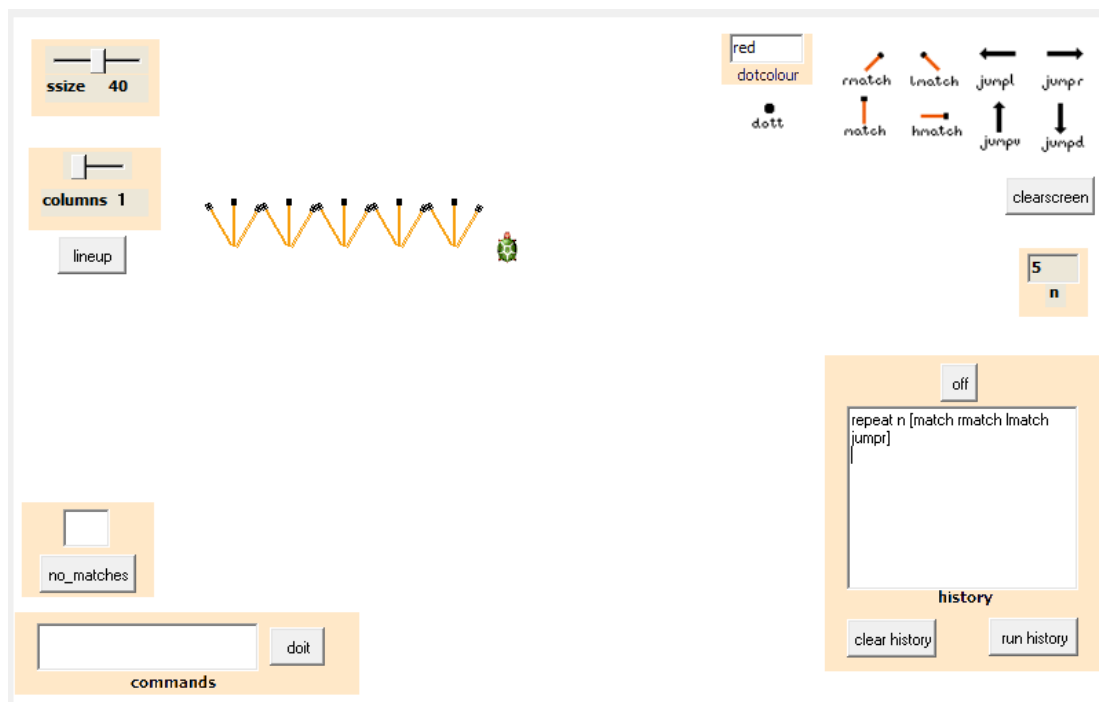

Figure 1: The Mathsticks Microworld

### STUDENTS' INTERACTIONS WITH THE MATHSTICKS MICROWORLD

The participating students had never used the Logo programming language before, nor were they accustomed to interacting with digital tools in their mathematics lessons. The first activity (Figure 2) hence had the aim of familiarising students with the microworld tools and their functions.

Program a history that draws all these figures

Write your history

<b>Figure</b>	<b>5</b>	<b>3</b>	<b>16</b>	<b>14</b>	<b>n</b>
<b>Number of sticks</b>					

Figure 2: The “L” task

To introduce the activity, the screen from the microworld was reproduced on the blackboard and, as the functions of the different tools were explained, the students experimented with them in pairs on the laptops. After seeing how a matchstick “L” could be produced, the students were shown how commands could be repeated in the **history box** to produce the 6<sup>th</sup> term of the sequence. At this point the **history box** on the blackboard contained the commands **repeat 6 [match hmatch jumpr]**.



Figure 3: Changing the number of repeats the board. (Figure 3).

The next step was to introduce variables, or more specifically the microworld variable **n** represented as a box on the screen. To illustrate its use, the commands in the **history box** were altered to **repeat n [match hmatch jump]**. Having explored the effect of changing the value of **n**, the students began to work in pairs to complete the table presented in the “L” task in Figure 2. They progressed without difficulty until the moment that they came to the column in which the number of matches in the  $n^{\text{th}}$  term was requested. Although they knew that each “L” shape was made up of two matches and found it straightforward to calculate the cases in which either the number of the term or the number of matches was known, faced with a (our) denotation of a variable they were unsure as to what was expected. We might say that although they had varied the value of **n** in their interactions with Mathsticks, their thinking was still predominantly arithmetic, and they were still operating only with known quantities. After having discussed their results and with a consensus that to determine the number of matches in any term it was necessary *always* to multiply the number of “Ls” by two, one of the researchers completed the table, writing  $n \times 2$ . Almost immediately, reflecting on this inscription, one of the students, Elaine, offered a new interpretation for **n**, signing “*n is a secret number*” (Figure 4).

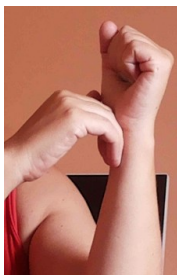

Figure 4: The Libras sign for “secret”

Our interpretation is that the denotation of the variable offered by Elaine was indicative of her developing personal sense of indeterminacy and the idea that it is possible to work with numbers without knowing their values. Indeed the sign for “secret” is itself suggestive of hiding something down one’s sleeve and only perhaps later revealing its value – a kind of bodily expressed metaphor for an unknown.

In creating the sign “secret number”, Elaine simultaneously expressed and shared her sense of the variable **n**. The creation of such signs is a common part of communicating in Libras, especially as official signs for mathematical terms such as “variable” do not always exist or, at least, are not widely known. Elaine’s sign was hence adopted forthwith as a means of referring to variables.

In the following session, the students worked on similar activities in which the structure of the terms became gradually more complex, Figure 5 presents an example, that we will call the “rectangle task”.

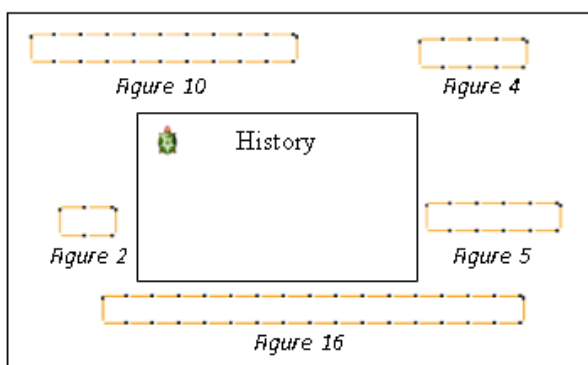

Figure 5: The rectangle task

In the activities that preceded this task, the general term could be written in the form **repeat n [procedure]**. In this task, however, while the number of horizontal matches varies as the sequence changed, there are always 2 vertical matches. Perhaps not surprisingly, all the student pairs began first by seeking a generalisation using the repeat structure that had worked in the previous activities.

Téo, for example, noticed how the number of horizontal matches increased and in his first attempt he wrote **repeat n [hmatch jumpu hmatch jumpd jumpv]**. When he tested the commands in the **history box**, using 12 as the value for **n**, he saw that the term was incomplete (Figure 6). He added the command **match** to the **history box** and, after considerable thought, completed the figure with the commands **repeat 12 [jumpv] match**. (Figure 7). He was very satisfied with the result.



Figure 6: First attempt



Figure 7: Completing the figure

When asked to explain why this addition had worked, he confidently signed the following answer

Téo: *12 here in n (pointing to the **box n** on the screen). So r e p e t i r (spells out the word letter by letter) 12 (pointing to the **repeat 12** in the **history box**). It has to be equal to n. An example, if it was 9 (points again to the **repeat 12**), it wouldn't work. It has to be 12 to be the same.*

To further illustrate his explanation, and what happens when “*n is different*” Téo changed **n** to 20 (Figure 8).



Figure 8: **n** equals 20

He immediately resolved the problem by changing the 12 to 20 and was then, asked if he could change commands in the **history box** so it was not longer to alter manually on each change to **n**.



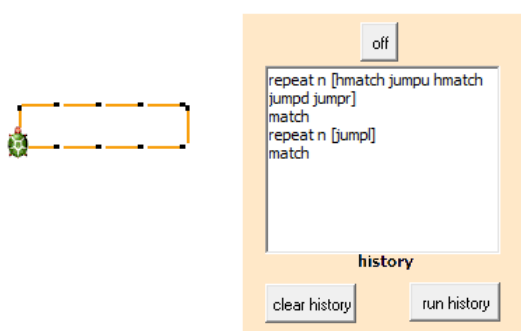

Figure 9: A general history

This intervention led to the replacement of **repeat 20** with **repeat n** and the new **history** was checked with different values for **n** (Figure 9 shows the term drawn when **n** is 4). In this construction procedure, we see traces of the analyticity proposed by Radford as the third condition for algebraic thinking, although, given the nature of the task, in this case it involves relating specific and general terms, rather than, say, operating on unknowns to locate particular values.

## DEAF LEARNERS' EXPRESSIONS OF MATHEMATICAL GENERALITIES

Marschark and Hauser (2008, p. 9), reflecting on instructional approaches appropriate to include deaf learners, remark that “the use of dynamic visual displays to accompany instructors’ verbal descriptions are especially helpful for learning”. The choices of the mediational elements in this study – the microworld, the tasks, and the language used – were made with this in mind: to respect but also to diversify the discursive practices preferred by deaf students. The dynamic representations of the Mathsticks microworld enabled the students to explore the visual structures of the sequences they encountered and the possibility to generate a symbolic representation of a general term by using a Logo variable appeared to serve as a meaningful introduction to indeterminacy and to favour the emergence of algebraic thinking.

In the examples presented in this article we have tried to show how the interactions of the students with the microworld, with each other and with us involved them in a process of coordinating bodily resources with visual, dynamic and linguistic signs in order to attribute meanings to mathematical objects. Their expressions during this process contain traces of the three conditions for algebraic thinking, indeterminacy, denotation and, albeit to a lesser degree, analyticity. For example, as Elaine offered a sign to denote her personal sense of the variable **n**, she also offered a means, that was shared and understood by the group, to reflect about the condition of indeterminacy and the sign “secret number” came to represent an as yet unknown (or unrevealed) number. The use of this sign was particularly important since these students were not yet familiar with more conventional semiotic systems used to represent indeterminate numbers, nor were they (or we) aware of signs in Libras for terms such as “variable”.

It is also interesting to focus on the form of the sign itself. Like many signs in Libras, there is a certain iconicity associated with the sign for “secret”, it evokes the idea of something being hidden up ones’ sleeve. The sign “secret number” expresses in a visuo-gestual form a particular incarnation of an algebraic variable that seemed to make sense to this student group. As we seek to better include deaf students in school mathematics, we believe that we need to attend more closely to the practice of communicating mathematics in this visuo-gestual form.

## Acknowledgements

We are grateful for the funding received from CAPES (Coordenação de Aperfeiçoamento de Pessoal de Nível Superior) which is contributing to the ongoing programme of research entitled *Towards an Inclusive Mathematics Education* (No. 23038.019444/2009) and for the grant received by Lulu Healy from CNPq (Conselho Nacional de Desenvolvimento Científico e Tecnológico). We would also like to thank Heliel Ferreira dos Santos, Fabiane Guimarães Vieira Marcondes and Kauan Espósito da Conceição who collaborated with us in the design and execution of the Mathsticks sessions.

## References

- Cobb, P., Confrey, J., Disessa, A., Lehrer, R., & Schauble, L. (2003). Design experiments in educational research. *Educational Researcher*, 32(1), 9-13.
- Fernandes, S. H. A. A., & Healy, L. (2013). Expressando generalizações em Libras: álgebra nas mãos de aprendizes surdos. *Caderno CEDES*, 33(91), 349-368.
- Leontiev, A. (1978). Marxism and psychological science. In *Activity, consciousness, and personality* (Chapter 1). (M. Hall, Trans.). Upper Saddle River, NJ: Prentice-Hall.
- Luria, A. R. (1992). The child and his behavior. In *Ape, primitive man, and child: Essays in the history of behaviour* (Chapter 3). (E. Rossiter, Trans.). Harlow, Essex: Harvester Wheatsheaf. (Originally published 1930)
- Marschark, M., & Hauser, P. (2008). Cognitive underpinnings of learning by deaf and hard-of-hearing students: Differences, diversity, and directions. In M. Marschark & P. C. Hauser (Eds.), *Deaf cognition: Foundations and outcomes* (pp. 3-23). New York: Oxford University Press.
- Noss, R., Healy, L., & Hoyles, C. (1997). The construction of mathematical meanings: Connecting the visual with the symbolic. *Educational Studies in Mathematics*, 33(2), 203-233.
- Radford, L. (2006). Elementos de una teoría cultural de la objetivación. *Relime—Revista Latinoamericana de Investigación en Matemática Educativa, Número Especial*, 103-129.
- Radford, L. (in press). The progressive development of early embodied algebraic thinking. *Mathematics Education Research Journal*.
- Radford, L., & Roth, W.-M. (2011). Intercorporeality and ethical commitment: an activity perspective on classroom interaction. *Educational Studies in Mathematics*, 77(2-3), 227-245.
- Vygotsky, L. S. (1997). *Obras escogidas V – Fundamentos da defectología*. (J. G. Blank, Trad.). Madrid: Visor.
- Vygotsky, L. S. (1962). The genetic roots of thought and speech. In E. Hanfmann & G. Vakar (Eds.), *Thought and language* (Chapter 4). (E. Hanfmann & G. Vakar, Trans.). Massachusetts: The MIT Press.

# SEEING IN SPACE IS DIFFICULT: AN APPROACH TO 3D GEOMETRY THROUGH A DGE

Francesca Ferrara<sup>1</sup>, Maria Flavia Mammana<sup>2</sup>

<sup>1</sup>Dipartimento di Matematica “Giuseppe Peano”, Università di Torino, Italy

<sup>2</sup>Dipartimento di Matematica e Informatica, Università di Catania, Italy

*In this paper, we present an approach to spatial geometry that involved a group of university students, who engaged in visual experiences while discussing about geometrical properties using a dynamic geometry environment. Drawing on aspects related to the difficulty of seeing in 3D, we introduce suitable connections between quadrilaterals and tetrahedra as a way to enhance visual skills in space geometry. In so doing, we show examples of the way learners manage “to see in space” through the affordances offered by the DGE.*

## INTRODUCTION

Discussing about relationships between space and geometry, Henri Poincaré (1905) pointed out that one geometry cannot be truer than another; it can only be more convenient. This much depends on our habit to work with geometrical objects in a certain way. Among all possible conventions, we are guided in choice by experience. For Poincaré, Euclidean geometry is the most convenient, because it is the simplest one, best adapting to our impressions and agreeing with properties of the natural solid bodies that we touch and see in the world around us.

3D geometry is not felt as convenient at all. At secondary school, where the study of geometry in space is expected, teachers show poor confidence about—and prefer to avoid—it, despite its relevance with respect to real world and scientific disciplines. The general reputation that spatial geometry is difficult is usually connected to the feeling that *seeing* in 3D is difficult (Bakó, 2003).

The question of *seeing* is likely to be the most important for our discussion. In fact, geometry in space involves visual challenges related to the ontological difference between three-dimensional objects and bi-dimensional diagrams that embody them. A pedagogical challenge then, is relative to studying approaches to 3D geometry that may encourage and foster seeing in space. Our study seeks to draw attention to this aspect and presents an approach to the study of spatial geometry that makes use of dynamic geometry environments (DGEs). The study is part of a wide research, whose focus is on the visual challenges involved in the study of objects in space and on the role of technology to address such challenges. To pursue our interest in seeing with respect to the use of DGEs, we anticipate that the discovery of relationships between geometric 2D and 3D figures is a crucial aspect of studying 3D geometry, and that the visual and cognitive potential of interlacing related but different figures is offered by the use of DGEs, allowing for moving back and forth between plane and space.

## THEORETICAL BACKGROUND

### Relevance of seeing in mathematics

Talking about his practice, Walter Whiteley highlights the central role of the visual:

I am a research mathematician, working in discrete applied geometry. My own practice of mathematics is deeply visual: the problems I pose; the methods I use; the ways I find solutions; the way I communicate my results. The visual is central to mathematics as I experience it. It is not central to mathematics as many teachers present it nor as students witness it. This contrast is striking. (Whiteley, 1994, p. 1)

The etymology of visual comes from the Latin word *visus* that means “sight”, or from *visus*, past participle of *videre*, which is “to see”. That visual thinking is essential for professional mathematicians has been studied in research in mathematics education (e.g. Healy & Hoyles, 1999). For Sfard (2008), visual mediators are fundamental elements of the discursive activity in/of mathematics, and “in spite of the famous “intangibility” of mathematical objects, mathematical communication depends on what we see no less than do other, less abstract types of talk” (p. 146).

Besides the fact that mathematicians do not see the same thing in a unique diagram, what is visual for the expert mathematician/the teacher is not always like that for an apprentice/a learner. The “striking contrast” said above opens room for pedagogical intervention to make mathematics—at least partly—a visible enterprise. Presmeg (2006) has marked the emergence of “effective pedagogy that can enhance the use and power of visualization in mathematics education” (p. 227). In mathematics teaching, visual approaches frequently give a straightforward perception of the results. For example, a square number is immediately thought of—seen—as the sum of even numbers through a diagram, where a suitable disposition of elements representing a sum of even numbers forms a square.

### Seeing and 3D geometry

The visual challenges involved in the study of spatial geometry are related to having to do with “flat” diagrams for geometrical figures, bi-dimensional representations of 3D objects. A study from the eighties had marked the existence of coding problems, in terms of *knowing* versus *seeing*, in the teaching of space geometry (Parzysz, 1988):

The problems of coding a 3D geometrical figure into a single drawing have their origin in the impossibility of giving a close representation of it, and in the subsequent obligation of ‘falling back’ on a distant representation [...] an insoluble dilemma, due to the fact that what one *knows* of a 3D object comes into conflict with what one *sees* of it. (pp. 83-84)

Moreover, perception of the third dimension greatly depends on the way we perceive depth and the cluttered space around us, and it is, in turn, a matter of how our eyes and mind measure reality and virtual reality. Different sources of information about layout can entail different fashions of measuring it and, then, of perceiving around us spaces with different geometrical natures (Cutting, 1997).

Within this perspective, we think that, in principle, the 2D diagram is far from seeing in it the 3D figure in the same measure as the 3D figure is far from diagramming it in the 2D diagram. Briefly speaking, the figural and the conceptual aspects of the figure are in conflict with each other, beyond their being in conflict with visual perception.

### Seeing something *as* something else

As Douglas R. Hofstadter reports in his chapter *On Seeing A's and Seeing As*, one time, in the context of an old debate with Giancarlo Rota, Stanislaw Ulam parried:

What makes you so sure that mathematical logic corresponds to the way we think? Logic formalizes only very few of the processes by which we actually think. The time has come to enrich formal logic by adding to it some other fundamental notions. What is it that you see when you see? You see an object *as* a key, a man in a car *as* a passenger, some sheets of paper *as* a book. It is the word 'as' that must be mathematically formalized.... (Hofstadter, 2005, p. 264)

The process of seeing something *as* something else, which was felt as impossibly hard by Rota, was on the contrary crucial for Ulam's idea of mathematical thinking as permeated with analogies between analogies—a point that is relevant for us to the extent that, drawing on Hofstadter, we think of “as” as central to “abstract seeing”, in terms of seeing 3D properties in flat diagrams. We believe that such a step requires a kind of manipulation that is not easy for high school students, because their previous studies of solids were likely to involve physical manipulation. This is where we think that the use of DGEs can further occasions for new experiences of engaging with the diagrams and discovering invariants and changes. Again, we can recall Hofstadter (1997), who refers to his screen-based observations as both facts and theorems:

To me, this result was so clearly true that I didn't have the slightest doubt about it. I didn't need a proof. If this sounds arrogant, let me explain. The beauty of *Geometer's Sketchpad* is that it allows you to discover instantly whether a conjecture is right or wrong—if it's wrong, it will be immediately obvious when you play around with a construction dynamically on the screen. If it's right, things will “stay in synch” right on the button no matter how you play with the figure. The degree of certainty and confidence that this gives is downright amazing. It's not a proof, of course, but in some sense, I would argue, this kind of direct contact with the phenomenon is even more convincing than a proof, because you really see it all happening right there before your eyes. None of this means that I did not want a proof. In the end, proofs are critical ingredients of mathematical knowledge, and I like them as much as anyone else does. I just am not one who believes that certainty can come only from proofs. (p. 10)

Starting from this background, in the next sections, we discuss an approach to spatial geometry that draws on a definitional “analogy” between two figures: quadrilateral and tetrahedron, using a DGE like Cabri Géomètre 3D. In so doing, we will show examples of what the participants manage to “see in space” through the affordances offered by the DGE.

## METHODOLOGY

### Participants, tasks and data collection

The participants of the study were a group of 12 university students (age 22) enrolled in a Foundations of Mathematics class in a Faculty of Mathematics in Eastern Sicily. The classroom was divided into groups of two or three students, and each group was seated in front of two computers in a computer laboratory. The computers had one Cabri II Plus and the other Cabri 3D installed. The teacher (second author) describes the students as motivated and comfortable working with each other and using both the DGEs and their dragging modality. The study took place towards the end of the second semester of the academic year in the participants' regular classrooms. At the time, the participants have learned about key invariants with respect to transformation groups. They did not have experienced with exploring 3D Euclidean geometrical concepts in class, nor before but in their junior high school studies.

Each group was first introduced to a new definition of quadrilateral that differs from the traditional one—a quadrilateral is a polygon with four sides—in that it adds what are the edges and faces of a quadrilateral. Second, the groups were given the task of drawing the bimedians of a quadrilateral and investigating the properties that the constructed objects satisfy, through the aid of Cabri II Plus. Then, for the purpose of comparing properties for quadrilaterals and for tetrahedra, the students were asked to discuss the movement to space using the *Redefinition* tool and the *Glassball* modality of Cabri 3D, about which they learned during this classroom.

One week later, the groups were given two main tasks: introducing the medians for quadrilaterals and tetrahedra, and conjecturing about the properties that hold in both cases. For the tasks involving bimedians and medians, the groups were given a Cabri 3D diagram that was new to them, in which a quadrilateral was drawn on the (grey) base plane—a plane given by default by the DGE. Finally, the students were asked to discuss possible proofs to show the validity of their claims in plane and in space.

Each day, two researchers (the authors) were present in class. They gave the groups the instructions and videotaped the group works with the DGEs and the classroom discussion at the end of the day. All written productions and DGEs' diagrams were collected. The aim was to analyse which kinds of visual skills the students were able to construct during the activity, whose relevant aspects are detailed below.

### Quadrilaterals and Tetrahedra

The analogy between quadrilaterals and tetrahedra was established by introducing the definitions of edges and faces for a usual quadrilateral as follows: the segments joining two vertices of the quadrilateral are its *edges* and the triangles with vertices three vertices of the quadrilateral are its *faces*. In a quadrilateral there are six edges, the four sides and the two diagonals, and four faces, exactly as many as a tetrahedron.

So, we are able to look at—and *see*—figure ABCD, which has four vertices (A, B, C, D), six edges (AB, AB, BC, CD, DA, AC, BD) and four faces (ABC, ABD, ACD,

BCD), indifferently as the tetrahedron ABCD, whether we think that it lives in space, or as the quadrilateral ABCD, whether we think of it as a plane figure. We call  $F$  the figure ABCD. Given  $F$ , two *opposite edges* do not have common vertices and a face and a vertex are *opposite* when the vertex does not belong to the face. Moreover, we can define the *bimedians* and *medians* of  $F$  as: the segments that join the midpoints of two opposite edges; and the segments that join one vertex with the centroid of the opposite face, respectively. These objects satisfy some interesting properties:

- A. The three bimedians all pass through one point (that is, the centroid of  $F$ ) that is the middle point of each bimedian.
- B. The four medians all meet in its centroid that divides each median in the ratio 1:3, the longest segment being on the side of the vertex of  $F$ .

As said above, the students were instructed to using the *Redefinition* tool and the *Glassball* modality of Cabri 3D. Let us make a thought experiment: imagine what would happen to a quadrilateral if one vertex was moved off the plane where it lies. The figure that was before ontologically became a new figure: the flat figure *is* now a solid figure; the polygon *is* now a polyhedron. It *is* as a consequence of the *movement* of the vertex off the plane.

The *Redefinition* tool realises this movement, redefining one point as an ontologically different point. For example, given the quadrilateral ABCD on the base plane (Figure 1a), one can *redefine* vertex D to be a point in space, exactly the apex D of the tetrahedron with base the face ABC (Figure 1b). The quadrilateral *is* a tetrahedron *within the DGE*, not necessarily in what the students see on the screen. The dragging and the *Glassball* modalities also allow for checking whether things “stay in synch”—in Hofstadter’s words. In particular, the latter makes possible a rotation of the figure in order to actualise many virtual points of view from which to look at it.

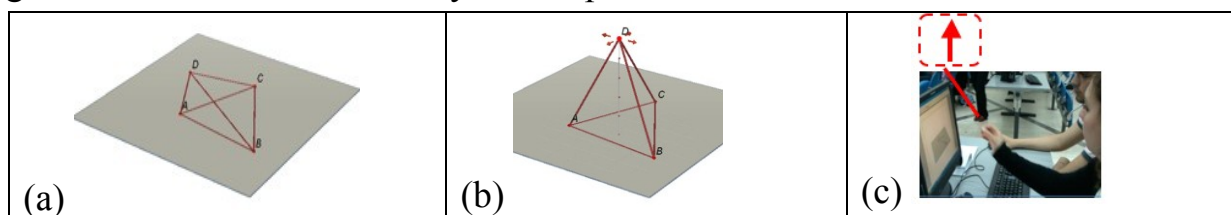

Figure 1(a) & (b): A quadrilateral ABCD on the base plane and the redefinition of point D for the tetrahedron ABCD. Figure 1(c): S gesturing the imagined movement.

## DATA ANALYSIS

In this section, we present kinds of seeing in space that students developed in the tasks. The analysis is divided into two parts each containing a brief transcript and reference to the theoretical frame, for the purpose of identifying seeing in each part.

### Seeing and Knowing

The following is a transcript of the initial interaction of three students, M, S and V, with the redefinition of one vertex of a quadrilateral using Cabri 3D. They had drawn without problems the four vertices and the six edges on the base plane. Before using the *Redefinition* tool, the teacher (T) proposed a thought experiment:

- 1 T: Let's try to extract a vertex from the plane. Imagine to redefine... rather,  
2 let's make two things. If I ask you: Extract a vertex from a plane, what do  
3 you think that it's gonna happen?
- 4 V: <S gestures with two joined fingers moving up (Figure 1c)> It shapes  
5 a kind of pyramid with a triangular base.
- 6 T: It becomes a pyramid with a triangular base. <M drags a vertex to see the  
7 triangular pyramid, but as soon as he uses the Glassball modality he  
8 realises that the dragged point is on the plane. So, he drags the point back  
9 on the visible grey part of the base plane>
- 10 V: If I extract the centre it becomes a square based pyramid.
- 11 T: What is the centre?
- 12 V: The point where the diagonals meet.
- 13 T: You find the Redefinition tool under the *Manipulation* button.

When the students were invited to “imagine” the new situation, gestures appeared that reflected knowledge about the transformation underwent by the quadrilateral. V easily imagined “a kind of pyramid with triangular base”; she was seeing the pyramid with her mind (lines 4-5). Instead, M immediately dragged the point to see the pyramid within the DGE. However, the *Glassball* modality, which he used to check the stability of the solid shape, revealed that “the dragged point is on the plane”, contrary to M’s expectation (lines 7-9). M wanted to see the guessed pyramid as a result of dragging, without knowing that a different tool was needed. Dragging only allows for moving the vertex on the base plane, even though it seems that it is off the plane once one sees it on the screen outside the visible grey part. This created a conflict between seeing and knowing that pushed M to drag the point back (line 8). At this time, V also imagined the solid obtained when “the centre” is extracted (line 10). However, since the students had no tools to check their conjectures, the teacher introduced the position of the *Redefinition* tool within the DGE.

### Seeing something as something else

After the *Redefinition* tool was used to move the point and see the pyramid, the groups were given the 3D diagram with a quadrilateral on the base plane together with its bimedians. Slightly before knowing the task, M and S started to play around with the redefinition of one vertex. The teacher got close to ask them what happened:

- 14 M: It [the quadrilateral] becomes a tetrahedron. (...)
- 15 T: <T talks about the bimedians> Do they continue to meet?
- 16 M, S: Ya.
- 17 T: Where did they meet? <T reads what M and S wrote before “the bimedians  
18 meet in a point H. H divides the bimedians into two equal parts”> Does this  
still happen?



- 19 S: Hmm, at sight it seems to do, yea <M and S looks at the figure on the screen>

This brief extract shows that, thanks to the *Redefinition* tool, M and S came to see, and think of, the figure on the screen no longer as a quadrilateral but as a tetrahedron (line 14). This change was felt by the teacher, who drew attention to the continuity of the transformation (line 15), in order to push the student-pair to visually recognise (“at sight it seems”, line 19) that what was happening before is actually an invariant under the transformation (“still happen”, line 18). A similar reaction occurs when the two students explore the 3D diagram with a quadrilateral and its medians:

- 20 S: It's the same thing.  
 21 M: Ya, it is.  
 22 S: It's always upside-down. <S refers to the tetrahedron with vertices the  
 23 centroids of the faces that they have constructed>  
 24 M: “A” corresponds to “A”, and the others as well. [being A one vertex and A'  
 25 the centroid of the opposite face] The same properties hold.

Invariants were also grasped in the case of medians, in which seeing something as something else started to entail seeing the “the same thing” (line 20) in the figures and seeing “the same properties” holding for both (line 25). The use of “always” was significant here because it marked that the student-pair was generalizing (line 22). When the properties were discussed collectively, the students were given one final Cabri 3D file containing two figures that seemed to be exactly the same:

- 26 T: What are the figures? What do you see? <Some students say “pyramids”>  
 27 E: They're pyramids because we're using Cabri 3D.  
 28 C: No! The one on the left is a quadrilateral, the one on the right a pyramid.  
 29 T: How do you know?  
 30 C: I dragged the vertices, there are no projections on the left, yea on the right.  
 31 S: <T asks “What about you?”> The same, but we used the Glassball.  
 32 T: They might seem the same object, but they are not. We have seen that the  
 33 same definitions and properties hold for both figures. Then, does it  
 34 actually matter what they are? <Students answer “No!”>  
 35 Ss: No!

This last transcript clearly points out that, at the end, the students needed to use the resources of the DGE for distinguishing between the given figures: the fact of being within Cabri 3D does not really help to see them as different figures (lines 27-28). Instead, the dragging modality for seeing whether projections were present, or the *Glassball* tool for changing the point of view, gave them real answers (lines 30-31), even though it did no longer “matter what they are” (lines 35-37).

## CONCLUDING REMARKS

Our examples showed that seeing in 3D involved for learners visual challenges that had mainly to do with conflicts between knowing and seeing and with the perception of the third dimension in flat diagrams. However, we found interesting the way these challenges were faced within the environment of Cabri 3D. The *Redefinition* tool and the *Glassball* modality, together with usual dragging, were resources for the students. In fact, they encouraged the students to take on multiple perspectives, as if they were taking on various physical positions from which to see a figure, as bodily projecting themselves both beyond and around it. So, they engaged the students in dynamic visual experiences with the diagrams, effecting new kinds of vision that pushed them towards a search for similarities and differences, invariants and changes, between quadrilaterals and tetrahedra. This engagement spoke directly to students' enhanced visual skills, so that they not only came to see the quadrilateral *as* a tetrahedron, but also to see them, when thought of as represented in a diagram, as "the same thing". For space constraints, we could not discuss our examples deeply, but we believe that they could form a basis for furthering effective future research.

## References

- Bakó, M. (2003). Different projecting methods in teaching spatial geometry. In M. A. Mariotti (Ed.), *Proc. 3<sup>rd</sup> Congress of the European Society for Research in Mathematics Education*. Bellaria, Italy: CERME.
- Cutting, J. E. (1997). How the eye measures reality and virtual reality. *Behaviour Research Methods, Instruments, & Computers*, 29(1), 27-36.
- Healey, L., & Hoyles, C. (1999). Visual and symbolic reasoning in mathematics: Making connections with computers? *Mathematical Thinking and Learning*, 1(1), 59-84.
- Hofstadter, D. R. (1997). Discovery and dissection of a geometric gem. In J. King & D. Schattschneider (Eds.), *Geometry turned on: Dynamic software in learning, teaching, and research* (pp. 3-14). Washington, DC: The Mathematical Association of America.
- Hofstadter, D. R. (2005). On seeing A's and seeing As. In S. Franchi & G. Güzeldere (Eds.), *Mechanical bodies, computational minds* (pp. 249-264). Cambridge, MA: The MIT Press.
- Parzysz, B. (1988). "Knowing" vs "seeing": Problems of the plane representation of space geometry figures. *Educational Studies in Mathematics*, 19(1), 79-92.
- Poincaré, J. H. (1905). *Science and hypothesis*. London: Walter Scott.
- Presmeg, N. (2006). Research on visualization in learning and teaching mathematics. In A. Gutierrez & P. Boero (Eds.), *Handbook of research on the psychology of mathematics education: Past, present and future* (pp. 205-235). Rotterdam/Tapei: Sense Publisher.
- Sfard, A. (2008). *Thinking as communicating: Human development, the growth of discourse, and mathematizing*. Cambridge, MA: Cambridge University Press.
- Whiteley, W. (2004, July). *Visualization in mathematics: Claims and questions towards a research program*. Paper presented at the 10<sup>th</sup> International Congress on Mathematical Education, Copenhagen, Denmark.

# MATHEMATICAL ACTIVITIES IN A SOCIAL LEARNING FRAMEWORK: HOW MULTIMODALITY WORKS IN A COMMUNITY OF PRACTICE

Francesca Ferrara<sup>1</sup>, Oi-Lam Ng<sup>2</sup>

<sup>1</sup>Università di Torino, Italy; <sup>2</sup>Simon Fraser University, Canada

*In this paper, we explore an approach to understanding how multimodality works in a community of practice. Using a social learning framework, we show how a community of practice, involving a pair of high school students, engaged in perceptual, bodily, and imaginary experiences while discussing about calculus concepts in a dynamic geometry environment. Our findings suggest that learners' multimodal experiences emerge in both visible and invisible uses of the artefact and are situated in the mathematical activities. This study enriches our understanding about how students participate in the mathematical activities with dynamic geometry environments.*

## INTRODUCTION

This paper brings multimodality in the lens of social learning, in particular, of community of practice. While many studies using Lakoff and Núñez's (2000) ideas have provided insights into the embodied and multimodal nature of mathematical cognition, this line of work tends to focus on thinking in the individual sense rather than with respect to the social nature of learning. Adopting the non-dualistic view that mathematical *thinking* is part and parcel of *doing* mathematics, we see here compatibility with conceptualising learning as participating in mathematical activities in a community of practice.

Our study seeks to apply the idea of multimodality—seen as an interplay of perceptual, bodily and imaginary experiences situated in the resources at play (Ferrara, 2013)—in social dimensions of learning (Lave & Wenger, 1991; Wenger, 1998). Toward a greater purpose, we hope that the results of our study will provide a better understanding of how multimodality “works” in a community of practice and in social learning contexts involving artefacts. Moreover, to pursue our interest in multimodality with respect to the use of dynamic geometry environments (DGEs), we anticipate that the notion of *transparency* under this framework can be meaningfully extended to the kinds of multimodal experience upon mathematical activities using DGEs. Within this perspective, we investigate:

- What repertoire of resources do learners use as they participate in mathematical activities using a DGE?
- What kinds of *visible* and *invisible* mathematical (multimodal) “talk” do learners develop as they participate in mathematical activities using a DGE?

## THEORETICAL PERSPECTIVES

### **Social dimensions of learning: Community of practice and transparency**

A community of practice is a unit of social interaction situated in practice; it is part of a broader framework for conceptualising learning in its social dimensions (Wenger, 1998). This perspective suggests that learning is located, not in the heads or outside of the individual, but in the relationship between a social person and a social world. Meaning-making in social contexts requires a dual process of participating in-action and reifying actions into artefacts:

On the one hand, we engage directly in activities, conversations, reflections, and other forms of personal participation in social life. On the other hand, we produce physical and conceptual artifacts—words, tools, concepts, methods, stories, documents, links to resources, and other forms of reification—that reflect our shared experience and around which we organize our participation. (Wenger, 2010, p. 180).

The interplay between participation and reification is dynamic: the person and the world intertwine to shape meaning both individually and collectively. Over time, this creates a social history of learning and a dynamic social structure that define a community of practice. Participants use a set of criteria and expectations to recognise membership in a community of practice, which include: an understanding of what the enterprise of the community is (*domain*), mutual engagement in the activity (*community*), and appropriate use of the repertoire of resources that the community has accumulated through its history (*practice*).

Lave and Wenger (1991) also posit that, when learners work within communities of practice, a dual visibility—*visibility* and *invisibility*—develops in the use of artefacts with respect to their *transparency* for the communicating subjects.

Invisibility of mediating technologies is necessary for allowing focus on, thus supporting visibility of, the subject matter. Conversely, visibility of the significance of the technology is necessary for allowing its unproblematic—invisible—use. This interplay of conflict and synergy is central to all aspects of learning in practice: It makes the design of supportive artifacts a matter of providing a good balance between these two interacting requirements. (Lave & Wenger, 1991, p. 102).

In the case of using a mediating technology like a DGE, transparency means that the DGE fades into the background and becomes a means by which participants achieve something else. On the other hand, if the DGE remains to be the focus, there is little room for learning about its affordances—it will be a black box that is in control. This invisible and visible character of the DGE allows for considering its relevance in communities of practice and its relationship to learning about particular domains.

### **Multimodality in mathematical activities**

In the special issue on gesture and multimodality in mathematical thinking, Radford et al. (2009) point out that in our acts of knowing, different sensorial modalities—tactile, perceptual and kinaesthetic—become integral parts of our cognitive processes. Other

studies discuss gestures in mathematics teaching and learning, with respect to teacher's gestures in relation to students' meaning making (Arzarello *et al.*, 2009), the cultural dimension of gestures (Radford, 2009), and the role of gestures in mathematical imagination (Nemirovsky & Ferrara, 2009).

Further contributing to the discussion on multimodal mathematical cognition, Ferrara (2013) describes how multimodality manifests, that is, "as a constitutive expression of thinking, which encompasses complex networks of perceptual, sensory-motor and imaginary experiences" (p. 19). In particular, it is proposed that the contemporary and entangled emergence of such experiences shapes mathematical thinking on the one hand, and, on the other hand, is shaped by the resources at play.

It is this idea of multimodality that we think works suitably in the lens of social learning and of community of practice, where the resources at play are relevant both for the community and for the practice at hand, and at the same time strictly contextual in terms of the domain of interest.

## METHODOLOGY

### Participants, task and data collection

The participants of the study were two pairs of 12<sup>th</sup> grade students (age 17) enrolled in an AP Calculus class in a culturally diverse high school in Western Canada. In the class of 26 students who all volunteered to participate in the study, the participants, R, G, J, S, were selected. They were selected randomly as a group of four because they had been seated in the same row in their regular calculus classroom and were regular partners during assigned group and pair-work activities. Their teacher (second author) describes them as motivated and comfortable working with each other. The study took place at the end of the first trimester of the school year in the participants' regular calculus classroom, outside of school hours. At the time, the participants have just finished learning about key concepts in differential calculus using an iPad-based DGE called *Sketchpad Explorer*. So, students have experienced with exploring and discussing, in pairs, calculus concepts such as derivative, derivative functions and related rates through geometrical, dynamic sketches.

The participants were divided into two pairs, and each pair was asked to discuss two different sketches presented in *Sketchpad Explorer*. For the purpose of comparing patterns of communications, they were given one sketch that they had seen before in class and another sketch related to a topic that was new to them. For example, the pair R and G were given a sketch related to the definition of derivative which they have seen before, and then a sketch related to area-accumulating functions (Figure 1a and b) which was new to them (they had not learned the topic of area-accumulating functions in class). The researcher gave the instructions, turned on the videotaping function of the camera facing the student-pairs, and then left the room, until the students finished talking about all the diagrams. Each student-pair took around 25 minutes on completing the task for each session.

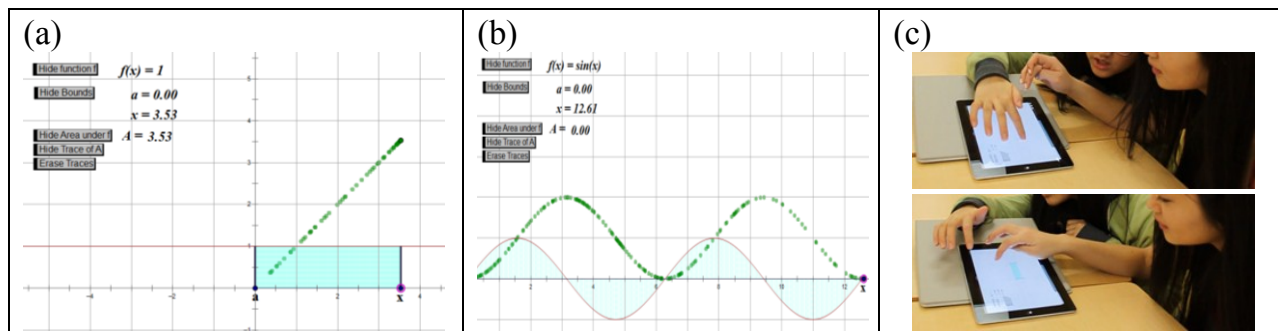

Figure 1(a) & (b): A dynamic sketch used in the study (with all *Hide/Show* buttons, “*Show function*”, “*Show bounds*”, “*Show Area under f*”, and “*Show Trace of A*” activated). The bounds “*a*” and “*x*” are draggable; the green traces represent function  $A(x) = \int_a^x f(t)dt$ . Figure 1(c): Snapshots of R and G interacting with the sketch.

## DATA ANALYSIS

In this section, we extend the notion of transparency to analyse the use of the DGE and the kinds of multimodal experiences that one of the student-pairs, R and G, developed in the task. The analysis is divided into three parts each containing a condensed transcript, for the purpose of identifying themes in each part.

### Visible talk: Exploring *Hide/Show* buttons and dragging

The following is a transcript of R and G’s initial interaction with the first page of the sketch (see Figure 1a). At the start, all buttons were in the “hide” position, except for the “show function” button, which showed a constant function on the page.

- 1 G: So this is like a straight line. What is show bounds? So there is an interval, so it’s like a domain. <G presses the “show bounds” button>
- 2
- 3 R: Can we change this one? Can we change “a”? <G drags “a”>
- 4 G: No, no, no, make it zero. Show area under “f”. <G presses the “show area under f” button>
- 5 R: What’s this point? Can we move it? <R taps on the green trace trying to move it>
- 6 G: Show, show, what’s trace of “A”? <G presses the “show trace of A” button>
- 7 R: What are you doing?
- 8 G: I don’t know, I’m just, oh, when you are moving it, it’s graphing like the area, or, no, ya, ya, it’s just graphing the area. <G drags the entire rectangle horizontally>
- 9
- 10 R: Oh, interesting, and it goes up and down. <R drags point “a” horizontally>
- 11 G: Well yeah, ’cause you’re making the area.
- 12 R: Can I move “x” still? Oh, interesting... <R drags point “x” horizontally>
- 13 G: So if you just move “x”, area is a positive slope. What if you just move “a”?

14 R: It's the up and down thing.

The 3-minute transcript highlighted the way R and G entered visible “talk” about the dynamic sketch. It showed that the student-pair was trying to learn *how* to use the “black box” sketch by exploring the functions of the *Hide/Show* buttons and dragging the points “a” and “x” respectively. As the students had yet to fully grasp the many buttons in the sketch, they posed questions three times in lines 1, 4, 6 to inquire the functions of each button, “*Show bounds*”, “*Show area under f*”, and “*Show trace of A*” as each button was pressed. Since their perceptual and bodily experiences were focussed on the use of the *Hide/Show buttons*, it can be said that at this point, they attended to the buttons *visibly* rather than *invisibly*. The students also seemed unsure about what to do with the two draggable points “a” and “x” initially and therefore tried to use dragging as a resource to investigate the behaviour of the points. This was evident in lines 3 and 13, where R asked G if they could “change” “a” and then “move” “x”. The word use of “can” in both questions suggests that R did not know if the points were draggable, and therefore, proposed to drag “a” and “x” for the purpose of learning about the sketch. R and G’s use of the resources at hand, particularly the draggable points (that are used as parameters) gave relevant feedback about the enclosed area, allowing the two students to begin the process of *imagining* how the area would change and behave as a function.

### **Invisible talk: Gesturing, dragging, and using the Trace tool**

After about 5 minutes of interacting with the first page, the students moved onto a new page of the sketch, which initially showed the sine curve (see Figure 1b).

- 15 R: Oh, sine. It's gonna be complicated, it's gonna be crazy.
- 16 G: Oh, is it “cos”? No, it's not. <G drags “x” horizontally continuously>
- 17 R: It's like it's been shifted, transformed.
- 18 G: So this is the area right now, so when “x” equals to 3, the area is like 1.2.
- 19 R: So “a” is always gonna be there, and “x” is the one that's always gonna
- 20 like, where it corresponds.
- 21 G: No you can move “a”, when you move “a”, it's just a vertical line <G drags “a”>
- 22 R: But it's always gonna stay with “x”. The “x” moves at *x* and *y* direction
- 23 G: And then if you just move “x”, it's a vertical line, wait, no it's not. <G drags “x”>
- 24 R: It's still moves it like this. <R makes “wave” gestures> It's just when you move
- 25 “a”, then it's like up and down. <R gestures with one finger moving up and down>

The transcript opens with G dragging the point “x” horizontally back and forth, therefore tracing a function  $A(x)$  that was sinusoidal (line 16). Then, R and G consistently used words like “now”, “it”, “this” and present continuous verb forms

(verb that ends with “-ing”) to talk about the state of the sketch. For example, the students took turns to describe what the green traces looked like, referring to the traces as “it” (lines 16 and 17). Then, G started to drag “x” horizontally and said “so *this* is the area right *now*” (line 18). Perceiving the green traces created by G’s dragging, R responded that the x-coordinate of green traces “always corresponds” (line 19). They moved on to describe the green traces left by dragging “a” which would create a “vertical line” (line 21).

The episode shows that the student-pair moved from questioning about technology to talking *invisibly* about the sketch. The students used the *Hide/Show* buttons and dragged points “a” and “x” purposefully, without struggling with their functions as they did previously. They shifted their focus on the discussion from the act of *dragging* from earlier to the *results* of dragging—and towards *invisible* use of the DGE. During this discussion, R performed two hand gestures using her right index finger to describe the shape of the traces. First, she made “wave” gestures (Figure 2a) to explain that the green traces should be sinusoidal (line 24); then she made “up and down” gestures (Figure 2b) to explain the vertical movement of “a” (line 25), when “x” and “a” were dragged respectively. These gestures provide further evidence that the students were engaging in *invisible*, multimodal “talk” around the DGE.

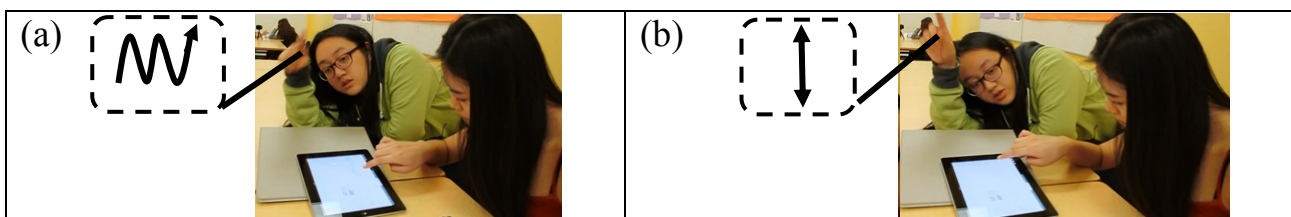

Figure 2(a): R’s “wave” gestures, and (b): “up and down” gestures.

Through dragging and gesturing, the students extended their perceptual and bodily experiences. Moreover, the *Trace* tool and shaded area gave feedback about the relationship of the green traces and the area under curve, which enabled the students to *imagine* the possible shape of the corresponding area-accumulating function. It is also worthy of note that the coordination of the two students that reveal their real being of a community of practice: one drags and the other gestures; one moves depending on the movement of the other.

### Visible and invisible talk: Confirming conjectures with dragging

- 34 R: There’s probably some formulas, a generic formula for all of this.
- 35 G: So the area gets, it goes like big and small, big and small. <G drags “x”>
- 36 R: Wait, move “a” next to “x”, right on top, it goes zero right? <G drags “a”  
37 *over top of “x”*> Yes it’s zero. Move one of them somewhere.
- 38 G: So “x” increases positively. <G drags “x” to the right from  $x=0$ >
- 39 R: Wait, move it so that it’s at the top of the curve, where does it go when  
40 it’s at the top? Ok, so this grows from here to here, which represents the  
41 area of the whole. <G drags “x” towards  $\pi$ >



- 42 G: Yea, so it's just like the entire thing, but then it will go back down.
- 43 R: Yea it goes negative so it takes away from it. So once we finish this hump,  
 44 it should be zero, yea it comes back to zero. <R drags "x" towards  $2\pi$ > The  
 45 area is always, when you graph the point, it's always gonna be at the "x",  
 46 not the "a".

After about 8 minutes of interacting with the sketch, the transcript shows that R and G began to talk about the significance of the DGE sketch. This was evident in the way the students talked about a generic "formula" (line 34) to relate the green traces with "a" and "x" as well as their use of dragging to confirm their predictions about the sketch. In particular, they made conjectures such as the green trace should reach zero when "a" was dragged towards  $x=0$  (lines 36-37), and that it should go up and back down before arriving at the next zero when "x" was moved towards  $2\pi$  (lines 39-44). The students' *imaginary* experience was met by perceptual and bodily experiences through perceiving the traces left by dragging. Having confirmed their results, they used high modality words such as "will" (line 42), "should" (line 44) and "always" (line 45) to generalise the ways the green traces should behave. Although they were not able to communicate about the area-accumulating function  $A(x)$  clearly, the students grasped the meaning of the green traces, marked by their mutual engagement towards predicting their shape. This suggests that they develop *dual visibility* in the use of the dynamic sketch: unproblematic use and understanding the significance of the DGE.

## DISCUSSION

In this section, we direct our discussion with regards to our exploratory approach of applying multimodality in a social learning framework, and the extent to which this approach informed understanding of how multimodality "works" in a community of practice. First, our analysis shows that the student-pair constituted a community of practice. The two students shared a "domain" of interest to advance mathematical knowledge in their activity with the DGE; they were also mutually engaged and used a repertoire of resources in the activity. Some have critiqued the idea that classroom settings do not reflect communities of practice, but we have shown that communities of practice, as units of social interaction situated in practice, may exist in pair-work mathematical activities when students understand and share the goal of the activity.

Secondly, the students used a repertoire of resources in their activities with the DGE, such as the *Hide/Show* buttons, the dragging modality, and the *Trace* tool that they possibly developed through their history of learning during the first trimester of the course. These resources enabled them to initially enter *visible* talk about the DGE, and later talked about the dynamic sketch *invisibly*. After about 8 minutes of interacting with the sketch, they conjectured about the shape of the green traces and used the dragging modality to confirm their predictions. Their unproblematic use of the DGE and ability to talk of the significance of the sketch supports the claim that they had found a "balance" between visible and invisible uses of the DGE.

Thirdly, the students' interactions with the dynamic sketch were analysed both within the lens of transparency and multimodality. Aligned with both the social learning framework and Ferrara (2013) on multimodality, visible and invisible DGE use shaped the students' mathematical thinking on one hand, and on the other, their participation in the activities were constantly shaped by the resources at play. Their participation involved talking, perceiving, dragging, gesturing and imagining, that is, multimodal experiences. In particular, these experiences are situated in the dynamic sketch. The sketch's dynamic essence gave rise to the functional relationship between variables,  $a$ ,  $x$ , and  $A(x)$ , which the student-pair exploited by dragging and gesturing. These perceptuo-bodily acts, which were also dynamic in nature, led to the students' imagining of the tracing of the green point that was dynamic in nature as well.

In conclusion, our approach did enrich our understanding of how students participate in the mathematical activities with the DGE. In our illustrated episode, we found it helpful to extend the notion of transparency to students' multimodal experiences in mathematical activities. This combined framework informed the interplay between transparency of talk, in a multimodal sense, and the resources at play—the DGE. Because of the scope of the paper, we were not able to examine the evolving discourse between a less experienced user of the DGE (new-comer) and a more experienced user of DGE (old-timer) in mathematical activities. We believe that this process of participation could form the basis for fruitful future research.

## References

- Arzarello, F., Paola, D., Robutti, O., & Sabena, C. (2009). Gestures as semiotic resources in the mathematics classroom. *Educational Studies in Mathematics*, 70(2), 97-109.
- Ferrara, F. (2013). How multimodality works in mathematical activities: Young children graphing motion. *International Journal of Science and Mathematics Education*. doi: 10.1007/s10763-013-9438-4
- Lakoff, G., & Núñez, R. (2000). *Where mathematics comes from*. New York: Basic Books.
- Lave, J., & Wenger, E. (1991). *Situated learning: Legitimate peripheral participation*. Cambridge: Cambridge University Press.
- Nemirovsky, R., & Ferrara, F. (2009). Mathematical imagination and embodied cognition. *Educational Studies in Mathematics*, 70(2), 159-174.
- Radford, L. (2009). Why do gestures matter? Sensuous cognition and the palpability of mathematical meanings. *Educational Studies in Mathematics*, 70(2), 111-126.
- Radford, L., Edwards, L., & Arzarello, F. (2009). Beyond words. *Educational Studies in Mathematics*, 70(2), 91-95.
- Wenger, E. (1998). *Communities of practice. Learning, meaning and identity*. Cambridge: Cambridge University Press.
- Wenger, E. (2010). Communities of practice and social learning systems: The career of a concept. In C. Blackmore (Ed.), *Social learning systems and communities of practice* (pp. 179-198). London: Springer.

# THE TEACHING ACTIVITY AND THE GENERATION OF MATHEMATICAL LEARNING OPPORTUNITIES

Miquel Ferrer, Josep M. Fortuny, Laura Morera, Núria Planas

Universitat Autònoma de Barcelona, Spain

*We present a case study that has been developed to inform about the teaching activity of a secondary mathematics teacher in a whole group discussion and the mathematical learning opportunities generated for the students in this classroom context. For data of one lesson we determine the episodes that shape the whole group discussion. For each episode we then examine the effects of the observed actions on the type of learning that can be encouraged. Our research reveals significant relationships between the teaching activity of the teacher and the creation and potential exploitation of mathematical learning opportunities on the part of the students.*

## INTRODUCTION

Research in the field has seriously addressed the study of social interaction as an element to build learning in small group work (Sfard & Kieran, 2001), but little is still known about the construction of mathematical knowledge in the course of whole group discussions (Saxe et al., 2009). We assume that these discussions are a crucial resource for mathematics teaching, since they can facilitate the students' learning. Under this assumption in our work we seek to investigate to what extent and how the teaching activity mediates the generation and potential exploitation of mathematical learning opportunities in the mathematics classroom. In this report we summarize a case study (of a teacher and a lesson) whose results have come to inform about the following goals: (a) to characterise the type of teaching activity of a secondary mathematics teacher in a whole group discussion, and (b) to identify mathematical learning opportunities generated for the benefit of the students in this context.

## TWO THEORETICAL DIMENSIONS AND A KEY NOTION

We base the analysis of what we call the episodes of a whole group discussion on the articulation of two dimensions: the instrumental dimension, about the artefacts and the way in which these are used in class, and the discursive dimension, about the interactional patterns that help to understand the generic development of the episodes and some of the particular characteristics shared among them. Therefore, two coordinates and the qualitative type that each coordinate takes define an episode.

In the understanding of the instrumental dimension, six types of orchestration are considered: *exploring the artefact*, *explaining through the artefact*, *linking artefacts*, *discussing the artefact*, *discovering through the artefact* and *experiencing the instrument*. The first three types are focused on the teacher's actions and the last three on the students' actions. They are all inspired by the initial types constructed by

Drijvers and his colleagues (2010), but have been generalised in our research for instructional situations in which the design and implementation of whole group discussions do not necessarily contain an intensive use of technological artefacts.

The discursive dimension is also framed in terms of types that are named stages of the discussion of a problem. They are presented as a sequence of activities that illustrate the process of conducting a whole group discussion toward the resolution of a problem. The stages are organised according to an idealized development of the resolution process: *situating the problem, presenting a solution, studying different solutions or explanatory strategies, studying particular or extreme cases, contrasting solutions, connecting with other situations, generalising and conceptualising, and reflecting on mathematical progress*. Later in the report we exemplify an episode with the coordinates *discussing the artefact* and *contrasting solutions*.

More generally, we interpret episodes as systems of actions that have occurred in the course of the discussion. Our interest is on the effects of actions as some of them may foster basic procedural and/or conceptual mathematical learning (Niss & Højgaard, 2011). Differently to how episodes are seen, actions are tied to the subject performing the action, either student or teacher, and their role in the organisation of participation in whole group discussion. To consider the role of the actions performed by the teacher, we draw on the classification by Schoenfeld (2011): *classroom management actions, discussion actions* and *mathematical content actions*, depending on whether they refer to the organisation of the classroom and its participants; to the development of mathematical activities; or to the mathematical content of the activities as well as the teacher's ability to listen to the students, and become aware of their difficulties and of the aspects that they understand better or worse.

### **Mathematical learning opportunities**

The interpretation of whole group discussions in terms of sequences of episodes and actions has to do with our understanding of interaction as a crucial place for the development of mathematical learning. Various authors have researched the broader topic of mathematical learning opportunities for the case of students (Yackel, Cobb, & Wood, 1991). We consider mathematical learning opportunities as relationships between contents of mathematical knowledge, which are liable to be procedural and conceptual, together with actions that potentially contribute to facilitate the students' learning. These opportunities are identifiable through and from actions generated by diverse situations in the interaction processes of the mathematics classroom.

Several distinct actions can be at the origin of the appearance and possible exploitation of learning opportunities. Classroom actions are a combination of multiple interaction processes, in which the students and the teacher as well as the use of artefacts contribute to the creation and development of relevant instructional situations that can in turn foster the students' mathematical learning (Cobb & Whitenack, 1996). Accordingly, the study of learning opportunities requires the prior systematic preparation, examination and assessment of instructional situations.

## DESIGN EXPERIMENT AND DATA

Drawing on the tradition of design experiments in mathematics education research, we designed and implemented an instructional sequence of Geometry with similarity problems. Two teachers conducted it in two classrooms over a total of eight lessons with 8th graders (13 and 14 years of age). In this report we have selected the case of the teacher who at the moment of the experiment had an average teaching experience and was working in an urban school of a medium-high sociocultural area.

Figure 1 shows the first problem in the sequence, whose wording presents an open approach and whose resolution is tied to the activation of high cognitive tasks of proportional thinking. There is more than one solution strategy and connections need to be made with the underlying mathematical concepts (e.g., shape, area, ratio).

***Introductory activity 1: Double figures!***

Given the following letter from the alphabet, represent another letter which is twice the size. Below, briefly explain how you obtained it and compare it with the original.

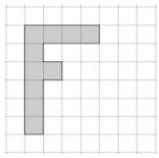

Figure 1: Formulation of the first problem

The work dynamics is collaborative and begins with the paper-and-pencil resolution in pairs. It continues with a 20-minute whole group discussion, and finishes with the students' written individual reflections. Two of the authors were present in the lesson, but did not intervene in the development of the activity. During the whole group discussion three video cameras recorded the interventions made by participants and these were later transcribed for the purpose of the analysis.

The classroom recordings were examined in order to: (a) divide the whole group discussion into episodes, determine the actions that take place in them and, thus, obtain a description of the teacher's activity when managing the lesson; (b) study the effects of the actions on the type of learning that is encouraged and detect and classify the mathematical learning opportunities generated during group discussion. In the next section we illustrate the application of the methods to one episode.

## EXAMPLE OF ANALYSIS

First we divided the whole group discussion around the resolution of the problem of Figure 1 into nine episodes. We classified them according to a type of orchestration (instrumental dimension) and a discussion stage (discursive dimension), and we searched for the observed actions of the participants. The nine episodes with their nine corresponding coordinates provide organized information about the teacher's activity when managing the whole group dynamics in the selected lesson.

The fifth episode (*discussing the artefact, contrasting solutions*) of the whole group discussion lasted three minutes. We briefly explain the major phases of the analysis of the episode. In the transcript below, the teacher addresses questions to discuss and obtain a definition of similar polygonal figures. The conversation begins with the projection of solutions onto a screen using dynamic geometry software; this is why we assign the type *discussing the artefact* for the instrumental dimension. As two interpretations of the problem wording are compared, resulting in two different solutions, a figure with twice the perimeter and another with twice the area, we assign the stage *contrasting solutions* for the discursive dimension.

- 1 Teacher: [to Student 1] What did you understand? Why did you create this, [figure with twice the perimeter] and not this? [figure with twice the area].
- 2 Student 1: Because these two are the same [the original F and the one with twice the perimeter].
- 3 Teacher: Okay, then, the definition of similarity... Why do you think they are two similar figures?
- 4 Student 1: All the sides multiplied by a number, always the same.
- 5 Teacher: Okay, so, how are the sides?
- 6 Student 1: Proportional.
- 7 Teacher: Proportional, okay. And what else is needed?
- 8 Student 2: All the angles need to be equal.
- 9 Teacher: Here we won't check the angles because it's an F and it's evident that all the angles are  $90^\circ$ , but we should always check.

The system of actions that have occurred in the episode is also studied and represented by means of a sequence. We distinguish those performed by the students, named participation actions, from those by the teacher, named intervention actions. On the one hand, we mark the description of all actions with italics in the expanded narrative (italics are also used in the description of the mathematical learning opportunities). On the other, the intervention actions are more generally classified and thought of in relation to issues of classroom management, discussion and mathematical content (see the three columns of Figure 2, with the exemplification of the sequence of actions of the third type in the fifth episode).

At the start of the episode the teacher *requests an explanation* [1] from Student 1 as to why he created a figure with twice the perimeter instead of twice the area. The student observes the two representations projected on the screen and reveals that his choice was based on the similarity of the figure whose sides are proportional to the original. We interpret this action as *observation of empirical evidence* [2], since the visual information provided by the artefact helps him to verify a specific mathematical fact, but without this action implying or having the function of justification. Next, the teacher uses the situation to introduce the concept of similar figures and *requests*

another explanation [3] so that any volunteer defines it. Again, it is Student 1 who uses the representation on the screen to explain that two similar figures must have all the sides multiplied by a number, and that this number must always be the same. However, we interpret this action as *empirical justification* [4], because the student uses the representation projected on the artefact as a complement to his oral explanation and the diagram legitimises his statement. As Hanna (2000, p. 15) states, “the visual representation is used not only as evidence for a mathematical statement, but also in its justification [...] since diagrams can convey insight as well as knowledge.”

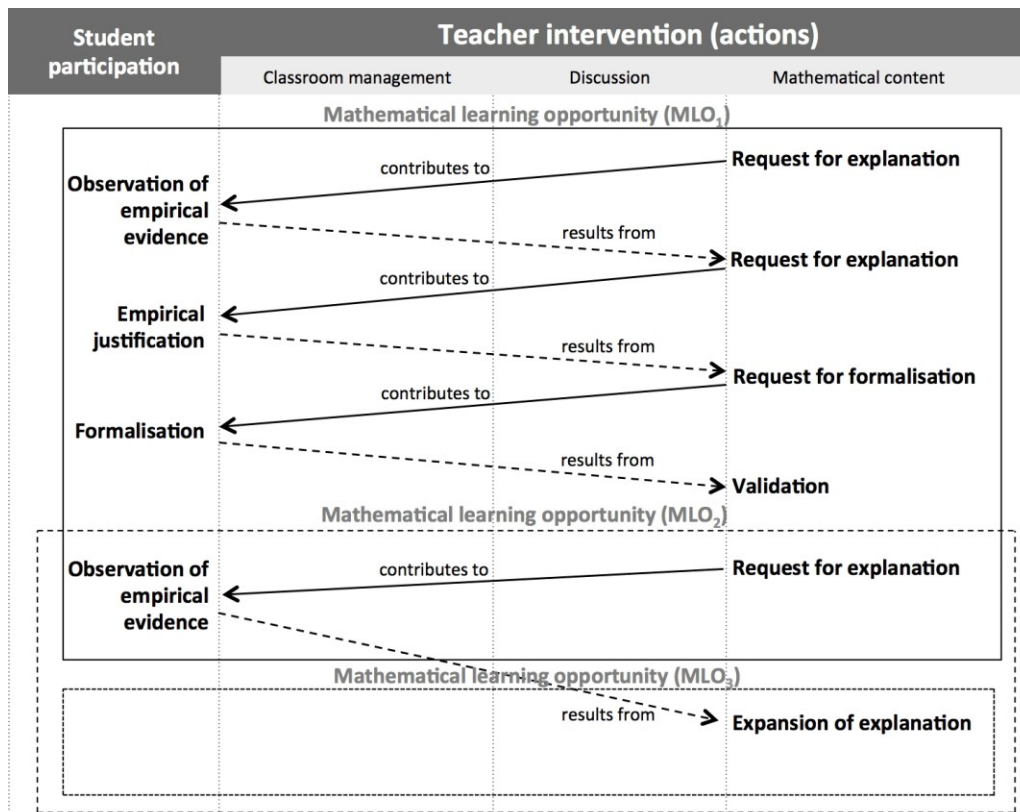

Figure 2: Representation of a sequence of actions in the episode

Later in the episode, the teacher *requests formalisation* [5] to specify particular technical language and to ensure the use of the term ‘proportional’ [6]. She *validates the reasoning* by Student 1 and *requests further explanation* [7] so that the students complete the definition. Another student uses the construction on the screen *to observe the empirical evidence* [8] that two similar polygonal figures, in addition, must have equal angles. We interpret that Student 2 does not use the artefact to support a mathematical reasoning, but to prove a concrete mathematical fact. Lastly, the teacher *expands the explanation* [9] by this student and states the importance of the equality of angles in the definition of similarity.

In Figure 2 we see that the structure of the sequence of actions presents linked series of interventions between the teacher and the students. This interactional pattern is reproduced in the other eight episodes of whole group discussion in the lesson, since

the teacher gives almost no explanations, but manages the discussion with the questions that she asks and mainly elaborates her talk on the students' responses.

The analysis of the teaching activity comes when the analyses of all nine episodes have been finished. In total they reveal an orchestration that is equally focused on the teacher and the students. There are five episodes corresponding to the three first types of orchestration (*exploring the artefact*, *explaining through the artefact* and *linking artefacts*) and four corresponding to the last ones (*discussing the artefact*, *discovering through the artefact* and *experiencing the instrument*). The accomplishment of the idealized discussion stages is almost complete and their distribution is sequential from the stages of the initial moments of the discussion (*situating the problem* and *presenting a solution*) to the later ones (*generalising and conceptualising*).

### **Identification of mathematical learning opportunities**

After having represented the sequence of actions for each episode, we are ready to relate the effects of the actions on the type of learning that they can encourage and to identify the mathematical learning opportunities, particularly focusing on the mathematics. For the fifth episode, our analysis suggests that various participation actions by the students can encourage procedural learning, linked to mathematical processes and focused on statements about facts perceived by the students during the debate (e.g., observations of empirical evidence), or on specific clarifications about mathematical aspects (e.g., formalisations). Other actions may encourage conceptual learning, linked to the students' empirical justifications and reasoning, which are centred on the development of mathematical concepts (e.g., notion of shape).

In a similar way, we explore the effects of the intervention actions by the teacher on the type of learning. These are the prioritised actions in the analysis due to our interest in the characterization of the teaching activity. As an example, we pay attention to the effects of mathematical content actions that refer to requests for explanation of mathematical methods or verification as they may encourage procedural learning (e.g., formalisations and validations). Also, this type of actions may encourage conceptual learning in relation to mathematical contents that are specific to the task (e.g., proportion and ratio) through the expansion of the students' explanations. In conjunction with classroom management and discussion actions, three mathematical learning opportunities appear.

The teacher's intervention at the start of the episode, requesting an explanation, initiates a debate that ends with the correct statement of the definition of similarity [1-8]. Therefore the situation generates a conceptual learning opportunity, that of *interiorising the concept of similarity and understanding its definition* (see Figure 2, MLO<sub>1</sub>). Although the teacher's questions are crucial to bringing about this situation, the opportunity arises as a result of the participation of students. Student 1 refers to the term 'similar' in his observation of the empirical evidence [2] and Student 2 responds to the teacher and completes the statement introduced by his peer [8].



The request for explanation by the teacher [7], asking about the additional elements that characterise the similarity of two polygonal figures, generates another conceptual learning opportunity, that of *identifying the equality of angles in the definition of similarity* (see Figure 2, MLO<sub>2</sub>). Although Student 2 makes an empirical observation stating that the homologous angles of the two figures must be the same, the opportunity arises as a result of the teacher's question, without comments of students directly leading to it.

The teacher's expansion of an explanation [9], emphasising the need to verify the equality of angles in order for the two figures to be similar, generates an interpretative and argumentative mathematical learning opportunity that we see as procedural. This is defined by *realising the importance of being rigorous in the elements constituting a mathematical definition* (see Figure 2, MLO<sub>3</sub>). Again it is the teacher with her teaching activity who mainly contributes to its generation.

## RESULTS AND FINAL DISCUSSION

We have shown to what extent and how the teaching activity of a teacher in a lesson mediates the creation and potential exploitation of mathematical learning opportunities in whole group discussion. The first goal was to characterise the teaching activity. Our analysis of the instrumental and discursive dimensions suggests that the class is managed with an orchestration that is equally focused on the teacher and the students, and an organised accomplishment of the discussion stages. The distribution of actions in the fifth episode reveals linked sequences of questions and answers in an interactional pattern that alternates teacher and student interventions.

The second goal was to identify the mathematical learning opportunities generated during the lesson. We have shown participation and intervention actions that seem to be at the origin of opportunities. The effects of some of these interrelated actions are likely to generate two major learning types: procedural and conceptual. To identify the opportunities, we have related the mathematical knowledge aspects of the opportunity with the effects of the actions that potentially facilitate their learning. Thus, we have observed that the mathematical learning opportunities occur in multiple discursive and instrumental situations. The data shown in this report only illustrates some of the many opportunities that were generated in all the episodes of the discussion. If looking at all of them, it can be inferred that the teaching activity is a strong mediator of mathematically significant actions whose effects may generate mathematical learning. Our results suggest that the activity by the teacher, which is balanced in orchestration and complete in the accomplishment of the stages, encourages the creation of diverse mathematical learning opportunities, which can be exploited by the students. Further research can be undertaken in this direction to find distinct degrees of exploitation of opportunities during whole group discussions.

## Acknowledgements

This work is funded by Projects EDU2011-23240 and EDU2012-31464 and by Grant FPI BES-2012-053575, Spanish Ministry of Economy and Competitiveness.

## References

- Cobb, P., & Whitenack, J. W. (1996). A method for conducting longitudinal analyses of classroom video recordings and transcripts. *Educational Studies in Mathematics*, 30, 213-228.
- Drijvers, P., Doorman, M., Boon, P., Reed, H., & Gravemeijer, K. (2010). The teacher and the tool: Instrumental orchestrations in the technology-rich mathematics classroom. *Educational Studies in Mathematics*, 75, 213-234.
- Hanna, G. (2000). Proof, explanation and exploration: An overview. *Educational Studies in Mathematics*, 44, 5-23.
- Niss, M. A., & Højgaard, T. (Eds.). (2011). *Competencies and mathematical learning: Ideas and inspiration for the development of mathematics teaching and learning in Denmark* (IMFUFA No. 485). Roskilde: Roskilde Universitet.
- Saxe, G., Gearhart, M., Shaughnessy, M., Earnest, D., Cremer, S., Sitabkhan, Y., ... Young, A. (2009). A methodological framework and empirical techniques for studying the travel of ideas in classroom communities. In B. Schwarz, T. Dreyfus, & R. Hershkowitz (Eds.), *Transformation of knowledge through classroom interaction* (pp. 203-222). New York: Routledge.
- Schoenfeld, A. H. (2011). *How we think. A theory of goal-oriented decision making and its educational applications*. New York: Taylor & Francis.
- Sfard, A., & Kieran, C. (2001). Cognition as communication: Rethinking learning-by-talking through multi-faceted analysis of students' mathematical interactions. *Mind, Culture, and Activity*, 8(1), 42-76.
- Yackel, E., Cobb, P., & Wood, T. (1991). Small-group interactions as a source of learning opportunities in second-grade mathematics. *Journal for Research in Mathematics Education*, 22(5), 390-408.

# CONNECTING A MATHEMATICS TEACHER'S CONCEPTIONS AND SPECIALISED KNOWLEDGE THROUGH HER PRACTICE

Eric Flores, José Carrillo

University of Huelva, Spain

*The aim of this paper is to show connections between a teacher's conceptions about the teaching and learning mathematics reflected in the planning designed by a secondary level mathematics teacher, and the specialised knowledge deployed both at the design stage and in the teacher's reflections after the lesson. The research method followed was an instrumental case study via content analysis. The study contributes to the development of an analytical model for studying mathematics teachers' specialised knowledge.*

## INTRODUCTION

In Skott, Van-Zoest and Gellert (2013), there is a call for research into the connections between mathematics teachers' knowledge, conceptions, and identity. In this work, we focus on the two-way connections between a mathematics teacher's conceptions and her specialised knowledge in the context of several typical practices.

By considering the design of, and reflection on, various class activities, we study the knowledge brought into play by a mathematics teacher at the planning stage, and the connections between this knowledge and the teacher's conceptions about teaching and learning the subject.

Viewed from a cognitivist perspective (Ponte, Quaresma & Branco, 2012), we consider the design of learner tasks, their management and the teacher's subsequent reflection upon them, as something which embraces multiple professional practices. In this instance, we consider the teacher's intentions, management and reflections regarding the interaction of the activities with her pupils and with hypothetical situations arising from aspects of the plan.

In response to the teacher's plan, which takes an experimental approach with equally likely outcomes, we delve deeper into the Conceptions about Mathematics Teaching and Learning (CMTL) reflected in the design itself, and seek to locate the specialised knowledge brought into play via descriptors drawn from the corresponding subdomains of the Mathematics Teacher's Specialised Knowledge model [MTSK] (Carrillo, Climent, Contreras & Muñoz-Catalán, in press).

## THEORETICAL FRAMEWORK

In this section, we situate the study within the ambit of professional practice, focusing discussion on the practices of anticipating and interpreting the pupils' modes of thinking, and on the teacher's classroom management and *post hoc* reflections. As

regards specialised knowledge, we draw on the subdomains of MTSK and its corresponding theoretical underpinnings. Finally, we consider the notion of conception, and the position we take in this respect *vis-à-vis* the interpretation of the data extracted from the design of the activities.

### **Mathematics teachers' professional practices**

We consider professional practice as anything which forms part of the teacher's workload which is closely related to the promotion of their pupils' learning (e.g. Branco & Ponte, 2012). Viewed thus, professional practices go beyond the teacher's role *at the front of the class* and include activities which are undertaken outside the classroom. Such scenarios of professional practice offer plentiful opportunities to deepen our understanding of specialised knowledge (Flores, Escudero, & Aguilar, 2013). Below we cite examples of professional practices noted by various researchers (including unintentional ones), and indicate those we analyse in this study.

Stein, Engle, Smith and Hughes (2008) propose a series of professional (interdependent) practices for orchestrating productive discussions about mathematics, which they sequence thus:

- (1) anticipating likely student responses to cognitively demanding mathematical tasks, (2) monitoring students' responses to the tasks during the explore phase, (3) selecting particular students to present their mathematical responses during the discuss-and-summarize phase, (4) purposefully sequencing the student responses that will be displayed, and (5) helping the class make mathematical connections between different students' responses and between students' responses and the key ideas. (p. 312)

Most of these practices directly involve the teacher's interaction with their pupils. Nevertheless, behind each, especially that of anticipating, is the need for a practice undertaken outside the classroom in the form of planning and reflecting on the outcomes of the lesson.

Ponte *et al.* (2012) describe and discuss two common practices, the presentation of tasks to students and group discussions. They propose a framework for studying these practices, which is intended to be serviceable irrespective of whether such studies take a cognitivist or sociocultural approach. The framework considers:

- (1) the teacher's aims, the way in which these give rise to achievable objectives, and how they are given shape through various professional actions, [...]
- (2) the social context and the educational context, [...]
- (3) the classroom context, [...]
- (4) the teacher's professional knowledge, [...]
- (5) the teacher's know-how, [...]
- and (6) the teacher's capacity for reflection. (p. 84)

In our study we focus specifically on the facets numbered 1, 4 and 6 above.

In their model of Mathematical Knowledge for Teaching (MKT), Ball, Thames and Phelps (2008) include within the knowledge subdomain they dub Specialized Content Knowledge (defined as the mathematical knowledge and skill unique to teaching) elements such as:

Teaching [...] requires understanding different interpretations of the operations in ways that students need not explicitly distinguish [..., teachers] must be able to talk explicitly about how mathematical language is used [...]; how to choose, make, and use mathematical representations effectively [...]; and how to explain and justify one's mathematical ideas. (p. 400)

In Flores, Escudero and Carrillo (in press), the authors conclude that, more than identifying mathematics teachers' specialist knowledge, the examples describe tasks forming part of teachers' work, and that different kinds of knowledge (mathematical, syntactic, learning styles and others) are required for teachers to carry these out. In other words, although the authors talk about SCK in terms of knowledge, what is actually exemplified seems to relate closer to the idea of mathematics teachers' professional practice.

The professional activity on which we focus in this paper is the design of classroom tasks, and we explore aspects of conceptions and knowledge, looking at three professional practices: the prediction and the interpretation of the pupils' way of thinking, and the *post hoc* reflection by the teacher involved in the study.

### **Mathematics Teacher's Specialised Knowledge**

Various models relating to mathematics teachers' professional knowledge are available (e.g. Usiskin, 2002; Bretscher, 2012). In particular, MTSK focuses on the study of the kind of knowledge which is relevant only to mathematics teachers (Escudero, Flores, & Carrillo, 2012). This model is based on consideration of two of the knowledge domains proposed by Shulman (1986), Mathematical Knowledge (MK) and Pedagogical Content Knowledge (PCK), and offers a refinement (e.g. Montes, Aguilar, Carrillo, & Muñoz-Catalán, in press) to the knowledge subdomains proposed in MKT by Ball et al (2008). It seeks to address, principally, two issues detected in MKT – the difficulty in demarking some subdomains from others, and the tendency of some descriptors not to be phrased purely in terms of elements of knowledge (Carrillo *et al.*, in press).

In MTSK, there are three subdomains in respect of MK: Knowledge of Topics, KoT (including phenomenological aspects, meanings, definitions, and examples characterising aspects of the topic of study), Knowledge of the Structure of Mathematics, KSM (including an integrated system of connections which enables advanced concepts to be understood and developed from an elementary perspective, and elementary concepts from an advanced one), and Knowledge of the Practice of Mathematics, KPM (knowledge of the forms of knowing, creating and producing in mathematics, knowledge of aspects of mathematical communication, reasoning and proof). Three other subdomains are considered in PCK: Knowledge of Mathematics Teaching, KMT (knowledge of different strategies enabling the teacher to develop procedural and conceptual mathematical abilities, knowledge of the potential of resources, examples and other means of representation for making a specific content more comprehensible, and knowledge of educational theory relating to mathematics), Knowledge of Features of Learning Mathematics, KFLM (knowledge of the

characteristics of the pupils' learning process for different contents, the language associated with each concept, and potential errors, difficulties and obstacles, theoretical knowledge about learning mathematics) and Knowledge of Mathematics Learning Standards, KMLS (knowledge of what the pupils should/can achieve by the end of a particular school year, knowledge of the procedural and conceptual abilities and mathematical reasoning promoted in specific educational stages).

MTSK offers this study useful categories for exploring knowledge. We start with general questions arising from the nature of the two knowledge domains and analyse these with specific categories drawn from each subdomain.

### **Conceptions of teaching and learning mathematics**

We understand a conception as the “conscious or unconscious [set of] beliefs, concepts, meanings, rules, mental images and preferences concerning mathematics” (Thompson, 1992, p. 132).

Leatham (2006) takes a position regarding the study of conceptions, with which we concur. Introducing the term Sensible System Framework, the paper suggests that rather than focusing on inconsistencies between declared conceptions, those inferred from classroom performance and those drawn from teacher reflections, all such aspects could be observed as a sensible system which accounts for itself. We also agree that conceptions represent a predisposition towards action and that they cannot be directly observed or measured, only inferred.

For data analysis, we used the categories and indicators put forward by Carrillo (1998), which, in terms of CMTL, distinguishes four kinds of conceptions (referred to as teaching tendencies in order to foreground the difficulty of ascribing an individual teacher to any single conception): the traditional, the technological, the spontaneous, and the investigative. Again, it should be stressed that these categories are not designed for placing teachers in particular boxes according to their conceptions, but it is the case that teachers tend to show predilections towards the indicators of one tendency or another.

### **METHOD**

The research design follows that of an instrumental case study (Stake, 1994), and was carried out by means of content analysis (Bardin, 2002). The study itself is part of a wider study seeking to establish connections between varying elements of MTSK.

The work uses the indicators described by Carrillo (1998) to identify the CMTL reflected in the design of activities by a secondary level mathematics teacher (Carol), and we allowed the rationale underpinning this design to guide our analysis.

The identification of the specialised knowledge Carol brought into play was achieved through an open-ended interview in which she was presented with hypothetical situations. The interview was structured according to the tasks that Carol had used in class, and focused on the following aspects of MTSK:

With respect to knowledge of content: (a) the knowledge she expected her students to learn; (b) the knowledge she used, or could have used, in the design and execution of the tasks and in reflecting on the results; and (c) the knowledge which, as researchers, we anticipated could be appropriate to planning the tasks, carrying them out and reflecting on the results.

With respect to pedagogical content knowledge: (d) knowledge of the students' habitual ways of working; (e) knowledge of the ways in which the students' thinking develops; and (f) knowledge of teaching strategies which promote specific behaviour in the students.

## RESULTS

This section is divided into three parts. The first talks about our findings regarding the CMTL reflected in Carol's design. The second part concerns the items of specialised knowledge we identify with the help of the design itself and Carol's responses in the open-ended interview and the hypothetical situations. Finally, we suggest connections between the CMTL and the items of knowledge identified.

### **The rationale of the design: inferred conceptions**

Carol's design consisted in choosing which result would appear most frequently when an object is thrown, first a coin, and second a dice. The complete rationale of the design (with each object) is thus: (a) predicting which event will occur the most number of times on throwing an object  $n$  times; (b) experimenting, recording the results and comparing these with the prediction; (c) predicting which event will occur the most number of times on throwing an object  $m$  times ( $m > n$ ); (d) experimenting, recording the results and comparing these with the prediction; (e) predicting which event will occur the most number of times on throwing an object  $s$  times ( $s > m$ ); and (f) dividing the number of times the pre-selected result occurred in the experiment by the total number of throws. In each stage, the students compare their results with those of classmates.

The repetition of predicting and experimenting was intended to guide the students towards recognising a pattern of equal probabilities, and this, taken together with the increased number of throws and the calculation of the quotient, indicates a conception of the acquisition of mathematical knowledge as a reproduction of the logical processes of the construction of content. For Carol, the significance of including experimentation in the class was both as a source of motivation encouraging student participation, and as a means of informally assessing student knowledge of the sample space of the event.

Although it is not our intention to categorise Carol as pertaining to a particular teaching tendency, the association she establishes between her design and the students' learning, based on the construction of meaning through the application of logical procedures, is a characteristic feature of the technological tendency (Carrillo, 1998).

### Knowledge based on MTSK

With respect to her knowledge of the theme of *equally probable events*, Carol demonstrates her understanding of the connections with this topic and that of fractions, percentages and sample spaces. Likewise, she distinguishes between those events which have equal probability and those in which certain outcomes are more likely to occur:

Carol: There are fewer combinations to add up [the faces of two dices] to appear *one* and *one* [...] the ones with a greater probability are the ones in the middle [...] there are events in which you can consider] previous results [so as to] predict, but it's by no means certain.

The knowledge represented here can be considered as pertaining to KoT (knowledge of connections between elements of a concept, definitions and properties). Nevertheless, although Carol recognises the importance of determining the sample space of the events, neither in her design, nor her subsequent reflections, does she include as part of the space the event of, at least, two outcomes occurring exactly the same number of times, although she does recognise that her students do not typically consider this event as part of the space.

Carol: My students never say it will turn out a draw [that heads and tails will occur an equal number of times], they choose either more heads or more tails, but not an equal number... well, perhaps a few say so, but most of them don't.

One area which is considered part of KFLM is that of predicting how students will think and act, and in this respect the teacher mentions strategies her students employ in predicting results based on previous outcomes, such as looking for patterns:

Carol: [My students] would have thought to themselves: "there's a pattern here, first I called heads and it came out tails, then I called tails and it came out heads, now I'll see if it comes out tails again [...] which gives them the same result" [out of 10 throws].

Carol regards experimentation as a learning strategy which, besides motivating the students, allows them to explore possible outcomes. Knowledge of such teaching strategies which directly bear on mathematical content is considered part of KMT.

As for mathematical knowledge recognised by the researchers as being necessary to Carol's design, this consists of fully determining the sample space (that is, the consideration that at least two outcomes might occur an equal number of times), and knowledge of Bernoulli's experiment for deliberately choosing the number of experimental repetitions.

### Potential connections between items of MTSK and CMTL

The analysis has brought to the fore the appearance of features of the technological teaching tendency. Although all teachers need knowledge of the logical processes of constructing the mathematical knowledge to be learnt by the students, the use of this knowledge is especially relevant in relation to the aforementioned features. According



to evidence drawn from Carol's lesson episodes, this has meant the incorporation of elements of distinct natures. On the one hand, the knowledge of definitions, connections within the concept and properties such as the law of large numbers, shows a deep knowledge of the topic which allows its reconstruction. On the other hand, with respect to knowledge of connections with more advanced topics, Carol considers it unnecessary for this lesson, although she admits to using more advanced knowledge than that actually deployed in class at other times in the planning phase. Carol's attested pedagogical content knowledge centres on the objectives of her plan and the impact this might have on her students, as a result of which there is an emphasis on being aware of the options facing the students when they come to do the activities, and the strategies they might employ, whether correct or incorrect, in carrying them out. Carol's knowledge in this respect bears features of a technological conception regarding the teacher's role, specifically, the transmission of knowledge through technological procedures and a presentation style in which she adopts the role of technician organising content and design.

## CONCLUSIONS

Through the case study of Carol's teaching we aimed to understand the two-way connections between conceptions and mathematics teachers' specialised knowledge. The study focused on various practices typical of mathematics teachers, and explored the utility of an emergent model designed to study the knowledge involved, MTSK. The connections are consistent in that the knowledge deployed by Carol (and likewise that which the researchers detect as potentially necessary) emerges from her intentions for the lesson. Further studies are clearly necessary to explore the connections between the multiple elements of teachers' knowledge, and the ways these impact on their teaching and their students' learning.

## Acknowledgements

This work has been supported by a grant from the Secretariat of Public Education and the Mexican Government.

The authors are members of the research project "Mathematical knowledge for teaching in respect of problem solving and reasoning" (EDU2009-09789EDUC), funded by the Ministry of Science and Innovation in Spain.

## References

- Ball, D. L., Thames, M. H., & Phelps, G. (2008). Content knowledge for teaching: What makes it special? *Journal of Teacher Education*, 59(5), 389-407.
- Bardin, L. (2002). *Análisis de contenido* (3ra edición). Madrid: Ediciones Akal.
- Branco, N., & Ponte, J. P. (2012). Developing algebraic and didactical knowledge in pre-service primary teacher education. In T.-Y. Tso (Ed.), *Proc. 36<sup>th</sup> Conf. of the Int. Group for the Psychology of Mathematics Education* (Vol. 2, pp. 75-82). Taipei, Taiwan: PME.

- Bretscher, N. (2012). Mathematical knowledge for teaching using technology: A case study. In T.-Y. Tso (Ed.), *Proc. 36<sup>th</sup> Conf. of the Int. Group for the Psychology of Mathematics Education* (Vol. 2, pp. 83-90). Taipei, Taiwan: PME.
- Carrillo, J. (1998). *Modos de resolver problemas y concepciones sobre la matemática y su enseñanza: metodología de la investigación y relaciones*. Huelva: Universidad de Huelva.
- Carrillo, J., Climent, N., Contreras L. C., & Muñoz-Catalán, M. C. (2013). Determining specialised knowledge for mathematics teaching. In B. Ubuz, C. Haser, & M. A. Mariotti (Eds.), *Proceedings of the 8<sup>th</sup> CERME* (pp. 2985-2994). Antalya, Turkey: CERME.
- Escudero, D. I., Flores, E., & Carrillo, J. (2012). El conocimiento especializado del profesor de matemáticas. In L. S. Moguel, E. A. Landa, & F. M. Rodríguez Vásquez (Eds.), *Proceedings of the XV Escuela de Invierno en Matemática Educativa* (Vol. 1, pp. 35-42). México, D. F.: Cinvestav.
- Flores, E., Escudero, D. I., & Aguilar, A. (2013). Oportunidades que brindan algunos escenarios para mostrar evidencias del MTSK. In A. Berciano, G. Gutiérrez, A. Estepa, & N. Climent (Eds.), *Investigación en Educación Matemática XVII* (pp. 275-282). Bilbao: SEIEM.
- Flores, E., Escudero, D. I., & Carrillo, J. (2013). A theoretical review of specialized content knowledge. In B. Ubuz, C. Haser, & M. A. Mariotti (Eds.), *Proceedings of the 8<sup>th</sup> CERME* (pp. 3055-3064). Antalya, Turkey: CERME.
- Leatham, K. R. (2006). Viewing mathematics teachers' beliefs as sensible systems. *Journal of Mathematics Teacher Education*, 9(1), 91-102.
- Montes, M. A., Aguilar, A., Carrillo, J., & Muñoz-Catalán, M.C. (2013). MSTK: From common and horizon knowledge to knowledge of topics and structures. In B. Ubuz, C. Haser, & M. A. Mariotti (Eds.), *Proceedings of the 8<sup>th</sup> CERME* (pp. 3185-3194). Antalya, Turkey: CERME.
- Ponte, J. P., Quaresma, M., & Branco, N. (2012). Práticas profissionais dos professores de Matemática. *Avances de Investigación en Educación Matemática*, 1, 65-86.
- Shulman, L. S. (1986). Those who understand: Knowledge growth in teaching. *Educational Researcher*, 15(2), 4-14.
- Skott, J., Van-Zoest, L., & Gellert, U. (2013). Theoretical frameworks in research on and with mathematics teachers. *ZDM-The International Journal on Mathematics Education*, 45(4), 501-505.
- Stake, R. E. (1994). Case studies. In N. K. Denzin & Y. S. Lincoln (Eds.), *Handbook of qualitative research* (pp. 236-247). Thousands Oaks, CA: Sage Publications.
- Stein, M. K., Engle, R. A., Smith, M. S., & Hughes, E. K. (2008). Orchestrating productive mathematical discussions: Five practices for helping teachers move beyond show and tell. *Mathematical Thinking and Learning*, 10(4), 313-340.
- Thompson, A. G. (1992). Teachers' beliefs and conceptions: A synthesis of research. In D. Grouws (Ed.), *Handbook of research on mathematics teaching and learning* (pp. 127-146). New York: McMillan.

# ONLINE MATHEMATICS TEACHER EDUCATION: MAIN TOPICS, THEORETICAL APPROACHES, TECHNIQUES AND CHANGES IN RESEARCHERS' WORK

Eric Flores<sup>1</sup>, Dinazar I. Escudero<sup>1</sup>, Mario Sánchez Aguilar<sup>2</sup>

<sup>1</sup>University of Huelva, Spain; <sup>2</sup>National Polytechnic Institute, Mexico

*We present a literature review of the emerging research area online mathematics teacher education (OMTE). The review focuses on identifying (1) the main issues investigated in the area, (2) the main theoretical approaches employed, (3) the kind of empirical evidence that the researchers produce and present in order to support their findings and the way they analyze the data. Finally we use the concept of humans-with-media (Borba & Villarreal, 2005) to reflect on the possible transformations that online environments produce in the production of research knowledge within this research area. Our study provides an updated overview of the OMTE research area.*

## INTRODUCTION

In his book chapter Schoenfeld (1999) states that the research methods used in educational research are constantly evolving and they may even become obsolete:

To put it starkly, yesterday's tools, techniques, and perspectives are valuable, but they are inadequate to cope with today's challenges, just as today's tools, techniques, and methods will be inadequate in just a few years. (p. 171)

If we look at the evolution of the field mathematics education research, we can see that, indeed, the research methods used in the field have changed (Hart, Smith, Swars, & Smith, 2009) and some of these changes are related to the emergence of new technological tools. For instance, today is possible to use software to develop detailed and comprehensive analysis of qualitative data such as gestures, speech and rhythm (Radford, Bardini & Sabena, 2007), or to study students' conceptions of mathematics through analyses of the photographs taken by mathematics students (Harkness & Stallworth, 2013).

The initial motivation of this work was to explore how technological tools are transforming the work of contemporary researchers in mathematics education. We studied this transformation within an area of research in mathematics education that, by its very nature, takes place in technologized environments. We refer to the research area of online mathematics teacher education [OMTE] (Borba & Llinares, 2012). To explore the possible changes that technological tools produce in researchers' work we use the concept of humans-with-media. This theoretical concept helps to explain how technological tools—and also non-technological media—influence and reorganize the way humans know and produce knowledge (Borba & Villarreal, 2005). Thus, in this paper we analyze, through the concept of humans-with-media, the activity of

researchers working in the area of OMTE; more particularly, we pay attention to the possible transformations that online environments produce in the production of research knowledge.

The meta-study reported in this manuscript is not limited to analyzing possible changes in the work of researchers brought by technological tools; our study also provides a characterization of the emerging research area OMTE. Thus, the purpose of this paper is twofold: (i) to provide a characterization of OMTE research area that focuses on the main topics studied and the theoretical and methodological tools used, (ii) to analyze the research knowledge produced by researchers studying OMTE, paying special attention to the role that technology plays in the production of such knowledge. Our study provides an updated overview of the OMTE research area that can function as a benchmark for future comparisons that could allow us to assess how this research area has evolved.

## RESEARCH QUESTIONS AND METHOD

For practical reasons, to analyze the researchers' work we didn't make direct observations of their activity. We opted instead to analyze empirical studies on OMTE, recently published in international research journals. Our analysis of such empirical studies focused on identifying the main topics studied, the theoretical and methodological tools used, and the type of empirical evidence produced and presented in the manuscripts to support the findings. In particular, the research questions that we addressed in this study are:

- RQ1. What are the main issues investigated in the area of online mathematics teacher education?
- RQ2. What are the main theoretical approaches employed in this area?
- RQ3. What kind of empirical evidence do the researchers produce and present in order to support their findings and claims and how do they analyze the data?
- RQ4. Is the work of the researcher transformed by the characteristics of the online environments? If yes, how?

### Empirical studies reviewed

The literature consulted to develop this study was divided into primary and secondary sources. Next we describe each of these categories.

#### Primary source

The area of OMTE has been characterized as an emerging research area, on which little has been published (Borba & Llinares, 2012). Borba and Llinares (2012) state that a literature search related to e-learning in mathematics education and OMTE in some of the major international journals during the period 2005-2012, produce just a few results. Aware of the scarcity of specialized literature, we decided to start our search in the special issue of the journal *ZDM—The International Journal of Mathematics*

*Education* devoted to the topic of OMTE (volume 44, issue 6) and which brings together researchers from different regions of the world which use different theoretical and methodological approaches in their studies.

### **Secondary sources**

The secondary sources consulted for this study have different origins. On the one hand, we searched on the bibliographic references used in the articles obtained from the primary source. In addition, we consulted three international journals whose aims and scope are directly related to two constitutive elements of the OMTE: mathematics teacher education, and the use of the computers, Internet or other technological resources. The three journals consulted were the *Journal of Mathematics Teacher Education*; *Technology, Knowledge and Learning* (formerly known as *International Journal of Computers for Mathematical Learning*); and *The International Journal for Technology in Mathematics Education*.

It is important to note that all the manuscripts that were selected from the primary and secondary sources for further analysis met the selection criteria described in the next section.

### **Selection criteria for manuscripts**

The manuscripts that were selected for further analysis had to meet the following conditions. First, the manuscripts should report an empirical study in the area of OMTE, these sorts of manuscripts would provide us with relevant information to answer the research questions, particularly RQ3. Second, the articles should have been published recently, more particularly, should have been published during the period 2009-2013. This last requirement allowed us to locate manuscripts that provided us with an updated overview of the state of development of the OMTE.

The above-mentioned selection criteria were applied to the primary and secondary sources for selecting the manuscripts; for example, we selected eight manuscripts out of ten from the primary source. A book review and a research report that doesn't relate to teacher education were excluded. Appendix 1 includes a table showing an overview of the number of articles selected from the primary and secondary bibliographical sources; it also contains the bibliographic details of each of the selected articles. The appendix 1 is available at [http://cor.to/pme\\_OMTE](http://cor.to/pme_OMTE)

### **Analysis of the manuscripts**

Once the eighteen manuscripts listed in appendix 1 were selected, we proceeded to analyze them. To carry out the analysis, some guiding questions were defined. These questions were useful to keep the analysis focused on the aspects of the manuscripts that would allow us to answer the research questions.

To try to homogenize the way the guiding questions were interpreted and applied in the analysis of the manuscripts, there was an initial phase in which all the members of the research team independently applied the guiding questions to 3 of the 18 manuscripts contained in appendix 1. After analyzing the articles independently, the members of

the research team met to compare their results. This stage helped to homogenize the interpretation of the guiding questions and the analysis of the manuscripts. After this stage, the researchers continued examining the manuscripts independently, but meeting regularly to share and discuss their results. The guiding questions used to analyze each of the manuscripts were: (1) what is (are) the research question(s) addressed in the study? (2) what technological tools are used to generate empirical data and what kind of data is generated? (3) what methods are used to analyze the empirical data? (4) what theoretical constructs are used in the study? (5) do you notice any transformation in the work of the researcher(s) conducting the study?

The guiding question (1) was designed to obtain information to answer the research question RQ1. The guiding questions (2), (3) and (4) were used to identify information that could allow us to answer the research question RQ2. Particularly, the guiding question (2) was aimed at investigating the kind of empirical data presented in the reviewed studies, and the role of technological resources in the generation of such data; this information allowed us to answer the research question RQ3. The guiding question number (5) was not focused on identifying a particular type of information contained in the manuscripts, it was used as a question that required us to reflect on the possible changes in the work of researchers as addressed in the research question RQ4.

The answers to the guiding questions connected to each of the analyzed papers were written into tables and categorized. In the next section of the manuscript we present the categorizations constructed, which in turn provide answers to our research questions.

## **RESULTS**

The presentation of our results revolves around four aspects: first, we provide an overview of the main topics that have been investigated in this area; second, we mention the main tools used for the collection of empirical information as well as the theoretical constructs that have been used in these investigations; third, we refer to the type of empirical data used in the studies, as well as the techniques employed to analyze them. Finally, we reflect on an issue that relates to the above three aspects: the possible transformations that online environments may produce on the researchers' work and the type of knowledge they produce.

### **Main issues investigated in the area of OMTE (answer to RQ1)**

The research reports included in this review have a common core feature: all of them focus on aspects of mathematics teachers' knowledge through the use of online environments. The online environment has played different roles in the research reviewed. In most of the studies it has been used as a means to conduct research, but it is also intended as an element that could be incorporated into mathematics teachers' work. Also, some research has focused on phenomena that occur as a result of working with mathematics teachers in online environments.

According to the research interests reflected in the reviewed studies, we have constructed a categorization consisting of two groups that aren't necessarily mutually

exclusive: (a) studies focused on analyzing interactions among teachers in online settings, and (b) studies focused on teachers' professional development.

(a) *Studies focused on analyzing interactions among teachers in online settings*

This kind of studies is conducted with groups of pre-service teachers, in-service teachers, and teacher educators. In these studies online-based interactions among teachers are promoted, and then researchers focus on investigating the specific ways in which teachers communicate and interact in such online collaborative environments. For instance, Silverman (2012) explores the relationship between teacher participation in online discussions and the development of their mathematical content knowledge for teaching. For this, social network analysis methods are employed for coding, comparing and categorizing teachers' participation in online discussions. Schemes such as "Cheerleading/Affirming", "Doing Mathematics" and "Questioning/Challenging" are used for the coding teachers' participation. Subsequently, graphical representations of the interactions among teachers are developed with the help of social network analysis software.

(b) *Studies focused on teachers' professional development*

Mathematics teachers' professional development is a recurrent theme in the literature reviewed. Although there are different interpretations of the concept of professional development in the literature, it is generally understood as changes in the teachers that favor improvements in their professional practice. Some research focuses on investigating how the work and involvement of mathematics teachers in online environments promotes their professional development; for instance, Fernández, Llinares & Valls (2012) study how prospective teachers' participation in on-line discussions when solving specific tasks, supports the development of their capacity of noticing of students' mathematical thinking. Clay, Silverman & Fisher (2012) studied how teachers, after participating in online collaborative work, begin to transform their language incorporating elements of a theoretical approach called Learning Algebra with Meaning; the transformation of teachers' language and its use in analyzing students' mathematical activity, are considered indicators of professional development.

**Main theoretical approaches employed in the area of OMTE (answer to RQ2)**

We found that some of the theoretical approaches used are extrapolations into online environments of theoretical tools originally designed for face-to-face settings; examples of this are the concepts of *community of practice* (used in the study of Kynigos & Kalogeria, 2012) and *mathematical knowledge for teaching* (Clay et al, 2012). However, theoretical approaches originally designed for online or technologized environments are also employed, for instance the concept of *humans-with-media* (see Borba, 2012); there are also methodological tools specifically designed for application to online scenarios such as the model of instruction called *online asynchronous collaboration* and developed by Ellen Clay and Jason Silverman (Clay et al, 2012).

### **Type of empirical data, how are obtained and analyzed (answer to RQ3)**

By empirical data we refer to all kind of data that the researchers have considered as the unit of analysis in their research. Because the research is developed in online settings, the type of data generated is of digital nature; more particularly, the empirical data can be classified as:

*Written productions*: includes interactions in discussion forums, interviews via e-mail, and discussions in chat rooms. For example, in Fernández, Llinares, & Valls (2012) asynchronous forums are analyzed; in such forums teachers discuss the contents of videos of their students solving problems and also students' writing assignments.

*Teaching materials*: in some studies the focus is on the teaching resources designed by mathematics teachers for teaching a particular topic. For example Goos and Geiger (2012) report an study in which prospective teachers are asked to create video presentations along with a set of questions that would engage primary school students in mathematically rich learning. The video material's potential to encourage a critical perspective on mathematics teaching and learning is studied.

*Mathematical productions*: in this category we consider studies that focus on studying teacher-mathematical content relationships. For instance, in Borba and Zulato (2010) the geometric constructions performed by teachers when using a geometry software are analyzed.

The ways in which the data are analyzed are diverse; however, in the review we mainly found qualitative studies. Some of these qualitative studies include quantitative analysis, for example Silverman (2012) made a qualitative categorization of online interactions between teachers, but he also uses social network analysis to quantify such interactions. Another example is the study of Meletiou-Mavrotheris (2012) that includes quantitative data such as the number of messages that emits a participating teacher in an online course. The analysis of teachers' mathematical productions is less common. An example of this is the work of Borba and Zulato (2010) where is analyzed how teachers incorporate a software with graphic capabilities into the process of producing mathematical knowledge.

The main tools used by researchers to generate their empirical data can be graphing software; platform resources such as forums, chat rooms and questionnaires; and digital recording artifacts such as iPods, camcorders, and smartphones.

### **Is the work of the researcher transformed by the characteristics of the online environments? If yes, how? (answer to RQ4)**

The answer to the first question is: yes, through our review we have noticed changes in the work of researchers, which are directly related to the technological tools available in the online environments. To clarify the nature of these changes, we used the concept of *humans-with-media* as a metaphor that "can lead to insights regarding how the production of knowledge itself takes" (Borba & Villarreal, 2005, p. 23); this is, we focused our attention on the unit *researchers-with-online environments* to identify



steps in the production of research knowledge which are transformed by the characteristics of the online environments. In particular we have identified three instances of transformation:

*Access to data.* Online environments allow researchers to access remote data and in a less intrusive manner. With access to remote data we refer to overcoming geographical barriers when retrieving data, for instance, there are studies where online interactions of teachers coming from different geographical regions are analyzed, such is the case of the study of Meletiou-Mavrotheris (2012) involving teachers of statistics from three European countries. We speak of a less intrusive access to data because online environments allow researchers to observe interactions, dialogues, and teachers' mathematical productions without being physically present. This feature provides the researcher with observations that are less intrusive than observations of interactions in a face-to-face setting.

*Data collection and processing.* Online environments may also facilitate and accelerate the collection and processing of data. An example of this is the work of Meletiou-Mavrotheris (2012) where they apply online questionnaires to mathematics teachers and the answers can be quickly captured and processed. In this same study quantitative data on teacher participation in online discussions are used (number of teachers participating in a discussion forum or successfully completing group assignments, number of postings by each participant, etc.), however, these data are automatically generated by the online platform where the discussions take place. This type of data provides researchers with access to features of the interactions and collaboration among teachers that would be difficult to access in face-to-face settings; with these data for instance it is possible to develop detailed studies of interaction patterns within different online discussion groups.

*Adaptation and creation of theoretical tools.* Finally, this review has made us notice that online environments create the need to adapt and create theoretical and methodological constructs adequate to study the didactic phenomena related to OMTE. For instance, Hoyos (2012) refers to the use of the documentational approach to structure teachers' interactions in online asynchronous forums, in order to promote teachers' reflection, however this theoretical approach was initially designed to be applied on face-to-face settings.

## References

- Borba, M. (2012). Humans-with-media and continuing education for mathematics teachers in online environments. *ZDM-The International Journal on Mathematics Education*, 44(6), 801-814.
- Borba, M. C., & Llinares, S. (2012). Online mathematics teacher education: overview of an emergent field of research. *ZDM-The International Journal on Mathematics Education*, 44(6), 697-704.

- Borba, M. C., & Villarreal, M. E. (2005). *Humans-with-media and the reorganization of mathematical thinking: Information and communication technologies, modeling, visualization and experimentation*. New York: Springer.
- Borba, M. C., & Zulatto, R. B. A. (2010). Dialogical education and learning mathematics online from teachers. In R. Leikin & R. Zazkis (Eds.), *Learning through teaching mathematics* (Vol. 5, pp. 111-125). New York: Springer.
- Clay, E., Silverman, J., & Fisher, D. (2012). Unpacking online asynchronous collaboration in mathematics teacher education. *ZDM-The International Journal on Mathematics Education*, 44(6), 761-763.
- Fernández, C., Llinares, S., & Valls, J. (2012). Learning to notice students' mathematical thinking through on-line discussions. *ZDM-The International Journal on Mathematics Education*, 44(6), 747-759.
- Goss, M., & Geiger, V. (2012). Connecting social perspectives on mathematics teacher education in online environments. *ZDM-The International Journal on Mathematics Education*, 44(6), 705-715.
- Harkness, S. S., & Stallworth, J. (2013). Photovoice: Understanding high school females' conceptions of mathematics and learning mathematics. *Educational Studies in Mathematics*, 84(3), 329-347.
- Hart, L. C., Smith, S. Z., Swars, S. L., & Smith, M. E. (2009). An examination of research methods in mathematics education (1995-2005). *Journal of Mixed Methods Research*, 3(1), 26-41.
- Hoyos, V. (2012). Online education for in-service secondary teachers and the incorporation of mathematics technology in the classroom. *ZDM-The International Journal on Mathematics Education*, 44(6), 775-786.
- Kynigos, C., & Kalogeria, E. (2012). Boundary crossing through in-service online mathematics teacher education: The case of scenarios and half-baked microworlds. *ZDM-The International Journal on Mathematics Education*, 44(6), 733-745.
- Meletiou-Mavrotheris, M. (2012). Online communities of practice as vehicles for teacher professional development. In A. A. Juan, M. A. Huertas, S. Trenholm, & C. Steegmann (Eds.), *Teaching mathematics online: Emergent technologies and methodologies* (pp. 142-166). USA: IGI Global.
- Schoenfeld, A. H. (1999). The core, the canon, and the development of research skills: Issues in the preparation of education researchers. In E. Lageman & L. Shulman (Eds.), *Issues in education research: Problems and possibilities* (pp. 166-202). San Francisco, CA: Jossey-Bass.
- Silverman, J. (2012). Exploring the relationship between teachers' prominence in online collaboration and the development of mathematical content knowledge for teaching. *Journal of Technology and Teacher Education*, 20(1), 47-69.

# MATHEMATICAL KNOWLEDGE FOR TEACHING PROBLEM SOLVING: LESSONS FROM LESSON STUDY

Colin Foster, Geoff Wake, Malcolm Swan

School of Education, University of Nottingham

*Although the importance of mathematical problem solving is now widely recognised, relatively little attention has been given to the conceptualisation of mathematical processes such as representing, analysing, interpreting and communicating. The construct of Mathematical Knowledge for Teaching (Hill, Ball & Schilling, 2008) is generally interpreted in terms of mathematical content, and in this paper we describe our initial attempts to broaden MKT to include mathematical process knowledge (MPK) and pedagogical process knowledge (PPK). We draw on data from a problem-solving-focused lesson-study project to highlight and exemplify aspects of the teachers' PPK and the implications of this for our developing conceptualisation of the mathematical knowledge needed for teaching problem solving.*

## INTRODUCTION AND BACKGROUND

There is currently much interest in attempts to describe and measure the kinds of teacher knowledge that underpin the teaching of school mathematics (Rowland, Huckstep & Thwaites, 2005; Hill, Ball & Schilling, 2008). Central to this in the work of Ball and colleagues is the construct of *Mathematical Knowledge for Teaching* (MKT), which is formulated in terms of *mathematical content knowledge* (MCK) and *pedagogical content knowledge* (PCK). There is also a growing awareness of the importance of problem solving in the learning of mathematics (NCTM, 2000) and the need to emphasise mathematical processes such as *representing, analysing, interpreting* and *communicating*. Our attention is, therefore, drawn to how frameworks such as those for MKT ostensibly omit to describe and analyse mathematical *process* knowledge. Even in studies of student knowledge, such as PISA (OECD, 2003), where there is a focus on applications, the mathematical processes often remain implicit rather than explicit.

For instance, we might ask what it looks like for a student to make progress in mathematical communication in a problem-solving context and what pedagogical knowledge would assist a teacher in supporting learners to improve in this. Answers to such questions are necessary to inform the basis of mathematical knowledge for teaching problem solving. A robust conceptualisation of *mathematical process knowledge* (MPK) and *pedagogical process knowledge* (PPK) would assist in supporting mathematics teachers to improve their skills in teaching mathematical problem solving.

MKT is an empirically-derived classification, based on observations of actual teaching. Hence, given our observations that there is a general paucity of teaching of

mathematical problem solving, it is perhaps not surprising that PPK is underemphasised in classroom activity. In this paper, we describe our first steps in interpreting MKT more broadly to include the teaching of mathematical processes as an important part of mathematical activity. We report on a UK lesson-study project involving nine secondary schools (age 11-18) focused on improving the teaching of problem solving in mathematics lessons (Wake, Foster & Swan, 2013). We describe how teachers’ knowledge of processes and students, of processes and teaching, and of processes and the curriculum can be facilitated by a carefully designed lesson-study programme.

## MATHEMATICAL KNOWLEDGE FOR TEACHING

Shulman (1987) precipitated considerable work in the area of knowledge for teaching with his claim that such knowledge is distinct from the content being taught. He outlined seven categories of knowledge for teaching, including pedagogical content knowledge (PCK), which he defined as:

the blending of content and pedagogy into an understanding of how particular topics, problems, or issues are organized, represented, and adapted to the diverse interests and abilities of learners, and presented for instruction. (p. 8)

More recently, Ball and colleagues (Hill, Ball & Schilling, 2008) have developed their construct of *mathematical knowledge for teaching* (MKT), which divides initially into subject matter knowledge and PCK, and then further within these two categories. Other conceptualisations of mathematical pedagogical knowledge, such as the ‘Knowledge Quartet’, due to Rowland, Huckstep and Thwaites (2005), are also framed predominantly around mathematical concepts. Ball and colleagues present their categorisation of MKT as a domain map, and it is fruitful to consider how this diagram looks if we simply replace every occurrence of the word ‘content’ with the words ‘concepts and processes’ (Figure 1). We do not suggest that process and content are dichotomous; on the contrary, we take the view that concepts and processes together constitute the content. We believe, however, that mathematical processes have been relatively neglected, and we seek through our modification of Ball and colleagues’ diagram to place them more prominently within the consciousness of the mathematics education community.

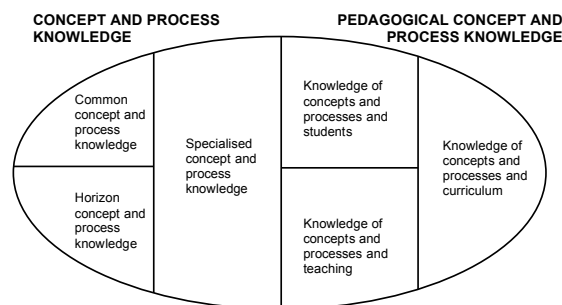

Figure 1: MKT domain map rewritten with ‘concepts and processes’ instead of ‘content’ (adapted from Hill, Ball, & Schilling, 2008)

In order to exemplify and illustrate PPK, we turn now to our case study and our observations of teachers who were participating in a research and development project in which teaching processes was an essential focus.

## CASE STUDY

At the time of writing, we have worked for just over a year with 3-4 teachers at each of nine schools, using a lesson-study model of teacher professional development with a strong focus on mathematical problem solving. Here, a mathematical problem is defined as a task for which a solution method is not known in advance by the solver (NCTM, 2000). A consequence of this definition is that a particular learner's mathematical background is as important as the task itself in determining whether they will experience that task on a particular occasion as 'problematic'. For example, a problem that might be categorised by one learner as a routine exercise in simultaneous linear equations might constitute a mathematical problem for another learner who fails to make that connection or who has no concept of simultaneous linear equations on which to draw.

We adopted a case-study methodology in order to obtain rich, contextual data, which consists of video recordings of the planning meetings, research lessons and post-lesson discussions and audio recordings of interviews with the teachers.

Focusing the lesson-study groups on problem solving added a complexity beyond the 'iconic' Japanese model of lesson study as practised and developed since the nineteenth century (Fernandez & Yoshida, 2004). The participation and support of Japanese colleagues from the IMPULS project at Tokyo Gakugei University ([www.impuls-tgu.org/en/](http://www.impuls-tgu.org/en/)) was critical in bringing their extensive knowledge of the lesson-study process, as well as their interest in learning more about problem solving. On three occasions during the year, experienced Japanese colleagues assisted us in enacting a more authentically Japanese model of lesson study than would have been otherwise possible.

Lesson study involves a community of teachers and 'knowledgeable other(s)' collaborating in a cyclical process that involves planning a 'research lesson', joint observation of the lesson and critical reflection in a detailed post-lesson discussion. This process may lead to the collaborative development of a revised version of the lesson plan and progression once more around the cycle. At the beginning of our project, revising the lesson and re-teaching *as another research lesson* was rare, as the teachers were eager to try a wide variety of different tasks. However, as expertise developed through the project, the desire grew to refine and retry the same lesson in a subsequent research lesson. This paper reports on a problem-solving lesson which was revised and retaught publicly once within the project, although the school also trialled other versions of the same lesson outside the research of the project.

The authors of this paper supported the teachers by joining in the work of the planning team as ideas were developed, and also functioned as 'knowledgeable others' in

post-lesson discussions. A key element of our role was to maintain the focus on problem solving. All of the teachers in our study were adept at planning concept-focused lessons addressing discrete elements of mathematical content: the challenge was to plan lessons centred on the learning of mathematical processes.

## PEDAGOGICAL PROCESS KNOWLEDGE (PPK)

### Planning for the first lesson

The case study reported here focuses on two research lessons that highlighted communication as the key mathematical process. The task ‘Hot under the collar’ (Figure 2a) was adapted from *Bowland Maths* resources ([www.bowlandmaths.org.uk](http://www.bowlandmaths.org.uk)). In its original version, the task attempts to involve all four key processes of representing, analysing, interpreting and evaluating, and communicating and reflecting. In seeking to focus the learning in the research lesson on just one process – communicating – and to take account of a particular class of students, the task was adapted (Figure 2b). The planning team elected to introduce the familiar context of TV weather reporting, with a more experienced weather presenter offering what was previously described as ‘the accurate way’ and the ‘new’ weather presenter opting for the ‘easier method’. The scaffolding of converting 20 Celsius to the Fahrenheit scale using both methods and calculating the error was removed. The question ‘For what temperatures does Anne’s method give an answer that is too high?’ was replaced by the more open question ‘Is Anne’s idea suitable for all situations?’, together with a request to ‘justify your answer and present a convincing argument effectively’. These changes were intended to place the task in a potentially authentic context and to emphasise the communication element.





<p>John and Anne are discussing how they change temperatures in degrees Celsius into degrees Fahrenheit.</p>  <p>John: The accurate way is to: multiply the Celsius figure by 9, then divide by 5, then add 32.</p> <p>Anne: I have an easier method: double the Celsius figure then add 30. That is near enough for most purposes.</p> <ol style="list-style-type: none"> <li>1. If the temperature is 20° C, what would John make this in Fahrenheit? How far out would Anne be?</li> <li>2. For what temperatures does Anne's method give an answer that is too high?</li> </ol>	<p>John is the Senior Weather person at the BBC.</p> <p>Anne is the new Weather Presenter who is due to start work on Monday.</p>  <p>During a meeting on the previous Friday, John tells Anne that to convert from degrees Celsius to degrees Fahrenheit she should divide by 5, multiply by 9 and then add 32.</p> <p>Anne says she is simply going to tell the viewers that you can double the number of degrees Celsius and then add 30.</p> <p>Is Anne's idea suitable for all situations?</p> <p>You must justify your answer and present a convincing argument effectively.</p>  
--	--

Figure 2:(a) Original Bowland task;

(b) Task in first iteration

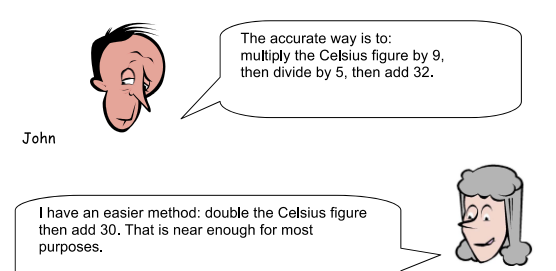
The original task materials included a progression grid for teachers, suggesting what progress in each of the four processes would look like. The planning team adapted this considerably in order to focus on the single process of communication, and organised the grid using the ‘point–evidence–explain’ (PEE) structure commonly used in the UK

in the teaching of English language (DfES, 2005) (Figure 3) to assist students with developing a reasoned argument in their writing.

Communication			
	P <sub>oint</sub>	E <sub>vidence</sub>	E <sub>xplain</sub>
→ Progress →	Their solution indicates a conclusion	Their solution includes evidence to back up their conclusion	Their solution explains their evidence and assumptions
	No conclusion given	Shows some working but it contains errors	No reasoning given
	Their solution indicates a conclusion	Shows working clearly but it contains a few errors	Some reasoning given
	Their solution clearly indicates a conclusion	Shows correct working clearly	Clear reasoning given
	Their solution clearly indicates a more complicated conclusion	Shows working clearly and succinctly	Detailed and clear reasoning given

Communication			
	E <sub>vidence</sub>	E <sub>xplain</sub>	P <sub>oint</sub>
→ Progress →	Their solution includes evidence to back up their conclusion	Their solution explains their evidence and assumptions	Their solution indicates a conclusion
	Shows some evidence but it contains errors	No reasoning given	No conclusion given
	Shows some evidence clearly that helps draw a conclusion. May contain a few errors	Some reasoning given	Their solution indicates a conclusion
	Shows enough clear evidence that helps draw a conclusion	Clear reasoning given and assumptions stated	Their solution clearly indicates a conclusion
	Shows full evidence clearly and succinctly that allows a conclusion to be drawn	Detailed and clear reasoning given. Assumptions are stated and justified	Their solution clearly indicates a more complicated conclusion

Figure 3: PEE grid in (a) first iteration; (b) second iteration

### The first iteration of the lesson

The PEE progression grid was shared with students (Year 10,  $n = 30$ ) at the beginning of the first iteration lesson. Students had encountered PEE in other subject areas, so this structure was not new to them. Pairs of students were given time after working on the problem during the lesson to present their answers on large sheets of paper, and were reminded to use the PEE structure to do this. At the end of the lesson, in a plenary, students compared two pieces of work that the teacher had selected from the class. One of these contained a table of values showing integer temperatures from 1°C to 10°C, with John's and Anne's values for each, along with the difference between them. The other piece of work showed three typical values for each of the four UK seasons and looked at the errors for just these three temperatures. In the ensuing whole-class discussion, the first piece of work was seen to have no explicit conclusion ('point') and the second was considered to be weak in the 'evidence' strand.

### Post-lesson discussion for the first lesson

During the post-lesson discussion, there was much debate about the advantages and disadvantages of PEE as a way of supporting students' development of written mathematical communication. Several participants felt that the order might be changed to make it more appropriate for mathematics and advocated EEP instead, believing that having the 'point' at the end was more in harmony with the practice of mathematical solutions, which tend to culminate in an 'answer'. (There was no consensus on a preferred ordering of 'evidence' and 'explain'.) However, some participants felt that arriving at the answer at the end reflected the experience of *working* on the problem but did not dictate how a final solution might be *presented to others*, where PEE might be clearer for a particular solution and a particular audience. Mathematics students are frequently expected to communicate 'what they are doing' rather than the *outcome* or *conclusion* of what they have done.

It was noted that some students seemed to think that the 'evidence' strand was about quantity – 'the more the better' – and copied out many of the calculations that they had

done. There was little indication in the students' work that they were marshalling evidence *strategically* to support an argument. It was suggested in the post-lesson discussion that effective mathematical communication is assisted by having a clear purpose and audience in mind, so that students know who it is that they need to inform and convince by their argument.

### **The second iteration of the lesson**

Several changes were made to the lesson for its second iteration. The question 'Is Anne's idea suitable for all situations?' in the task was replaced by 'How accurate is Anne's approximation?' In the first case, a student could answer that it is only 'suitable' on one occasion (10°C, where the two Fahrenheit values obtained are identical), whereas the second version was intended to force students to focus on accuracy, potentially leading to very different communications, particularly in students' explanations.

The other big change to the lesson was to modify the PEE structure to revise the order to evidence-explain-point (EEP). The statements of progression for evidence were also modified so as to tighten the link between 'evidence' and its purpose in supporting a conclusion, in order to attempt to combat the 'more evidence the better' problem seen in the first lesson.

### **Post-lesson discussion for the second lesson**

Participants discussed the advantages and disadvantages of a generic PEE or EEP scheme and whether a structure perhaps needed to be adapted to the details of each particular task. No consensus was reached on these matters, but the view was expressed that the preferred order might depend on whether the intention is to communicate working or conclusions.

## **DISCUSSION**

We now briefly describe and exemplify three elements of pedagogical process knowledge (PPK) observed during the course of this iterative lesson-study cycle.

### **Teachers' knowledge of processes and students (KPS)**

By analogy with Ball and colleagues' (2008) 'knowledge of content and students', we see KPS as the intertwining of knowledge of processes and common ways in which students think about processes, what contexts motivate them to learn the processes and what difficulties they have. We found that students frequently interpret requests for mathematical communication as invitations to 'show working' – the more the better – and fail to attend sufficiently to purpose and audience. The frequently reiterated demands of examination technique (so-called 'quality of written communication') may at times conflict with those of clear and meaningful communication of a reasoned mathematical argument.



### **Teachers' knowledge of processes and teaching (KPT)**

We see KPT as relating to knowing and being able to use effective strategies for teaching problem-solving processes. The debate over the virtues of PEE versus EEP as a scaffold for developing mathematical communication is a good example of the sort of thinking that lies within this domain. We found that this aspect of MKT for problem solving is particularly underdeveloped in the teachers with whom we have worked in our project.

### **Teachers' knowledge of processes and the curriculum (KPC)**

We see KPC as knowledge that enables teachers to select and sequence suitable tasks to facilitate a coherent development in students' process skills. The idea of designing a sequence of lessons to develop a single process, such as communication, represents a certain kind of KPC, as does choosing tasks which provide suitable opportunities for specific process learning. Moving beyond this to develop a coherent, sustained approach to the learning of problem solving over time provides a challenge beyond the scope of our work to date.

Watson (2008) warns that identifying types of knowledge can be unhelpful and lead to a fragmentary sense of what is relevant. Various attempts at schematising the mathematical problem-solving process, such as RUCSAC (read, understand, choose, solve, answer, check) ([www.tes.co.uk/ResourceDetail.aspx?storyCode=3007537](http://www.tes.co.uk/ResourceDetail.aspx?storyCode=3007537)), are widely thought to detract from the authentic experience of problem solving. Does PEE/EEP perhaps come into this category? Student mathematical actions are driven by the task and inevitably require them to draw on concepts as well as processes following their individual understanding of the context. Coherent mathematical activity requires a subtle blending of engagement with mathematical content, mathematical competencies and context (Wake, 2014). Consequently, we believe that it is important to recognise the interdependency of content, context and processes.

## **CONCLUSION**

In conclusion, we are not surprised that an empirical approach to the conceptualisation of MKT has not so far identified knowledge of mathematical processes as fundamental to everyday classroom practice. We know that problem solving is often not given the attention it deserves in day-to-day teaching. Teachers' understanding of process skills and what it means to make progress in learning processes is currently significantly underdeveloped.

Mathematical communication is widely seen as an important component of doing and learning school mathematics (Sfard, 2007), yet the mathematical processes are approached quite differently from processes in other subject areas. For example, the teaching of 'native language' in England works to a very different epistemological frame that prioritises how English is used in practice rather than knowledge to be assimilated.

In this paper, we have drawn on our findings to suggest aspects of PPK that might be given greater attention. In subsequent work we seek to extend our characterisations and develop the conceptualisation of MKT to emphasise further the mathematical practices in problem solving.

### Acknowledgements

The research that informed this paper was funded by the Bowland Charitable Trust ([www.bowland.org.uk](http://www.bowland.org.uk)). We would like to thank all of the teachers involved for their participation and their many insights, and particularly our Japanese colleagues from the IMPULS project at Tokyo Gakugei University ([www.impuls-tgu.org/en/](http://www.impuls-tgu.org/en/)).

### References

- DfES. (2005). *Key stage 3 national strategy. Leading in learning: Exemplification in English*. London: DfES.
- Fernandez, C., & Yoshida, M. (2004). *Lesson study: A Japanese approach to improving mathematics teaching and learning*. Mahwah, NJ: Lawrence Erlbaum Associates.
- Hill, H. C., Ball, D. L., & Schilling, S. G. (2008). Unpacking pedagogical content knowledge: Conceptualizing and measuring teachers' topic-specific knowledge of students. *Journal for Research in Mathematics Education*, 39(4), 372-400.
- National Council of Teachers of Mathematics (NCTM). (2000). *Principles and standards for school mathematics*. Reston, VA: NCTM.
- OECD (Organisation for Economic Co-operation and Development). (2003). *The PISA 2003 assessment framework – Mathematics, reading, science and problem solving knowledge and skills*. Paris: OECD.
- Rowland, T., Huckstep, P., & Thwaites, A. (2005). Elementary teachers' mathematics subject knowledge: The knowledge quartet and the case of Naomi. *Journal of Mathematics Teacher Education*, 8(3), 255-281.
- Sfard, A. (2007). *Commognition: Thinking as communicating: The case of mathematics*. Cambridge: Cambridge University Press.
- Shulman, L. S. (1987). Knowledge and teaching: Foundations of the new reform. *Harvard Educational Review*, 57(1), 1-23.
- Wake, G. (2014). Making sense of and with mathematics: The interface between academic mathematics and mathematics in practice. *Educational Studies in Mathematics*. doi: 10.1007/s10649-014-9540-8
- Wake, G., Foster, C., & Swan, M. (2013). A theoretical lens on lesson study: Professional learning across boundaries. In A. M. Lindmeier & A. Heinze (Eds.), *Proc. 37<sup>th</sup> Conf. of the Int. Group for the Psychology of Mathematics Education* (Vol. 4, pp. 369-376). Kiel, Germany: PME.
- Watson, A. (2008). *Developing and deepening mathematical knowledge in teaching: Being and knowing*. Paper presented at MKiT 6, Nuffield Seminar Series, University of Loughborough, UK. Retrieved from [www.maths-ed.org.uk/mkit/MKiT5\\_Watson\\_distribution-version.pdf](http://www.maths-ed.org.uk/mkit/MKiT5_Watson_distribution-version.pdf)

# JAMILA'S STORY: ANALYSING AFFECTIVE BEHAVIORS THROUGH A PRAGMATIST PERSPECTIVE OF IDENTITY

Cristina Frade<sup>1\*</sup>, Stephen Lerman<sup>2</sup>, Luciano Meira<sup>3</sup>

<sup>1</sup>Federal University of Minas Gerais, <sup>2</sup>Loughborough University

<sup>3</sup>Federal University of Pernambuco

*This paper presents the story of a novice mathematics teacher, through which we aim to explore the social nature of affective behaviours drawing on a pragmatist perspective of identity formation. Data was produced by interview and treated as narrative, allowing the teacher-participant to freely trace and trace back contextually relevant aspects of her/his life experience. Our analysis indicates that teachers' affective positionings towards others emerge from shared social scenarios, manifested in response/reaction to such scenarios, and reflect their attempts to redescribe themselves in the eyes of others.*

## INTRODUCTION

Over the last ten years, the interest in studies about identity in the context of mathematics teachers' professional development has increased significantly. Walshaw (2004), for example, investigated the power of subjectivity over pre-service students' engagement when they were involved in pedagogical tasks in the first years of primary school mathematics classrooms. Brown & McNamara (2011) approached the development of mathematics teachers' formation and the construction of their professional identities, considering the implications of these processes in their teaching. Taking a sociological perspective, Lerman (2012) showed that individuals who have taken up mathematics as their careers were able to exhibit agency and change the direction of their lives in spite of what might be described as disadvantaged social backgrounds. The collection of articles edited by Frade, Roesken & Hannula (2010) proposed that both affect and identity may be seen as emerging individually through personal experiences, or as emerging socially through shared scenarios, and that this tension became salient when relationships between affect and identity were explored regarding the mathematics teachers' professional development. A common point in all these studies is the idea of bridging between the individual and the social.

Our study is situated within perspectives on the social nature of affective behaviors and the constitution of teachers' identities. Using a pragmatist perspective on identity formation, we suggest that the search for "bridges" between the individual and the social for approaching affect and the constitution of identity is not fruitful. The way in which we interpreted the theoretical perspectives we adopt led us to reject any "divorce" between the so called 'individual realm' and 'social context', since the

---

\* Supported by CAPES and CNPq.

individual and the social are relational entities articulated as a unity in semiotic interactions. Next we detail our ideas aiming at presenting our research questions more clearly.

## A PRAGMATIST PERSPECTIVE ON IDENTITY FORMATION

Like many other researchers (e.g., Damasio, 2003), we believe that human beings are born with biological mechanisms dedicated to learning. However, the developing person requires radical changes from biological determination to semiotic interaction with others-in-the-world. We suggest that what we call affect, or affective positionings toward others, emerges at the forefront of our identity formation. This depends on learning processes that begin as actions towards social scenarios and later in development become responses to individual/private demands. This is akin to Vygotsky's (Vygotsky & Rieber, 1998) second law of development, according to which all forms of knowing move from social settings to individual persons, and then from the individual to the social, in a constant semiotic interaction among individuals and, more generally, between individuals and their historical socio-cultural contexts. As such interactions emerge in life, all forms of knowing/learning (including our affective positioning towards others) are internalized and contribute to individuals' identity formation. We observe that such internalization is not passive. It instead involves a complex combination of contingency, circumstance, choice and judgment. In this sense, one's identity is only temporally stable; it is continually changing and dependent on the historical socio-cultural contexts to which individuals respond.

For pragmatist scholars (e.g., Dewey, 1916; Rorty, 1989), there is no core human essence or an innate self previous to semiotic interactions between individuals and their action-contexts. Hytten (1995) noted that

[Dewey] argues that individual minds are developed through social intercourse, that humans are characterized by their plasticity, which ensures the possibility of continual growth and that autonomy results from individual redirection, reconstruction and revision of societal understandings and beliefs. (p. 2)

The quotation above strongly suggests that identity formation is a process of self creation in response to social scenarios (some of which may well be private) and continual growth. Along the same lines, Rorty (1989) introduced a notion of identity that shifts the emphasis from an internal self/mind to language, suggesting that "no core essence or identity exists which lies behind the language individuals use to describe themselves and their world" (Hytten, 1995, p. 2). This notion of identity is developed by Rorty on the basis of two key ideas: blind impresses and final vocabulary. By 'final vocabulary' Rorty meant the set of words used by any one individual to justify her/his actions, beliefs/convictions and life; words with which we narrate the story of our (past and prospective) lives. For Rorty, the vocabulary is "final" in the sense that its words make up the boundaries of the stories we can tell about ourselves at a certain stage in life. On the other hand, 'blind impresses' are those

particular contingencies that make each of us unique and not a copy or replica of some other person; they guide our conduct and more generally our discourse.

In terms of culture, we interpret Rorty's ideas as follows: while we live in a cultural context, which we grow up and structures our world view, we are unaware or “blind” to some differences (gender, religion, race,...), as a fish is unaware that it lives in water. When we step out of this context, and begin to recognise other cultural contexts or differences, our blind impresses are no longer blind because this recognition implies in a redescription (a process of confronting our own contingencies and to trace our idiosyncrasies backwards and forwards, as Rorty puts it) of ourselves by developing a new language. Thus, by tracing our blind impresses in our own discursive moves, we continuously reinvent ourselves. Having said this, we argue that people develop, share and negotiate their identities in semiotic spaces by communicating selected aspects of what they think to be their blind impresses through some kind of final vocabulary. We believe this to be precisely what Gee (2000, p. 99) meant by "all people have multiple identities connected not to their 'internal states', but to their performances in society".

Based on the premises above, we wanted to investigate how to make sense of the manifestations of teachers' affective positionings towards others, from the point of view of the pragmatist perspective of the constitution of identity. How do such positionings emerge, and how are they produced, communicated and negotiated towards the formation of one's identity as a mathematics teacher? Our proposal is then to explore affective conducts through the notion of identity.

To offer a response to our research questions, we carried out an empirical investigation with two categories of secondary mathematics teachers (twelve teachers in total): one represented by teachers in their first four years of professional experience, and the other, with more than seven years of career. This choice was due to a conjecture that teachers of the first category were still positioned very close to the boundary crossing between their professional projections—socially constructed through their experiences of life (including the university formation) – and the effective practice of being a teacher. Therefore they are in an affective positioning potentially fruitful for capturing possible redirections or redescrptions of their blind impresses to survive in the profession. For the second category, our conjecture was that these redirections or redescrptions stabilize somehow during the practice. In this case, we would observe how this stability occurs.

## **METHODOLOGY**

Our research demanded a qualitative/interpretative approach, in order to promote an immersive analysis in the stories, life experiences and feelings that make up one's identity. Further, the theoretical frameworks we adopted—the social nature of affective behaviors, according to Vygotsky's second law of development, and a pragmatist perspective for the constitution of identity—imply, as noted by Meira (2006), in “a conception of development and learning as emergent semiotic processes in daily contexts of human experience” (p. 11). In this respect, we tried to follow Halliday's

(1993) suggestion that data should be ‘natural’ (not experimental): based on language, not self-monitored, in the context of its production, and not dissociated from the circumstances. We understand that interviews-in depth, semi-structured in a flexible way, matched (at least in part) the above point of view. The intention was to welcome both retrospective and prospective speeches, allowing the interviewee to trace and trace back in time the various phases of the projection they made in relation to a certain situation, showing that the discourses are not dissociated from the context of their production and enunciation. In this sort of interview, the interviewees are asked to talk about some few key aspects of the theme of research, giving them the maximum of freedom to treat the subject flexibly. We cannot but be aware that the interview situation is itself a productive context, in that the interviewee presents her/his as she/he wants to be seen and heard to that person at that moment.

We interviewed four teachers (3 females and 1 male) in Belo Horizonte, Brazil, and eight teachers (5 females and 3 males) in London, UK. Regarding the Brazilian teachers, two had recently finished their doctoral course in mathematics education, and one was in the middle of his doctoral research. The eight teachers from London were also students-teachers of a mathematics education undergraduate course. Among them, six were immigrants or originated from immigrant families from different countries. The interviews varied from 20 to 75 minutes each, and were audio-recorded. We also made use of personal notes. The first author started from the initial orientation “Please, talk about why did you want to be a mathematics teacher”. Next, she asked them to talk about their expectations in being a teacher and their real experiences as teachers. Then she asked them to talk about the flexibility of their schools regarding modes of teaching, and if they had experienced any special (conflicting or pleasant) moment in teaching they would like to report. We looked at the teachers’ reports as narratives and analysed them as such. By narrative we are referring to a discursive instrument of construction of the past, present and prospective reality of an individual. For Bruner (1987), thanks to the cultural systems of interpretation, coded in the form of narrative, the conversations about the past and the future make one’s own life more comprehensible.

Next we discuss some data to illustrate our ideas. In order to present in detail our ways into the analysis, we present the story of only one teacher-participant: Jamila, fictitious name of a representative of the first category of novice teachers. We chose to report on Jamila's story because her professional choice for teaching mathematics was the only one that proved to be influenced by political circumstances. This story was constructed from Jamila’s narrative. Her words are in italics and have not been corrected for the English. Our comments are in brackets.

### **JAMILA’S STORY**

At the time of the interview, Jamila was 49 years old. She was born and gained her graduation in mathematics in Hungary. In 1997, she moved to London because she married a British citizen. Jamila indicated that her professional mathematical identity

has emerged in the context of Hungarian communism, from a combination of three main affective positionings towards: a familial affinity; a political belief about mathematics as culture and value-free; and a sentiment of “defence” against the regime. She said:

I came from a long line of teachers in my family, and some of them are from humanities, like as linguistics, history, and some of them are from physics and mathematics (...) I chose mathematics because mathematics couldn't be distorted by the regime. Mathematics was clear and straightforward. We're not telling in a sense our opinion; you are solving problem, and you had an answer to it (...) No matter which field you came from, when you solve the mathematical problems that is a very international thing and then politics and ideology couldn't be involved in that (...) and nobody could say 'No, that is not right because today in this country we don't think like that'. So, I chose because of that, so it's a political reason.

The passage above shows two special things: the decisive role played by Jarmila's affective positionings in the forefront of her professional identity formation; and how this identity formation was constituted by the social circumstances she was subjected to in a certain period of her life. Regarding the familial positioning, Jamila gave strong indications that it was produced by affinity since almost everybody in her family was a teacher. She stated that “*it was almost obvious to [her] to become a teacher as well [because she] didn't know anything [than being a teacher]*”. It is possible that her stance towards mathematics as supposedly an apolitical discipline had been produced by the influence of her mathematician relatives, and then reinforced in the university graduation course, including her experience in the teaching practice in a selective school with high achieving students. She did not mention any personal or special appreciation for mathematics in itself nor if she experienced, at that time, any type of conflict between her expectation in being a mathematics teacher and her experience in the teaching practice. It is also possible that, up to that time, Jamila's professional mathematical identity had a certain stability. However, she suggested that this possible stability was disturbed when she had to step out of the culture in which she grew up and structured her world view, and became aware that the selected environment of her teaching practice in Hungary was not representative of every place—her blind impressions regarding her teaching experience in Hungary were no longer blind when she was faced with differences. We can see this in the following:

Before I came to this university [in London] I taught for two years in a small independent school (...) with the kind of approach that children have to experience what they do (...) What the funny thing is that in Hungary you do your teaching practice in selected schools (...) you don't meet behaviour problems, you don't meet children who will find difficulty to understand a concept because they all came from a background that was established (...) you put together your lesson plan and then you're going to the class and you carry it out. And then when you go out and meet the real children, well that's completely different experience (...) When you're going to the real life then we will find that (...) children (...) may not have the concept established, they would come from all different backgrounds (...) and then, your lesson is not going to happen according to your lesson plan at all.

This new social scenario touched Jamila, and provoked the emergence of new affective positionings towards her students and modes of teaching, including the enlargement of her final vocabulary as teacher. In an attempt to adapt to this new scenario, she decided to convert her diploma, gained in Hungary, doing a PGCE course [Postgraduate Certificate of Education] in a public university in London. Feelings of sensibility and cooperation were produced due to her desire to attend to her students' needs, differences, backgrounds, and past experiences. And these demanded a redescription of Jamila as she explained in the passage:

This [new scenario] becomes me more flexible, and sometimes I decide just put the lesson plan completely aside, and let us do something, just sit down to discuss and see what we have got together as a class (...) What I learn through this is that you must be flexible with your lessons (...) it made me listen much more, a little bit of the past of the class, working together, trying together to achieve something.

Further, she said her participation in the PGCE course, notably interacting with her young colleagues helped her to carry out this redescription to make things less difficult for her. She developed an affective positioning towards her colleagues saying that she *“learn[ed] a lot from them (...) value[d] their company”*. For her, they were *“a group”*, and *“very often [she] just listen[ed] and tr[ied] to make sense where to put [her]self”*. Jamila clarified in what sense she has been benefiting from her colleagues:

The world has changed, the children are more open and in a sense they expect less authority, which can be a good thing because that means that it has become more democratic. They expect you to listen and value their opinion, but I have to learn that new approach because when I finished studying in maths becoming a teacher was completely different.

At the time she was doing the PGCE course, Jamila started teaching in another secondary school, and this experience led her to give continuity to the development of other types of affective positionings towards her students, the school and modes of teaching. She reported that this school was *“an extraordinary, selective, independent Muslim school just for girls (...) odd than the ordinary”*, and that [she kept] *it approach, that is, that the class have to work together, and then [she and the students] ha[d] to achieve something together (...)* She stated she was very encouraged to be in an environment like that, and suggested that her affective positioning towards the students has changed because now she was in an environment that *“girls [were] very kind and helpful, they enjoy[ed] helping each other”*. Here, again, we have evidence that such affective positionings emerged from a social scenario and were produced in response to it, as reinforced by Jamila:

When I go to the school with these girls, it's great to go into the classroom and then have luck in all work, and by the end of lessons they says they discovered something (...) I can become very touched, children can touch me. In one of the classes there is this girl who, her sight is very bad so we have to prepare for her, and seeing her how happy she is when she keeps up with the class and achieve the same things the class can do.



When she said “*to prepare for her*”, can this be a clue that, among other actions, Jamila’s impressions regarding her prototype of ‘student’ has changed and because of this she had to enlarge aspects of her final vocabulary as teacher to communicate with this girl?

Jamila also showed she has developed a healthy relationship with her mentor, but found it hard to redescribe herself as aiming at reaching a “*fine balance*” between the school and parents’ expectations and her identity as mathematics a teacher. She explained this conflicting negotiation in this way:

My mentor, she is an experienced teacher (...) she says she is open [to] new ideas (...) and she says the way she could do use me: this school is a high achieving school, so, for that reason, you have to make sure whatever you teach, in the end, the girls are going to able to complete GCSE [General Certificate of Secondary Education] on a very high level and that comes first. It’s very hard because the schools have their expectations, so it’s not that you come with bright ideas and would like to carry them out, but the school is going to say ‘No, listen, this is the way we do things here, and we don’t mind if you experience a little bit harder, we would like to carry on a method because it is a tried method that works with us’.

Despite all these, Jamila seemed very aware of the need to redescribe her actions in response to social institutional demands saying that:

It doesn’t only depend on me what sort of teacher I am going to be, what sort of the teacher’s personality I am going to be, that is more or less on me, but sort of a teacher convey the subject is not only than to me (...) We have to adapt.

## FINAL COMMENTS

In a previous work (Frade, Roesken, & Hannula, 2010), we suggested how conflicting the processes of identity formation in novice mathematics teachers may become, especially those dominated by conflicts involving strong projections of what a “good teacher” is expected to be and to do. Jamila’s discourse showed how difficult it is being Jamila in everyday school practice; how it is conflicting to combine a redescription of herself in the eyes of others (students, mentor, institution) with her own demands towards herself. In spite of this, she seemed to have developed a way to deal with all these, perhaps an emotional maturity in recognizing that she needs to find a balance between the institutional demands and her own demands to adapt to and to survive in the profession. And this possible emotional maturity seems to be what can be said that stabilizes along the professional practice of being a teacher. The continuing redescrptions that characterize the constitution of one’s identity as teacher, as discussed in our previous work and demonstrated in Jamila’s story, led us to say that affective positionings towards others are strongly ‘situated’ in that they emerge from temporal-specific social scenarios, and are learned, produced, communicated and negotiated as responses/reactions to it. In this sense, the pragmatist perspective we used is very helpful, for it directs our analysis to “outward rather than inward, toward the social context of justification rather than to the relations between inner representations”. (Rorty 1979, p. 424) Jamila’s story aimed at showing that for each

scenario she was subjected to—the familial context, the political circumstances of the two countries involved, the different schools she taught at, and the PGCE course, for instance—were sources of the origin of both affective positionings towards others and ruptures of some of her blind impresses regarding the career of mathematics teacher. On the other hand, such affective positionings reflected Jamila’s attempts to redescribe herself towards a new Jamila in the eyes of these others by developing a new language to better ‘live’ in such scenarios.

## References

- Brown, T., & McNamara, O. (2011). *Becoming a mathematics teacher: Identity and identifications*. London: Springer.
- Bruner, J. (1987). Life as narrative. *Social Research*, 54(1), 11-32.
- Damasio, A. (2003). *Looking for Spinoza: Joy, sorrow and the feeling brain*. New York: Harcourt.
- Dewey, J. (1916). *Democracy and education*. New York: The Free Press.
- Frade, C., Roesken, B., & Hannula, M. (2010). Identity and affect in the context of teachers’ professional development. In M. M. F. Pinto & T. F. Kawasaki (Eds.), *Proc. 34<sup>th</sup> Conf. of the Int. Group for the Psychology of Mathematics Education* (Vol. 1, pp. 247-279). Belo Horizonte, Brazil: PME.
- Gee, J. P. (2000) Identity as an analytic lens for research in education. *Review of Research in Education*, 25, 99-125.
- Halliday, M. A. K. (1993). Towards a language-based theory of learning. *Linguistics and Education*, 5, 93-116.
- Hyttén, K. (1995). *Identity, plurality and education - a pragmatist complement. philosophy of education*. Retrieved from [http://education.illinois.edu/EPSPES-Yearbook/95\\_docs/hyttén.html](http://education.illinois.edu/EPSPES-Yearbook/95_docs/hyttén.html), 25/12/2009)
- Lerman, S. (2012). Agency and identity: Mathematics teachers’ stories of overcoming disadvantage. In T.-Y. Tso (Ed.), *Proc. 36<sup>th</sup> Conf. of the Int. Group for the Psychology of Mathematics Education* (Vol. 3, pp. 99-106). Taipei, Taiwan: PME.
- Meira, L. (2006). *Produção de sentidos na zona de desenvolvimento proximal – Teoria e método numa proposta de inspiração pragmatista*. Projeto submetido ao CNPq para renovação da bolsa de produtividade PQ 2007-2010.
- Rorty, R. (1979). *Philosophy and the mirror of nature*. Princeton: Princeton University Press.
- Rorty, R. (1989). *Contingency, irony, and solidarity*. Cambridge: Cambridge University Press.
- Vygotsky, L. S. (1998). Pedology of the adolescent [selected chapters]. In R. W. Rieber (Ed.), *The collected works of L. S. Vygotsky. Volume 5: Child psychology* (pp. 31-184). (M. J. Hall, Trans.). New York: Plenum.
- Walshaw, M. (2004). Pre-service mathematics teaching in the context of schools: An exploration into the constitutions of identity. *Journal of Mathematics Teacher Education*, 7, 63-86.

# WHAT DID THE STUDENTS LEARN FROM MATHEMATICS TEXTBOOKS? THE CASE OF L. F. MAGNITSKII'S *ARITHMETIC*

Viktor Freiman<sup>1</sup>, Alexei Volkov<sup>2</sup>

<sup>1</sup>University of Moncton, Canada

<sup>2</sup>National Tsing Hua University, Taiwan

*In this paper, we investigate the Arithmetic authored by L.F. Magnitskii (1669-1739) especially focusing on the methods of teaching and learning represented in this arithmetical manual that remained highly influential among the Russian educators for more than a century after its publication in 1703. We suggest that Magnitskii, even though drawing upon arithmetical manuals published in Western Europe in the 17th century, introduced a number of new elements that can be properly interpreted only if one takes into consideration his didactical agenda.*

## HISTORICAL AND SOCIOCULTURAL PERSPECTIVE

When conducting research on the history of mathematics education, the historians usually work with the extant documents they have at their disposal, especially the mathematical textbooks or other written materials used for instruction. However, as Michael Polanyi (1891 – 1976) argued in his seminal work of 1958, in the process of transmission of scientific knowledge its considerable part is not verbalized; a substantial part of knowledge is transmitted via direct interaction between the individuals involved. If we adopt his hypothesis, the materials found in modern mathematics textbooks cannot suffice to reconstruct the actual interaction between teachers and learners who use these textbooks nowadays, and additional methods (e.g., classroom observation, interviews, etc) are needed to discern and analyse the processes of learning. However, when dealing with the history of mathematics education, the classroom observations and interviews, for obvious reasons, are impossible to conduct, and alternative research methodologies have to be designed to reconstruct, at least partly, the processes of instruction on the basis of the extant written materials.

This paper is focused on the tradition of mathematics education in Russia, in particular, on the first printed school mathematics manual, the *Arithmetic, or Science of Numbers* (Арифметика, сиречь наука числительная) published by L.F. Magnitskii's (Л. Ф. Магницкий, 1669-1739) in 1703. The conventional descriptions of mathematics education in Russia have always been based upon the extant textbooks of which the first ones were compiled during the period antedating the publication of Magnitskii's manual (see, for example, Yushkevich 1968), yet no historiography of Russian mathematics education that would take into consideration the role of tacit knowledge in educational practices, to the best of our knowledge, has ever been published.

It appears plausible to distinguish two types of "tacit knowledge". The first type is directly related to the subject matter of mathematics instruction, in other words, it

comprises conceptions (and sometimes misconceptions) concerning numbers, figures, and other mathematical objects, as well as operations with them. The second type is related to didactical aspects of instruction, in particular, to the style of interaction between the teachers and learners. This type is determined by a more general framework which, in turn, is related to the traditions of teaching and learning specific for the respective social group and for the embracing cultural tradition. In our case, we are dealing with the traditions of teaching and learning which existed in Russia some time before the publication of Magnitskii's textbook and which, arguably, continued to exist after it. These two types of tacit knowledge can be identified as ideas, concepts, and representations concerning, on the one hand, the contents of the respective discipline (in our case, elementary mathematics), and on the other, the processes of its transmission which were not verbalized or at least were not described explicitly in the extant materials.

We therefore assume that the mathematical knowledge represented in the *Arithmetic*, even though based upon Western textbooks originating from a different educational tradition, was adjusted by Magnitskii to fit into the classroom activities different from those taking place in the Western classroom. In other words, we can interpret the modifications of Western teaching materials (mathematical problems, definitions of mathematical objects) made by Magnitskii in his textbook as resulting from requirements (tacitly) imposed by the Russian didactical tradition that differed from those of Western Europe. The sources of information used for our reconstruction of the Russian didactical practices are: (1) the elements found in Magnitskii's *Arithmetic* and other Russian textbooks which distinguished them from their (hypothetical) Western prototypes and which cannot be explained as caused by purely mathematical or linguistic reasons, and (2) the practices adopted in Russian/Soviet schooling tradition in the 19<sup>th</sup> and 20<sup>th</sup> centuries that have been, at least partly, documented.

Paradoxically, we will begin our study of the Magnitskii's textbook with a discussion of the case of "Asian/Confucian learners". Recently a considerable number of publications were devoted to the phenomenon of Chinese mathematics education; the difference with the learners from other countries (in particular, from the USA) was perceived, but not always clearly stated or identified. The path-breaking monograph of Ma Liping (1999) was followed by a large number of studies of Chinese mathematics classroom, and these studies, including the book of Ma, contain an amount of data concerning the second kind of abovementioned tacit knowledge, such as detailed descriptions of Chinese methods of learning, teaching etc. From North-American perspective some of the Chinese didactical approaches may be seen as somewhat exotic and/or inapplicable in American/Western classroom (for example, memorization of multiplication table), yet for the Chinese educators and students such practices, especially memorization, look highly relevant.

The phenomenon of "Chinese mathematics education" became famous mainly due to the success of Chinese students in various kinds of competition and comparative studies, but in reality the transfer of Western mathematical knowledge and, to some

extent, Western teaching practices to China happened relatively late, in the late 19th century, even though some attempts were made in the 17<sup>th</sup> and early 18<sup>th</sup> centuries, but without particular success. Technically, “Westernized” Russian mathematical tradition that started some time prior to the publication of Magnitskii’s textbook had a much longer history and was much more developed, but due to the fall of the USSR and economical success of China, the attention of the researchers turned to China, even though a number of recent publications were devoted to the phenomenon of Russian and Soviet mathematics education (see, for instance, Karp and Vogeli 2010; 2011).

A number of attempts have been made to explain the success of Chinese mathematics learners; for example, a number of authors suggested that it resulted from a particular “Confucian” cultural tradition of teaching and learning, while some other authors expressed their doubts concerning this thesis (see, for example, Leung 2001; Fan et al. 2004); see also the analysis of the philosophical foundations of Chinese and American systems of mathematics education by Xie and Carspecken (2008) and a comparison of European and Chinese “cognitive styles” and their impact on teaching mathematics (Spagnolo and Di Paola 2010). Conversely to the case of Chinese mathematics education, the case of USSR/Russia remains largely underexplored. The innovations introduced by Russian educators were not duly documented, and the remaining documents often do not provide information necessary for reconstruction of educational activities. The study of Magnitskii’s textbook was not an exception: a number of historians of mathematics and mathematics education, when dealing with the *Arithmetic*, did not pay enough attention to the didactical techniques found in this book.

## DIDACTICAL PERSPECTIVE

We will open this section with a short presentation of the studies devoted to the *Arithmetic*. To identify the “tacit” didactical elements in Magnitskii’s textbook, we will compare its contents with those of its hypothetical Western prototypes in assuming that the found differences resulted from the didactical agenda of Magnitskii.

According to A. Vucinich, “In the seventeenth century – the century of logarithms, analytical geometry, and calculus – Russia’s mathematical knowledge did not exceed the most elementary principles of arithmetic contained in the translations of Western European (mainly German) texts written during the fifteenth and sixteenth centuries”. (Vucinich 1963, p. 33) Therefore, according to the latter author, “the *Arithmetic* was important not only in bringing up-to-date elementary mathematical knowledge to Russia but also in showing the wide range of practical problems – particularly of a military and commercial nature – that could be solved mathematically” (ibid., p. 54). Moreover, based on Peter the Great’s dedication to the program of strengthening the nation that required from the emerging new Russian ruling class excellent command of several foreign languages, knowledge of rhetoric as well as of the arts of philosophy, medicine and theology, Magnitskii claimed in the preface of his book that “not only is arithmetic essential to education in the liberal arts, but the practical skills of measuring

and counting were needed by a dynamic society as well” (Okenfuss 1995, p. 75). When mentioning that Magnitskii wrote his book as a “humanist, concerned above all with the place of mathematics in the mind of an educated man,” Okenfuss argues that his work was a “culmination of the impact of the foreign on seventeenth-century Muscovy” (ibid.), thus defining the direction of development of mathematics in Russia for the next half of the century.

The recognition of the didactical value of Magnitskii’s work came only a century later when it became one of the central topics in the framework of historical reconstruction of the growth of mathematical knowledge in Russia in the beginning of the 18th century of which Magnitskii’s *Arithmetic* was considered an important milestone (Vulcinich, 1963). The significance of the *Arithmetic* for the formation and evolution of mathematical education in Russia was especially emphasized in the 19th century by the historian and educator V. Bobynin (В. В. БОБЫНИН, 1849-1919), who considered it a link between the Russian mathematical texts of the 17<sup>th</sup> and the 18<sup>th</sup> centuries, while also serving as an introduction to novel mathematical subjects (e.g., progressions, algebra, etc.) not included in manuscript textbooks that circulated in Russia prior to its publication or were only rarely mentioned in some Russian mathematical manuscripts (such as, for instance, the extraction of roots). Bobynin (1889) claimed that in the Russian mathematical literature it would be hard to find another work of the same historical significance as the *Arithmetic* by Magnitskii. At the same time, he also raised the question of the originality of the book, since Magnitskii himself defined the book as a compilation based upon several Western sources. In the same vein, A. Vucinich (1963) argued that the *Arithmetic* was not a summary of the mathematical knowledge that existed in Russia but rather an encyclopaedia of various relevant items mostly translated from Western sources; still it was not completely unoriginal, and its author showed much “ingenuity in the organization of material, explanatory notes, and selection of examples” (p. 54).

The question of originality of Magnitskii’s book remains one of the most frequently discussed by later authors. For example, Ivasheva (2011) mentions that while Magnitskii borrowed much of contents and terminology from the mathematical manuscripts that circulated in Russia prior to the early 18<sup>th</sup> century, he paid a great deal of attention to general discussions about mathematics in which arithmetic was described as a “honest art, envy-free, readily grasped by all, wholly useful” (p. 39). In turn, Mishchenko (2004) mentions that recent researchers still have no general opinion concerning the sources that Magnitskii used as the basis of his *Arithmetic*. The latter author refers to the analysis of Yushkevich (1968) who believed that Magnitskii used manuscript and printed materials of earlier times, which he carefully selected and substantially modified to compose an original work, taking into account the knowledge and demands of the prospective Russian readers.

In order to provide more insights into the essence of the debates about the didactical value of Magnitskii’s work, we briefly summarize a discussion between D. Galanin (1857-1929) (1914) and V. Bobynin (1889) regarding the introduction of addition of

integer numbers in the *Arithmetic* as compared with the same topic in the *Arithmetica oft reken-konst: En een kort onderricht van't italiaens boeckhoudē* published in Amsterdam in Dutch by Jacob Van Der Schuere (Schuere, 1643); the latter textbook shared a number of striking similarities with Magnitskii's textbook, briefly discussed in our publication (Freiman and Volkov 2012). While Bobynin called these similarities “borrowing” (‘zaimstvovanie’), Galanin referred to them as “inspection/getting familiar with” (‘oznakomlenie’), that is, he suggested that Magnitskii knew the textbook of Schuere but introduced the elements of its contents differently, in pursuing his own didactical goals, which brought originality to his work. Schuere's and Magnitskii's introductions of addition are shown in Figure 1:

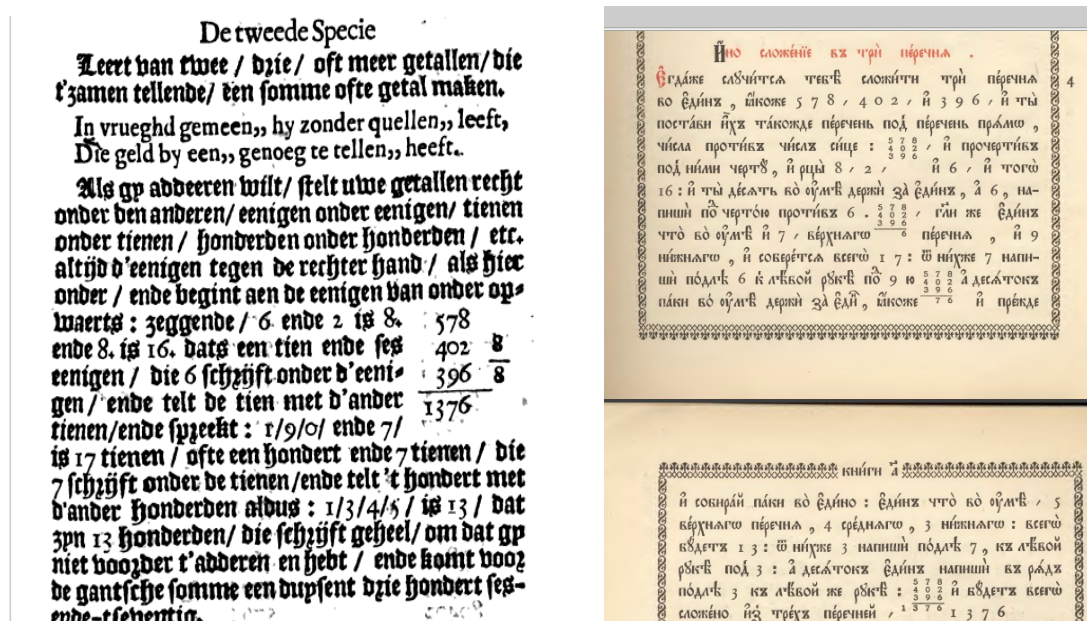

Figure 1: Explanations of addition in Schuere (left) and Magnitskii (right).

In his textbook, after mentioning that two, three or more numbers taken together produce a sum, Schuere provides an example of adding 578, 402, and 396 by placing them one under another, aligning the numbers by the position of units and separating them from the sum with a horizontal line. The same example (using the same numbers) can be found in Magnitskii's book, yet explanations of each step are much more detailed. Moreover, before giving this example, Magnitskii introduces another, simpler one, with only two numbers to be added (532 + 46) which he uses to introduce the steps needed to perform addition. This example is missing in Schuere's book. Magnitskii completes his explanation of the procedure with yet two more examples placed under the sub-title “Common rule” (missing in Schuere), and also extends the introductory part of the section, very short in Schuere, beyond the definition of what addition is (“collection or combination of several numbers”) by providing a table of basic facts about numbers: in each pair of columns, we see numbers 1-9 on the left, other numbers, from 1 to 10 shown in the middle part can be added to them, and the results are shown on the right side, e.g., “7 + 6 = 13”; see Figure 2:



Figure 2: Magnitskii's 'innovations' – addition table (left) and common rule (right).

In both textbooks of Schuere and Magnitskii, the explanation of addition is followed by several examples that look like exercises or “drills” for the learners. There is an obvious similarity between the two sets of drills:

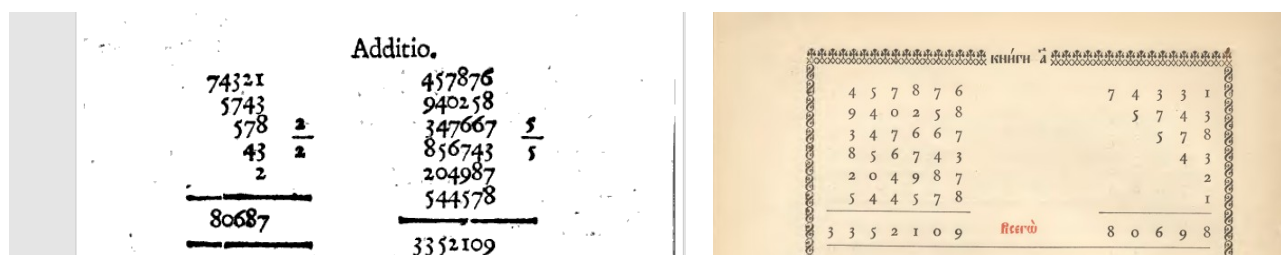

Figure 3: Exercises from Schuere (left) and Magnitskii (right).

The comparison of the contents of the two books made Bobynin claim that Magnitskii simply translated Schuere's book, while for Galanin, Magnitskii work was a way of enriching sources known to him with original didactical ideas that we still need to grasp. The size limits of this paper does not allow us to provide a deeper analysis of the examples; meanwhile, it is important to stress that Magnitskii's book contains more examples than that of Schuere, and they are of different kind. It is also interesting that both authors introduced in their texts several word problems that prompted application of addition, yet, according to Galanin, problems in Magnitskii's textbook are simpler than those in Schuere's book. Curiously enough, when Bobynin sees a larger number of examples and more detailed explanations, he considers them Magnitskii's didactical weakness, while Galanin in similar cases emphasizes originality and usefulness of this method for the learner.

## CONCLUSIONS: SETTING UP A RESEARCH AGENDA

Magnitskii's arithmetical manual was often mentioned in works on the history of mathematics in Russia; however, no special attention, with very few exceptions, was paid to its analysis in didactical perspective. Meanwhile, the work in this direction cannot be accomplished without a detailed exploration of the didactical tradition in Russian mathematics that existed prior to the publication of Magnitskii's manual; moreover, the circumstances of mathematical training obtained by Magnitskii, while being crucial for the present study, remain unknown. However, even the cursory study briefly reported in the present paper strongly suggests that the modifications of



mathematical methods and concepts most likely borrowed by Magnitskii from a number of Western textbooks of the 17<sup>th</sup> century resulted from the latter's attempts to make those methods and concepts fit into the didactical framework of the early 18<sup>th</sup> century Russia.

## References

- Bellyustin, V. K. (Беллюстин, В. К.) (1909). *Как постепенно дошли люди до настоящей арифметики* [How did people gradually reached the true arithmetic, in Russian]. Moscow: Men'shov Publishing Company (Типография К. Л. Меньшова).
- Vobynin, V. V. (Бобынин, В. В.) (1889). Очерки истории развития физико-математических знаний в России, 'Арифметика' Магницкого (часть 2). [Outlines of the history of development of physical and mathematical knowledge in Russia. The Arithmetic of Magnitskii (part 2), in Russian], *Физико-математические науки в их настоящем и прошедшем*, 8, 28-47.
- Fan, L., Wong, N.-Y., Cai, J., & Li, S. (Eds.). (2004). *How Chinese learn mathematics: Perspectives from insiders*. Singapore: World Scientific.
- Freiman, V., & Volkov, A. (2012). *Common fractions in L.F. Magnitskii's Arithmetic (1703): Interplay of tradition and didactical innovation*. Paper presented at the 12<sup>th</sup> International Congress on Mathematics Education, Seoul, South Korea.
- Galanin, D. D. (Галанин, Д. Д.) (1914). *Леонтий Филиппович Магницкий и его Арифметика. Выпуски 2 и 3* [Leontii Filippovich Magnitskii and his Arithmetic. Parts 2 and 3; in Russian]. Москва: Типография Сомовой.
- Ivashova, O. (2011). The history and the present state of elementary mathematical education in Russia. In A. Karp & B. R. Vogeli (Eds.), *Russian mathematics education: programs and practices* (pp. 37-80). Singapore: World Scientific.
- Karp, A., & Vogeli, B. R. (Eds.). (2010). *Russian mathematics education: History and world significance*. Singapore: World Scientific.
- Karp, A., & Vogeli, B. R. (Eds.). (2011). *Russian mathematics education: Programs and practices*. Singapore: World Scientific.
- Leung, F. K. S. (2001). In search of an East Asian identity in mathematics education. *Educational Studies in Mathematics*, 47(1), 35-51.
- Ma, L. (1999). *Knowing and teaching elementary mathematics: Teachers' understanding of fundamental mathematics in China and the United States*. Mahwah, NJ: Lawrence Erlbaum Associates.
- Magnistkii, L. (Магницкий, Л.) (1703). *Арифметика, сиречь наука числительная, с разных диалектов на словенский язык переведеная, и во едино собрана, и на две книги разделена* [Arithmetic, or learning of numbering, translated into Slavic language from different dialects, assembled and divided into two books]. Moscow.
- Mishchenko, A. S. (2004). *The first printed mathematics book in Russia*. Presentation at the 10<sup>th</sup> International Congress on Mathematics Education, Copenhagen, Denmark.

- Polanyi, M. (1958). *Personal knowledge: Towards a post-critical philosophy*. Chicago, IL: University of Chicago Press.
- Okenfuss, M. J. (1995). *The rise and fall of Latin humanism in early-modern Russia: Pagan authors, Ukrainians, and the resiliency of Muscovy*. Leiden: Brill.
- Schuere, J. van der (1643). *Arithmetica oft reken-konst: En een kort onderricht van't italiaens boeckhoudē*. Amsterdam.
- Spagnolo, F., & Di Paola, B. (Eds.). (2010). *European and Chinese cognitive styles and their impact on teaching mathematics: Studies in computational intelligence* (Vol. 277). Berlin: Springer.
- Vucinich, A. (1963). *Science in Russian culture: A history to 1860*. Stanford, CA: Stanford University Press.
- Xie X., & Carspecken, P. F. (2008). *Philosophy, learning, and the mathematics curriculum: Dialectical materialism and pragmatism related to Chinese and U.S. mathematics curriculums*. Rotterdam and Taipei: Sense Publishers.
- Yushkevich, A. P. (Юшкевич, А. П.) (1968). *История математики в России до 1917 года* [History of mathematics in Russia prior to 1917, in Russian]. Москва: Наука.

# BLACK AND WHITE MARBLES – OLDER PRIMARY STUDENTS' INTUITIVE CONCEPTIONS AND APPROACHES CONCERNING RATIOS

Torsten Fritzlar<sup>1</sup>, Roland Rink<sup>2</sup>

<sup>1</sup>University of Halle-Wittenberg, <sup>2</sup>Humboldt-University of Berlin

*We encounter ratios on a daily basis. They also play an important role as a basic construct of thinking in many areas of school mathematics. For example, a fraction can be interpreted as the ratio of a part to the respective whole. Many children appear to have difficulties with fractions and although the concept of ratios is crucial for this subject area, there has been hardly any scientific research on how the understanding of ratios is developed. In this article, we will highlight, using the “marbles problems”, how children between 3rd and 6th grade handle ratios.*

## INTRODUCTION

In our everyday lives, we come across ratios in various situations. We find them in proportions, game and election results, probabilities, physical quantities such as velocity or density, mixing instructions in recipes, and in scales, to name just a few examples. In some of these cases, the information is expressed using fractions as special ratios; however, ratios are much more multifaceted. Fractions always show parts in relation to the respective whole (**part-whole ratio – PW**), while ratios also indicate the relationship between the parts of a whole (**part-part ratio – PP**), e.g. in game results or mixing proportions. A third way of interpreting the concept of ratio can be seen in the example of velocity, where quantities of different types are put into relation to each other. In the event of such **rate problems (RP)**, new quantities are often formed through reification, which can then be used as new objects of thinking. Furthermore, ratios can be used as *concrete ratios* to characterise a concrete situation or a certain object. According to Führer (1999), this is a formative description method (“*gestaltliches Beschreibungsmittel*”). Also, they can be applied as equivalent ratios in an *abstract* way. In colloquial (German) language use, the term “ratio” is used even more extensively. Führer (2004, p. 46) explains that the German word for “ratio” (“*Verhältnis*”) is used very often, when at least two objects are related to each other in any way (“*[v]on einem Verhältnis spricht man oft schon, wenn mindestens zwei Objekte nur irgendwie in Beziehung gesetzt werden*”). For further details and the basic mathematical principles refer to Rink (2013).

It quickly becomes clear that PW ratios (fractions, percentages, probabilities etc.) and PP ratios (scales, similarities, intercept theorem etc.) play an extremely important role in school mathematics; however, in Germany this topic is not covered explicitly until 7<sup>th</sup> grade. Rate problems (RP), on the other hand, are only scarcely discussed beyond theoretical contexts in mathematics lessons.

Particularly in Anglophone countries, extensive research has already been done on the abilities in handling ratios (e.g. Hart, 1980; Karplus et al., 1983). However, the participating children were always at least 12 years old. With reference to Piaget (Piaget & Inhelder, 1973), it has been widely assumed that younger students are not able to handle ratios successfully. Some studies (e.g. Streefland, 1984) – though lacking a theoretical differentiation of the concept of ratio and respective variations of test items – and first studies conducted by the second author (Rink, 2013), however, show that primary school children absolutely have the potential to handle ratios successfully. Even if multiplicative thinking is considered to be the probably most important requirement for dealing with ratios successfully (Rink, 2013), children are actually able to discuss ratios on a qualitative level before being taught multiplication in school (Adhami, 2004; Streefland, 1984).

The importance of ratios in our everyday lives and in school mathematics on the one hand, and the apparently related high cognitive requirements on the other hand, seem to call for further systematic research on this matter.

## **RESEARCH QUESTIONS AND USED METHODS**

The following pilot study shows only examples of the capabilities of older primary school children<sup>1</sup> in handling ratios, however studying a bigger group including pupils from four grades. The subjects of the study were primary students from 3<sup>rd</sup> to 6<sup>th</sup> grade. We were interested in their “natural” way of handling certain ratio problems before corresponding algorithms and concepts are systematically taught in school. The youngest participants of the study were pupils who had just started 3<sup>rd</sup> grade, which makes sense, because at this age children have a solid understanding of multiplication. This is considered to be crucial in the successful handling of ratios and, in Germany, is first taught in 2<sup>nd</sup> grade. Furthermore, this composition of participants gave us a chance to also look into possible effects of the systematic introduction of fractions in 5<sup>th</sup> grade. In doing so, our aim was not only to gather quantitative information of resolution rates, but also to particularly investigate the pupils’ methods in a qualitative manner.

Regarding the high importance of the ratio types PW and PP in school mathematics, we decided to make them the main focus of this pilot study. Further, these ratio types allow for context-free problem situations, thus reducing the influence of previous experience and (mis-)conceptions from non-mathematical areas. In contrast, most previous studies on the subject of handling ratios placed the problems in various contexts. On the one hand, this ensured that the participants understood that they had to work with ratios, but, on the other hand, the results varied greatly and were barely comparable (e.g. Hart, 1980; Noelting, 1980; Streefland, 1984; Rink, 2013). Also, these studies usually did not take possible changes over several education levels into account.

Another aim of our research was to understand the pupils’ ideas of the concept of “ratio” on a linguistic level as well as possible relations to their abilities of handling the

---

<sup>1</sup> In the state of Berlin, primary school comprises grades 1 to 6.

respective problems. We are not aware of any previous studies on this subject, neither in Germany nor internationally.

The study was mainly carried out in Berlin primary schools during the first few weeks of the school year. In order to ensure as much heterogeneity within the group of participants as possible, eleven schools from different urban school catchment areas with and without mixed-level learning groups were involved. All 231 participating schoolchildren were asked to do the following exercise in writing:

In a box, there are 10 marbles –  
black and white ones.  
Take a look at the image.

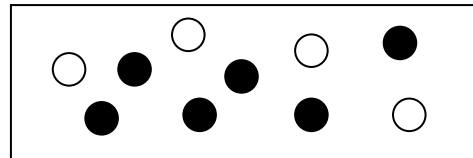

1. How many white marbles would you have to remove from these 10 marbles, to leave half as many white as there are black marbles? Explain your solution.
2. How many black marbles would you have to add to these 10 marbles, so that three quarters of all marbles are black? Explain your solution.
3. What is the ratio between the white and the black marbles? Explain your solution.

Figure 1: Marbles problem

The first problem covers PP ratios, which play an important role in everyday life. Since “half as many” is a rather simple ratio and, moreover, the reference quantity is known, the question concerning the number of white marbles should be relatively easy to answer for many children. It is interesting to observe how, going from there, the pupils manage the transition to the second question, which is a PW problem. Not only does the ratio “three quarters” make it more challenging, but it is especially more difficult because the reference quantity is unknown. While the first two problems work without the term *ratio*, the third question requires the pupils to explain their intuitive understanding of the concept. This only happens in the last problem in order to keep the influence of possibly induced ideas, associations or affects on the first two problems to a minimum.

The data collection was carried out by student teachers, who were introduced in the study beforehand to guarantee a widely consistent organisational framework. Afterwards, the data was analysed in tandem by the two authors of this study. In order to conduct qualitative analyses of approaches, we developed descriptive categories based on the collected data (bottom-up), which also refer to elements of the theoretical analysis (top-down) of the ratio concept (cf. section 1).

## RESULTS

The table below shows the resolution rates for the first two marble problems. These results confirm, on the one hand, our a priori estimation of the level of difficulty, which is also supported by the fact that only three of 231 participating pupils were able to

handle the second problem successfully without having answered the first question correctly.

grade	number of pupils	resolution rate of problem 1	resolution rate of problem 2
3	61	70.5%	19.7%
4	57	82.5%	14.0%
5	45	66.7%	15.6%
6	68	80.9%	23.5%
<b>total</b>	<b>231</b>	<b>75.8%</b>	<b>18.6%<sup>2</sup></b>

Table 1: Resolution rates of problems 1 and 2

Even if this does not constitute an actual longitudinal study, the only slightly changing resolution rates and missing tendencies across the education levels suggest, on the other hand, that without systematic teaching of the ratio concept in mathematics lessons, there is no major capabilities increase in this field.

### Problem solving and explaining approaches for the second marbles problem

Table 1 shows clearly that only a small part of the 3<sup>rd</sup>- to 6<sup>th</sup>-grade students participating in the study were able to solve the second marbles problem successfully. Additionally, only 68% of these children wrote an explanation for their answers. However, the results still show a broad spectrum of correct or improvable problem solving and explaining approaches, as presented below. On the one hand, this shows the existing capabilities and potentials of the group of participating schoolchildren and, on the other hand, it offers indications for the didactic organisation of teaching the ratio concept in mathematics lessons.

Anne (9 years old, 4 <sup>th</sup> grade) solves the problem in the following way:	
	Description: <b>Three times as many are black.</b> Even if the problem text description suggests a PW ratio, this pupil handles the exercise with a PP approach and triples the number of white marbles in order to determine the number of black marbles. Fractions or ratios, however, are not expressed.
Translation: <i>You would have to add six black marbles, because <math>4 \cdot 3 = 12</math>. Because if you multiply the white ones by 3, it's 12 and <math>6 + 6</math> (<math>\rightarrow</math>black) = 12</i>	

<sup>2</sup> Some pupils suggested the solution “three black marbles”. This would be correct, if one were to take the result of problem 1 as a starting point. Under consideration of these suggestions, the resolution rate would be 24.2%.

Bea (11 years old, 6 <sup>th</sup> grade) solves the problem in the following way:	
<p><i>- 6 hinzufügen. - habe die weißen u. die schwarzen gezählt</i></p> <p><math>4 = \frac{1}{4} \cdot 3 = 12 = \frac{3}{4}</math></p>	<p>Description: <math>\frac{1}{4}</math> is 4, <math>\frac{3}{4}</math> is 12. From the quarter of a whole three quarters are calculated – similar to Anne’s multiplication approach. The girl does not name the whole, which is why the approach can be interpreted as PP approach.</p>
<p>Translation:</p> <p>- add 6</p> <p>- I counted the white and the black ones</p> <p><math>4 = \frac{1}{4} \cdot 3 = 12 = \frac{3}{4}</math></p>	

Charles (9 years old, 3 <sup>rd</sup> grade) uses a sketch.	
	<p>Description: <b>PP approach with a sketch.</b> This boy draws 3 black marbles for each white marble. Because Charles forgets one marble, he receives an incorrect result.</p>

Danny (11 years old, 6 <sup>th</sup> grade) solves the problem in the following way:	
<p><i>Man müsste sechs schwarze Kugeln dazufügen damit man ein Verhältnis <math>4:12</math> hat und <math>16:4 = 4</math> und <math>12:4 = 3</math>.</i></p>	<p>Description: <b>3:4 → 4:12.</b> This pupil develops a PP ratio that goes with the PW ratio provided in the problem text description. Danny’s exact approach cannot be reproduced.</p>
<p>Translation:</p> <p>You would have to add six black marbles to get the ratio 4:12 (w.:b.) and <math>16:4 = 4</math> and <math>12:4 = 3</math>.</p>	

Ethan (10 years old, 5 <sup>th</sup> grade) solves the problem in the following way:	
<p><i>Man muss 6 schwarze Kugeln hinzufügen den 4 Kugeln sind ein Viertel weil es 4 weiße Kugeln gibt und <math>4 \cdot 4 = 16</math> das plus 6.</i></p>	<p>Description: <math>\frac{1}{4}</math> of all marbles is white. In this PW approach, the pupil uses the number of white marbles to determine the total number and, going from there, calculates the number of black marbles that need to be added.</p>
<p>Translation:</p> <p>You have to add 6 black marbles, because 4 marbles are a quarter, because there are 4 white marbles and <math>4 \cdot 4 = 16</math>, so that’s why it has to be plus 6.</p>	

Frieda (8 years old, 4 <sup>th</sup> grade) “tries” to reach a solution.	
	<p>Description: <b>Trying (PW).</b> Frieda attempts to reach the required, modified PW ratio by trying different options.</p>
<p>Translation:</p> <p><math>10:4 =</math> doesn’t work</p> <p><math>11:4 =</math> doesn’t work</p> <p><math>12:4 = 3</math> in each quarter</p>	

Figure 2: Problem solving and explaining approaches

We were able to identify the first approach in a particularly large part of problem solutions collected from the participating pupils. It seems remarkable that about three quarter of the exactly reconstructable approaches can be interpreted as PP approaches, even if the second marbles problem is actually a PW problem.

### Pupils' conceptions on ratio

The participating schoolchildren's solutions for the third problem showed a very broad spectrum of understanding the term "ratio". We are seeking to illustrate this in a first approach by using the following answer categories, which have been developed based on the collected data:

- **ratio**: Answers of this category specify the ratio between the numbers of white and black marbles, e.g. in the forms "4:6" or "4 to 6", sometimes even naming the term "ratio". Pupils of higher education levels also used percentages, as in "40% to 60%", or "cancelled" ratios, such as "1:1.5" or "1:1½". None of the participants, however, used the basic ratio 2:3. All answers in which pupils specified a ratio were correct.
- **comparison**: A big part of the children compared the numbers of marbles according to their respective cardinality and said that there are "more black than white" marbles. Sometimes they commented on how many white marbles would have to be added in order to leave the same number of black and white marbles.
- **geometric**: Some of the children described the position or formation of the marbles, e.g. "There are two rows of marbles" or "The marbles are facing each other".
- **no answer**: A major part of the participating pupils did not write an answer.
- **others**

Table 2 illustrates that children of higher education levels showed, as expected, increasing capabilities in expressing scientifically correct ideas of the term "ratio". However, even among 6<sup>th</sup>-grade pupils, still less than half of the participants succeeded in putting an appropriate answer into writing. It was also rather surprising that answers of the category *geometric* were given more often by older pupils than younger ones.

	3rd grade	4th grade	5th grade	6th grade
<b>ratio</b>	23%	19%	37%	44%
<b>comparison</b>	9%	33%	19%	6%
<b>geometric</b>	0%	1%	8%	11%
<b>others</b>	23%	17%	13%	11%
<b>no answer</b>	45%	29%	22%	20%

Table 2: Pupils' answers to the third marbles problem



We did not detect any statistically significant links between the types of pupils' answers to the third marbles problem and the successful solving of the first two problems. This outcome matches the results of other studies which showed that children have the ability to work with ratios on a *qualitative* level at a very young age already, without needing any rather formal aspects (Adhami, 2004; Lorenz, 2011).

## DISCUSSION

The pilot study presented in this article shows that most of the 231 participating 3<sup>rd</sup>- to 6<sup>th</sup>-grade pupils were able to solve an easy ratio problem successfully. However, the results of the second marbles problem also indicates that the required capabilities among the studied age group do not develop by themselves, but rather require systematic teaching in mathematics lessons. Furthermore, the problem solving and explaining strategies applied for the second problem suggest a certain flexibility and confidence of the pupils in working on PP problems. Therefore, PP problems and their respective solving approaches might possibly be used as starting points for suitable learning trajectories.

In an already planned follow-up study, the number of participating schools and thus the heterogeneity within the group of participants will be increased. This study will not only include systematically varying PP and PW problems, but also rate problems that are phrased with little context, e.g. using exchange situations.

## References

- Adhami, M. (2004). Ratio for all! *Equals Online: Mathematics and Special Educational Needs*, 10(3), 5-7.
- Führer, L. (1999). *Logos und Proportion – Gestaltliche Aspekte von Bruchzahlbegriff und Bruchrechnung*. Frankfurt am Main: Universität Frankfurt.
- Führer, L. (2004). Verhältnisse: Plädoyer für eine renaissance des proportionsdenkens. *Mathematik Lehren*, 123, 46-51.
- Hart, K. M. (1980). *Secondary school-children's understanding of ratio and proportion* (Unpublished doctoral dissertation). London: University of London.
- Karplus, R., Pulos, S., & Stage, E. K. (1983). Proportional reasoning of early adolescents. In R. Lesh & M. Landau (Eds.), *Acquisition of mathematics concepts and processes* (pp. 45-90). Orlando, FL: Academic Press.
- Lorenz, J.-H. (2011). Proportionale Zusammenhänge verstehen lernen. *Grundschule Mathematik*, 29, 14-17.
- Noelting, G. (1980). The development of proportional reasoning and the ratio concept. Part I – Differentiation of stages. *Educational Studies in Mathematics*, 11(2), 217-253.
- Piaget, J., & Inhelder, B. (1973). *Die Entwicklung der elementaren logischen Strukturen* (Vols. 1-2). Düsseldorf: Schwann.

Rink, R. (2013). *Zum Verhältnisbegriff im Mathematikunterricht: Theoretische Grundlegung und Analyse kindlicher Vorgehensweisen im Umgang mit Verhältnissen im vierten Schuljahr*. Hildesheim: Franzbecker.

Streefland, L. (1984). Search for the roots of ratio: Some thoughts on the long term learning process (towards ... a theory). Part I: Reflections on a teaching experiment. *Educational Studies in Mathematics*, 15(4), 327-348.

Strehl, R. (1979). *Grundprobleme des Sachrechnens*. Freiburg: Herder.

# WHY LECTURES IN ADVANCED MATHEMATICS OFTEN FAIL

Tim Fukawa-Connelly<sup>1</sup>, Kristen Lew<sup>2</sup>, Pablo Mejia-Ramos<sup>2</sup>, Keith Weber<sup>2</sup>

<sup>1</sup>Drexel University, <sup>2</sup>Rutgers University

*This case study investigates the effectiveness of a lecture in advanced mathematics. We video recorded a lecture delivered by an experienced professor. Using video recall, we then interviewed the professor to determine the content he intended to convey and we analyzed his lecture to see if and how this content was conveyed. We also interviewed six students to see what they understood from this lecture. The students did not comprehend much of the content that the professor intended to cover in his lecture. We propose three reasons for why students failed to grasp much of the content that the professor intended to convey.*

## INTRODUCTION

This paper investigates the seeming paradox that an excellent mathematics teacher delivering a high-quality lecture may not result in student learning gains. The specific context we study is the proof-based real analysis course. There is a widely held belief amongst mathematics educators that most lectures in advanced mathematics are ineffective for developing students' understanding of mathematics (e.g., Davis & Hersh, 1981; Dreyfus, 1991; Rosenthal, 1995). Perhaps the most common complaint is that the predominance of definitions, theorems, and proofs in lectures leads the lecturer to pay scant attention to other important types of mathematical thinking (e.g., Davis & Hersh, 1981; Dreyfus, 1991). Consequently issues such as informal ways of understanding mathematical concepts (e.g., graphical or diagrammatic interpretations of concepts), why theorems appeared plausible to mathematicians, and how these proofs could have been constructed are (purportedly) largely ignored in advanced mathematics lectures. Yet, extant case studies (e.g., Fukawa-Connelly & Newton, in press; Weber, 2004) show lecturers use informal representations of concepts such as examples and diagrams to help students understand the content. Similarly, the interview data of Yopp (2011) and Weber (2012) found that mathematics professors claimed to focus on things such as providing explanation and illustrating proof methods, rather than a formal proof.

Research has generally not explored how mathematics majors comprehend or gain understanding from the proofs that they read (Mejia-Ramos & Inglis, 2009). This case study examines the presentation of proof in a real analysis lecture and what students might learn from it via the following research questions:

1. What content did the professor intend to convey in his lecture?
2. How was this intended content presented in his lecture (if at all)?
3. What did the students in this class perceive to be the important content in the proof and did it align with the professor's goals?

4. In cases where students' interpretations of the lecture differed from the professor's intent, what factors could explain these discrepancies?

## THEORETICAL PERSPECTIVE

According to de Villiers (1990), mathematicians engage in the activity of proving for five different purposes: (1) to *verify* that a theorem is true and that the conclusion of a theorem being proven is a necessary consequence of the premises of that theorem (although de Villiers emphasized that this was not the primary function of proof); (2) to go beyond verifying that a theorem and *explaining why* it is true (Hanna, 1990, and Hersh, 1993, argued that explanation should be the primary function of proof in the classroom); (3) to *discover* new ideas and methods that will help mathematicians solve problems that they are working on (Mejia-Ramos and Weber, in press, reported that mathematicians claim this is one of the main reasons they read proofs); (4) to *communicate* new mathematical ideas, tools, and proof techniques with other mathematicians; and (5) to *systematize* a body of mathematical knowledge by showing how new definitions or axiom systems can account for results that are known to be true (cf., Weber, 2002). In this report we focus on the second and third purposes: using a proof as an *explanation* for a particular mathematical idea and as a way to *discover* new methods students could use to solve other problems.

We also follow the New Literacy Studies movement (Gee, 1990) and treat the totality of a lecture, including the words spoken by the professor, his chalk inscriptions and kinesthetic movements, as a single coherent piece of text. Our interest is in the meanings that the professor attempted to imbue in the text, the meanings that students constructed from reading this text, and discrepancies that may arise between the two. Our theoretical analysis suggests three reasons that students might fail to understand a proof in lecture: (i) the professor may not believe conceptual explanations and methods are important and not include them; (ii) the professor might fail to encode the content into the text, (iii) the students might lack the tools to interpret the text.

## METHODS

### The lecture

This research took place at a large American state university, in a real analysis course, which is, as is typical for the U.S., a junior-level course required for mathematics majors. We studied a section of the course taught by Dr. A (a pseudonym), a highly-experienced and well-respected instructor, videotaping one of his lectures. This study focuses on the proof from that lecture that we felt was the most conceptually interesting. To avoid ambiguity, we refer to the *blackboard proof* as the text that Dr. A inscribed on the blackboard and the *lecture proof* as the totality of the 10-minute segment. Our analysis of the *lecture proof* suggested that there is substantial content that can be learned from it. That content could focus on explanation, methods (i.e., discovering how to find new theorem), or conviction/validity. For the sake of brevity,

we focus on the use of Cauchy sequences (methods) and that Cauchy sequences are those that bunch up (explanation).

After the initial analysis of the text, the 2<sup>nd</sup> author met with Dr. A for an audio-recorded interview. The interview focused on the main ideas he wished to convey via the proof presentation and used video recall to prompt him to reflect on how he attempted to convey those ideas. When we analyzed Dr. A's comments, if they were consistent with what we observed, we would fold them into the categories that we formed in our analysis of the lecture. If he introduced new ideas or described the content that we observed in a different way, we would form a new category.

### **Student data**

We collected notes and interviewed six students. The interviews were with pairs of students and video recorded. Pair 1 consists of S(tudent)1 and S2, Pair 2 is S3 and S4, Pair 3 is S5 and S6. From Dr. A's perspective, these students displayed a wide range of performance, but were collectively above average in their class. We asked the students to consider the lecture proof in three passes. First, we asked them to describe what they learned from the lecture based upon their notes to see what they could reconstruct. Second, we showed them the entire proof on video in order to explore their interpretations of what Dr. A considered the main ideas of the proof. In the third pass, we showed the students short clips of the lecture and after each clip, asked what they understood to measure whether the participants had the means to interpret what Dr. A considered to be the main content of the proof. In each pass, we compared their claims to the conceptual meaning that Dr. A ascribed to the proof presentation.

### **THE LECTURE**

First, we note that Dr. A's lecture proof was more detailed than his blackboard proof. The latter was a polished proof that might appear in a textbook. However, in the lecture proof, he supplemented the blackboard proof with many oral comments about the proof writing process and his thinking about concepts. That is, all statements about the methods and content he intended to convey were stated orally, not written on the blackboard.

In the theorem about sequences that Dr. A proved in class, a specific sequence is not given. Rather, the theorem states that the sequence has the property that the distance between any two consecutive elements  $x_n$  and  $x_{n-1}$  is less than  $r^n$ , where  $r$  is a constant with  $0 < r < 1$ . One cannot prove that such a sequence converges simply by applying the definition of convergence (given that we cannot know what the limit will be), so another approach is needed. In the proof presented by Dr. A, the sequence is shown to be convergent by demonstrating that it is a special type of sequence called a Cauchy sequence (in a previous class, students had seen a proof that all Cauchy sequences are convergent sequences). A key point stressed at several points in Dr. A's lecture proof is that this theorem was useful to apply when one wanted to prove a sequence was convergent, but could not determine what the limit of the sequence was.

## **ANALYZING THE TEXT VIA THE PERSPECTIVE OF ITS AUTHOR**

When asked why he chose to present this proof, Dr. A gave an 11 minute response, situating Cauchy sequences along students' mathematical progression starting with calculus and concluding with the study of measurable functions in graduate school. He tied this to the importance of repetition of ideas, suggesting that students do not gain intuition and understanding the first time they view a proof. Rather, he believed students came to grasp ideas through repeated exposure. Describing the main things he intended to convey to students with this proof, Dr. A emphasized thinking of Cauchy sequences in terms of pictures, using the word "picture" 32 times. He began:

What has to be emphasized over and over again is that these definitions, which you might write down in symbols, are not going to make sense to you unless you have a picture associated with it.

However, when viewing the proof, Dr. A was surprised that he actually did not include any pictures, saying "this is a poor example. There are no pictures here!" When asked what content he was trying to convey while presenting this proof, he cited that he wanted students to view these sequences as "bunching up," which from our perspective implied that the terms of the tail of the sequence would become arbitrarily close together and "bunch up" around a particular point. Dr. A explained:

If you go far enough out in the sequence, the difference between any two terms whose index, the  $m$ , the  $n$ , are large enough. Will always be less than epsilon. What that says is that they bunch up [Dr. A places hands vertically and parallel to one another and slowly moves his two hands towards each other]. So the Cauchy property for a sequence is, the property says they bunch up [Dr. A repeats the gesture described above] in some place.

## **STUDENTS' PERCEPTIONS OF THE LECTURE**

### **Pass 1: Students' recall of the content of the lecture from their notes**

First, we note that five of the students recoded only what was written on the board in their notes. The sixth student (S1) was an exception: she recorded nearly everything Dr. A said aloud, as well as what he wrote. The students did not mention the content that Dr. A aimed to convey in this proof, although their summaries did, generally, have mathematical value. No student mentioned the critical point, emphasized thrice in the Dr. A's presentation, that using Cauchy sequences to establish convergence was specifically useful if one did not know what value to which the sequence converged. Perhaps they did not recall this content from their notes because it was part of Dr. A's oral but not written presentation and they only recorded the written proof.

### **Pass 2: Students' perceptions of the content after viewing the proof**

Students' comments in this pass through the data (i.e. after showing them a video-recording of Dr. A's presentation of the proof) were more detailed than in the first pass. Although all pairs of students highlighted important content in the proof, none of the students mentioned that showing a sequence is Cauchy is an important method for proving the sequence is convergent *particularly* when one does not know

what the limit of the sequence is. Two pairs of students mentioned that showing the sequence was Cauchy was a way of establishing convergence and S4 observed the repetition of this proof structure:

Other than showing that a contractive sequence is a Cauchy sequence, I think it's more. He's showing more of the structure of the proof [...] A lot of the proofs that we did over the last nine or so weeks basically have the same structure [...]

But no student mentioned the conditions under which this was likely to be useful even though Dr. A emphasized these conditions at three separate points in his lecture.

### **Pass 3: Students' interpretations of specific video clips**

In Clip 1, Dr. A claimed to be trying to give students some geometric intuition for what was being asserted in the theorem and why the theorem was true (the sequence, like Cauchy sequences, bunches up), our analysis of his presentation suggested that such content was available from his lecture proof, but not from the blackboard proof. By this pass, S2, S5 and S6 indeed believed this clip was trying to establish geometric intuition for why the sequence converged, that is, that the sequence was 'bunching up'. S2 said, "I mean, this is fairly intuitive. You look at it and the  $r$  to the  $n$ 's are going to keep going up and so this interval is going to keep shrinking, so of course it would be natural to suggest Cauchy sequence." The idea of the interval shrinking is what Dr. A meant by 'bunching.' Both S3 and S4 said that Dr. A was trying to convey that one can show a sequence is Cauchy without knowing its limit, but only describe Cauchy sequences as 'bunching up' after the interviewer directly asked them if the clip suggested that.

In Clip 2, Dr. A introduced the idea of Cauchy sequences as a way to show that a sequence is convergent. Dr. A asks the students what types of sequences converge even if the limit cannot be determined, saying:

There's no mention of what the definition is of the sequence, so there's no way we're going to be able to verify the definition limit of a convergent sequence, where we have to produce the limit. So what do we do? [...] What kind of sequences do we know converge even if we don't know what their limits are? It begins with a 'c'.

Both Pair 1 and Pair 2 believed Dr. A was trying to convey that one can show a sequence is convergent by showing it is Cauchy, which is useful if you do not know the limit of the sequence. For instance, S1 said, "we should recognize it, like to figure out it's a Cauchy, we should know that it's converging, but its limit is not necessarily given." However, Pair 3 did not mention this.

In Clip 3, Dr. A explicitly highlights that one can show a sequence is Cauchy without knowing what the limit is:

We will show that this sequence converges by showing that it is a Cauchy sequence [writes this sentence on the board as he says it aloud, then turns around to face class]. A Cauchy sequence is defined without any mention of limit.

Pair 1 and Pair 2 repeated that the intent here was to remind students that one can show a sequence was Cauchy without knowing its limit. Pair 3 again made no comment of this type.

In Clip 4, Dr. A again reiterates that one cannot find a limit for the sequence in the theorem and showing the sequence is convergent involves showing that it is Cauchy.

And now we'll state what it is we have to show. ... See there is no mention of how the terms of the sequence are defined. There is no way in which we would be able to propose a limit  $L$ . So we have no way of proceeding except for showing that it is a Cauchy sequence or a contractive sequence. So let's look and see how we proceed.

Only Pair 2 remarked that Dr. A was trying to convey that one needed to use Cauchy sequences to establish convergence because one could not propose a limit of the given sequence. Both students in Pair 1 were unsure of the intention of the clip.

For Pair 3, S6 mentioned that the limit of the sequence could not be determined. He said, "he wanted to emphasize that there is no mention of limit whatsoever, so we won't like confuse it with the concept of limit". Our interpretation of this excerpt is that they perceived Dr. A as noting that their previous approaches to showing convergence, which relied on knowing the limit of the convergent sequence, would be inadequate for this problem. Pair 3 did not, however, mention that showing a sequence was Cauchy would be useful since the definition of Cauchy sequences did not involve the definition of limit even when specifically asked whether the clip suggested that showing the sequence was Cauchy would be useful.

### **Summary of students' perceptions of the lecture**

When shown specific clips that Dr. A highlighted, the students were collectively much better at identifying what Dr. A aimed to convey, than when recalling the content of the lecture just from their notes (Pass 1) or after showing them a video-recording of Dr. A's presentation (Pass 2). As this content concerned conceptual explanation and method, the findings above indicate that these students could decode some of this content that Dr. A expressed orally, if asked to do so immediately after viewing his comments regarding that specific content.

First, all three pairs of students observed that the proof illustrated a new way to show a sequence was convergent—namely by showing that it was Cauchy—and Pair 1 and Pair 2 remarked on this in the first pass through the proof. However, the conditions under which this was useful, when a limit for the sequence could not be proposed, were less prevalent in students' responses. Pair 1 and Pair 2 did not mention this until the third pass through the data and Pair 3 did not discuss this content in any pass through the data. Similarly, Pair 1 and Pair 3 that Cauchy sequences 'bunch up' but only when shown the specific short clips in which this was mentioned while Pair 2 only stated this as true when the interviewer specifically asked them if it would be seen in the data. Finally, there were two instances where students described content but at a more shallow level than Dr. A intended.



## DISCUSSION

Consistent with claims from the literature (Yopp, 2011; Weber, 2012), Dr. A emphasized conceptual explanations and method content when discussing this proof. Dr. A valued conceptual explanatory content in the form of pictures, but did not include any in his proof which aligns with findings suggesting that while mathematicians value such informal ways of thinking, their actual decisions about teaching might de-emphasize them (Alcock, 2010; Lai & Weber, 2013). Also, Dr. A would state his method content orally, but not include it in his blackboard proof, which is consistent with other findings from the literature (Fukawa-Connelly, 2013; Weber, 2004). Further investigation is necessary to see how common this practice is.

Students were able to say more about some of the content of the proof when presented with a short clip in which Dr. A encoded this content than in the first two passes. Thus, we claim students possessed the means to interpret the lecture proof, but did not use them when watching the lecture proof in its entirety. There are several possible reasons why this may have occurred, ranging from students essentially ignoring this content, not having time or cognitive resources to attend to it, or, simply not prioritizing it in their discussions of the proof. Five of the students only transcribed written content into their notes. Combined with the fact that most of Dr. A's conceptual explanations were stated orally but not written, this suggests a reason for why comprehension was not occurring; students did not see this content as valuable to attend to. Finally, there was some content that both the research team and Dr. A felt was important that students seemed to lack the means to interpret.

There are two significant limitations of this study. The first is that this was a case study studying a single lecture proof. More research is needed to determine how common these themes are with other professors or with the presentation of other proofs. Second, identifying why comprehension fails to occur does not necessarily imply how lectures in advanced mathematics can be improved. Although, some of our projects have demonstrated that students have inadequate beliefs and strategies for reading mathematical proofs (e.g., Weber & Mejia-Ramos, in press) and focus on developing interventions that will help students understand proofs better.

## References

- Alcock, L. (2010). Mathematicians' perspectives on the teaching and learning of proof. In F. Hitt, D. Holton, & P. Thompson (Eds.), *Research in collegiate mathematics education VII* (pp. 63-92). Providence, RI: American Mathematical Society.
- Davis, P. J., & Hersh, R. (1981). *The mathematical experience*. New York: Viking Penguin Inc.
- de Villiers, M. D. (1990). The role and function of proof in mathematics. *Pythagoras*, 24, 17-24.
- Dreyfus, T. (1991). Advanced mathematical thinking processes. In D. Tall (Ed.), *Advanced mathematical thinking* (pp. 25-41). Dordrecht, The Netherlands: Kluwer.

- Fukawa-Connelly, T. (2013). Toulmin analysis: A tool for analyzing teaching and predicting student performance in proof-based classes. *International Journal of Mathematical Education in Science and Technology*. doi: 10.1080/0020739X.2013.790509
- Fukawa-Connelly, T., & Newton, C. (in press) Evaluating mathematical quality of instruction in advanced mathematics courses by examining the enacted example space. *Educational Studies in Mathematics*.
- Gee, J. P. (1990). *Social linguistics and literacies: Ideology in discourses*. Critical perspectives on literacy and education. London: Falmer Press.
- Hersh, R. (1993). Proving is convincing and explaining. *Educational Studies in Mathematics*, 24(4), 389-399.
- Lai, Y., & Weber, K. (2013). Factors mathematicians profess to consider when presenting pedagogical proofs. *Educational Studies in Mathematics*, 85, 93-108.
- Mejia-Ramos, J. P., & Inglis, M. (2009). Argumentative and proving activities in mathematics education research. In F.-L. Lin, F.-J. Hsieh, G. Hanna, & M. de Villiers (Eds.), *Proceedings of the ICMI study 19 conference: Proof and proving in mathematics education* (Vol. 2, pp. 88-93). Taipei, Taiwan.
- Mejia-Ramos, J. P., & Weber, K. (in press). How and why mathematicians read proofs: Further evidence from a survey study. *Educational Studies in Mathematics*.
- Rosenthal, J. (1995). Active learning strategies in advanced mathematics classes. *Studies in Higher Education*, 20, 223-228.
- Weber, K. (2002). Beyond proving and explaining: Proofs that justify the use of definitions and axiomatic structures and proofs that illustrate technique. *For the Learning of Mathematics*, 22(3), 14-17.
- Weber, K. (2004). Traditional instruction in advanced mathematics classrooms: A case study of one professor's lectures and proofs in an introductory real analysis course. *Journal of Mathematical Behavior*, 23, 115-133.
- Weber, K. (2012). Mathematicians' perspectives on their pedagogical practice with respect to proof. *International Journal of Mathematics Education in Science and Technology*, 43(4), 463-475.
- Weber, K., & Mejia-Ramos, J. P. (2013). Effective but underused strategies for proof comprehension. In A. Castro & M. Martinez (Eds.), *Proc. 35<sup>th</sup> Conf. of the North American Chapter of the Psychology of Mathematics Education* (pp. 260-267). Chicago, IL: PMENA.
- Yopp, D. (2011). How some research mathematicians and statisticians use proof in undergraduate mathematics. *Journal of Mathematical Behavior*, 30, 115-130.

# CULTURE AND DISADVANTAGE IN LEARNING MATHEMATICS

Peter Gates<sup>1</sup>, Shafia Abdul Rahman<sup>2</sup>

<sup>1</sup>University of Nottingham, <sup>2</sup>Universiti Sains Malaysia

*There is concern internationally that socio-economic class and ethnicity remain the most significant predictors of outcomes in mathematics; performance is often largely dependent on family income and level of parental education. Consequently the influence of pupils' socio-economic backgrounds remains a major challenge to those of us in the field concerned with achieving equitable education. However, the ways in which socio-economic factors play out in different parts of the world subject to different political systems and structures, remains unclear. In this paper we present an analysis of mathematics achievement in Penang to offer a localized perspective on the ways in which socio-economic status and ethnicity affect achievement.*

## INTRODUCTION

Those who fail or struggle to succeed at mathematics do not come from a broad cross section of society; rather they tend to be those pupils from more disadvantaged neighbourhoods (Kitchen, et al., 2007). Gaps in student outcomes, especially those associated with non-academic factors, are always a source of concern for many educators and education systems. Although the stated aim of most education systems is to elevate every citizen to a better life through education, the observable reality is that a child's academic performance is often largely dependent on family income. Differences in students' socio-economic status remain a major challenge to achieving equitable outcomes though achieving equitable outcomes is not always high up on governments' agendas. In Malaysia, socio-economic class remains the largest driver of student academic outcomes and a major challenge to achieving equitable education are the socioeconomic differences among children. Students' educational achievement correlates with disadvantage in terms of how much a child's parents earn and where they go to school (Malaysian Ministry of Education, 2013).

## EDUCATION IN MALAYSIA

Malaysian education system follows a top-down approach in which all directives concerning education – the national curriculum, standardized assessments, textbooks, training and placement of teachers, professional development programmes, placement of students and provision of facilities are decided by the Ministry of Education. There are three main types of primary schools in Malaysia – the national schools using Malay as medium of instruction and national-type (vernacular) schools using Chinese or Tamil as medium of instruction. National schools are government-owned and operated and student population in these schools tends to be more multiracial, while national-type schools are mostly government-aided, though some are government-owned. The student population in these schools tends to be mono-ethnic,

although the national-type Chinese schools tend to attract around 10% of its population from other ethnic groups (Malays and Indians). In government-aided national-type schools, the government is responsible for funding the school operations, teachers' training and salary, and setting the school curriculum, while the school buildings and assets belong to the local ethnic communities, which elect a board of directors for each school to safeguard the school properties.

## THE MATHEMATICS CURRICULUM

The mathematics curriculum has undergone some significant changes (both in content and in teaching approach) since the 1970s – from traditional, absolutist approach to process-oriented modern mathematics to a more holistic, integrated curriculum. The traditional mathematics taught before the 1970s employed a behaviorist approach where drill and practice was emphasized. The focus was on fast and accurate computation. In the late 70s the modern mathematics program was introduced, which employed a process oriented, problem solving approach. The *Integrated Curriculum*, which employed the constructivist teaching approach, was introduced in 1994, with emphasis on problem solving, group work and values. This curriculum was deemed consistent with the national education philosophy and goals of mathematics education both at the primary and secondary level. At the primary level, the emphasis was on the mastery of computation that led to understanding. The mathematics syllabus is arranged according to hierarchies of computing skills (levels) and all students are expected to master a collection of skills at different levels. The content of the primary mathematics curriculum is categorized into four interrelated areas – Numbers, Measurement, Shape and Space and Statistics. The topics are interrelated and integrated within the various mathematics topics and with other subjects, in the context of problem solving, particularly those related to everyday experiences.

Starting from 2011, the primary school curriculum underwent yet another development called the *Standard Curriculum for Primary School*. As the name suggests, pupils' achievements were measured against certain standards that they are able to acquire and do. The standards are divided into two parts: content standard and learning standard, which are delivered in modular forms according to learning areas. The content standards are statements about cognitive (knowledge) and affective (attitude and values) domains that are expected in learning a topic. The learning standards are statements about what a pupil is able to do in terms of concept and skills acquisition and proficiency.

Although having a national curriculum and centralized deployment of educational resources would seem to suggest that all the schools would perform somewhat similarly, the learning experience that a child experiences is characterized by a number of factors including (but not limited to) geographic location, social background factors, school types, ethnicity structures and cultures. Although the three types of school use the same national curriculum and teaching materials (but using translated versions of

the textbooks), teaching and learning is very much shaped by the school culture, which in turn is characterized by ethnicity.

In this paper we report on the early stages of an ongoing project to examine the mechanisms and contributory sources of low mathematics achievement in Malaysia and the UK. This project was initiated on the grounds that there are many commonalities and discords between Malaysia and England from which researchers can learn. Despite adopting the British education system from the colonial era, Malaysian primary schools have become increasingly organised according to the ethnicity of pupils, rather than being based upon geographical location, is more the case in the UK. Whilst this study aims to examine the effects of locality, poverty and ethnicity on mathematics achievement by focusing on two cities – Penang in Malaysia and Nottingham in England, in this paper we focus only on data from Penang.

Government data from Malaysia shows that pupils from certain groups continue to underperform when compared to their peers and in relation to national expectations:

- Locality – children in states with more rural schools;
- Socioeconomic status – pupils from low socioeconomic background;
- Ethnicity – Malays are outperformed by minority Chinese and Indian pupils.

In the UK pupils seen as seriously underperforming in mathematics tend to be those who live in social housing, and Afro-Caribbean pupils, who are regularly outperformed by minority Chinese and Indian pupils (see Gates and Guo, 2013). Naturally, geographical and political systems and therefore the mechanisms of influence will differ between Malaysia and the UK and particularly between Nottingham, a highly deprived urban city in the UK and Penang, an island state in the north of the Malaysian peninsular. In this project, we are investigating effects of locality, poverty and ethnicity on mathematical attainment. The aim is to offer a more localized perspective to try to understand the ways in which socio-economic status effects students' mathematical and how this is influenced by ethnicity.

## **THE CONTEXT OF PENANG**

The island state of Penang is situated in the northern peninsular of Malaysia, consisting of an island (Pulau Pinang) and Seberang Perai (SP) on the mainland. Its population of 1.6 million consists of 42% Chinese, 40% Malays, 10% Indians and 8% non-Malaysians and others. Its population is thus highly diverse in ethnicity, culture, language, and religion. Traditionally, the Chinese, who work mostly in the business industry, are located in the urban parts of the state while the mostly agrarian Malays and estate worker Indians are mostly in the rural parts. The more economically developed part of the state consists of 50% Chinese, 33% Malays and 8% Indians. The less developed part on the mainland consists of 32% Chinese 50% Malays, and 11% Indians. Others make up the rest.

The school system is highly ethnically segregated. There are a total of 259 primary schools and 127 secondary schools in Penang. We were unable to obtain data on one

Malay and one Chinese school, and coded the rest 1-257. 149 of the primary schools are “national schools” (whose pupils are mostly ethnic Malays), 80 are “Chinese national-type schools”, 28 are “Tamil national-type schools”. These three types of schools are generally ethnicity-based, and the teachers tend to be of the same ethnicity (except for language teachers). The national schools consist of 94% local Malays, 3% Indians, 1% Chinese and 2% other races. The Chinese national-type schools consist of 88% Chinese, 9% Malays, 2% Indians and 1% others, while the Tamil national-type schools are 100% Indians. Out of the 271 primary schools, 143 (53%) are urban schools and 128 (47%) are rural schools. In order to simplify language, we hereinafter refer to these school types as Malay, Chinese or Tamil to represent the majority ethnicity in each.

## **METHODOLOGY**

Our aim is to explore the possible existence of any effects of locality, ethnicity and poverty on pupil achievements in Mathematics, and to provide some analytical map of the mathematics achievement in the state. The choice of Penang was to exacerbate ethnic and social divergence given the aforementioned social and political structures and the segregation within the primary schools. Whilst Malaysia is a diverse ethnic mix, Penang has particular characteristics of being significantly culturally Chinese within a tri-cultural community. We were interested in examining whether there were, for example differences in levels of achievement between Malay, Chinese or Tamil schools, and whether the social mix and geographical location played any role. Of course in order to undertake any detailed and robust parametric statistical analysis of such effects, we need to have sustainable assumptions that there actually are effects to identify otherwise, we may find we attribute causation to otherwise random or error effects.

Data was obtained from the Penang State Education Department. At the end of Year Six (age 11 – 12), all pupils sit for the Primary School Achievement Test (UPSR), performance in which will decide which secondary school they go to the following year. The UPSR is an examination designed as an internal national qualification to mark the completion of primary school. The subjects tested in UPSR include Bahasa Malaysia, English language, Mathematics, and Science for students in national schools. Students at national-type primary schools also sit for Chinese or Tamil language. We also obtained the number of pupils in each school in receipt of government financial assistance. For each school we were able to obtain demographic data (size, type and location of school), achievement data (number of pupils sitting the UPSR and achieving each grade) and the number receiving government financial assistance. Analysis of data was undertaken at a school not a pupil level since we were only able to obtain the data in this aggregated form. Data contained information on name, location and ethnicity of school, total number of pupils, number of pupils receiving financial assistance, number of pupils who obtained each of the grades A to E in Mathematics. (Grades A, B and C are considered passes and D and E are failures).

### The use of data

It is important to stress that this is the first time such data has all been gathered together in one place and subjected to analysis. In this study we are examining a bounded geographical area, however, within that boundary, we can see considerable heterogeneity. It is our contention in this paper, that we gain little from attempting to utilize seemingly “hard” parametric statistics simply because the data do not meet the underlying assumptions for such a statistical analysis. It would help us little – and indeed be a positivist distraction - were we to try to calculate means, variations and other test statistics and look for significance. (See also Gorard, 2010 for a stronger argument). Consider the two key variables of poverty and achievement in Figure 1.

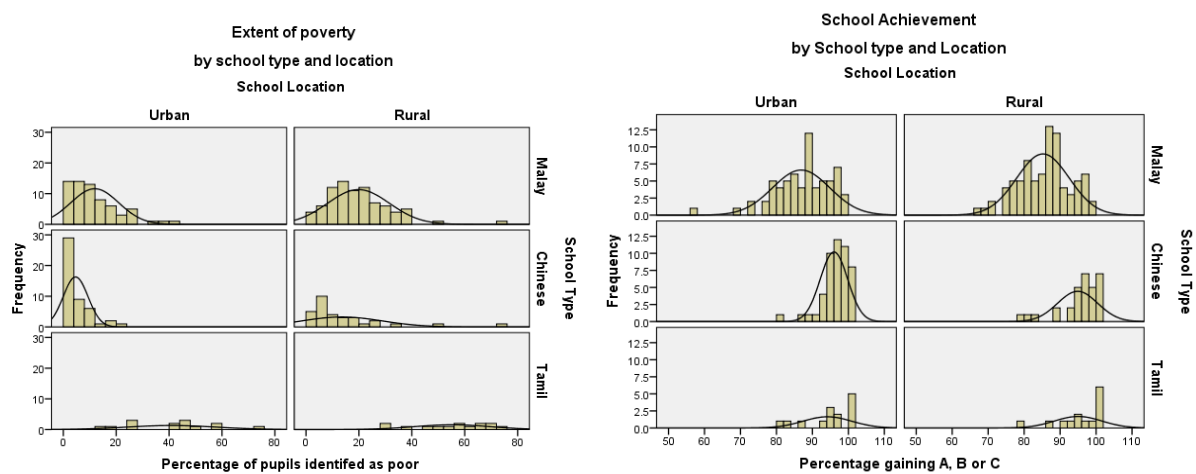

Figure 1: Poverty and Mathematics achievement in Penang 2012 (Histogram)

It would seem difficult not to conclude on the basis of this data representation that underlying data appears to contravene normality assumptions, making most parametric analysis impossible. Also patterns of poverty and achievement within each ethnic school group appears to be quite different as we can see in Figure 2.

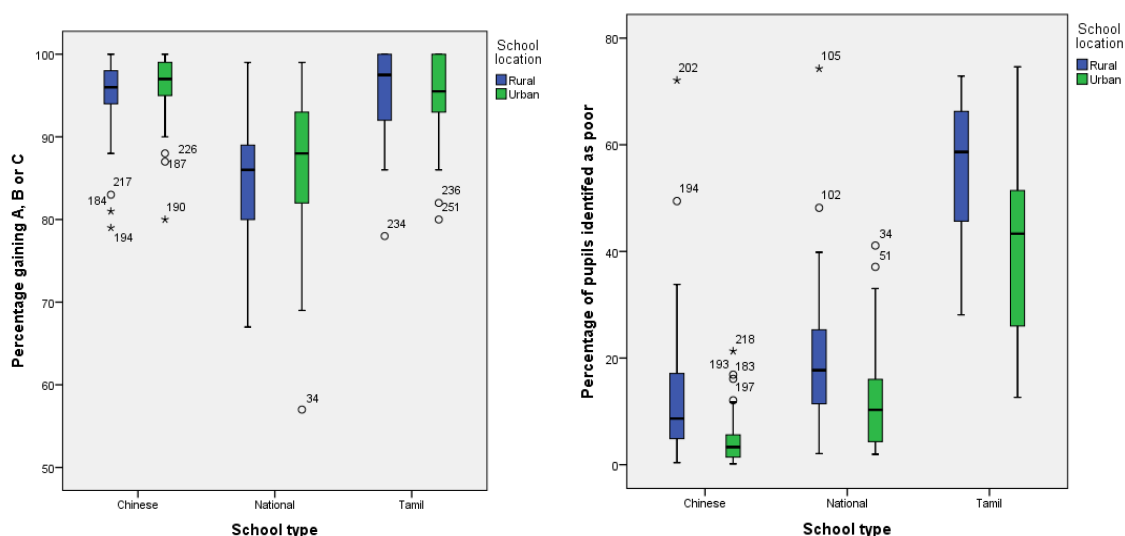

Figure 2: Poverty and Mathematics achievement in Penang 2012 (Box plots)

Again assumptions of normality are not substantiated here, but we do not need to calculate significance levels etc. in order to see something about the distributions of levels of poverty and mathematics achievement.

This is in many ways not particularly surprising, as both variables are politically and socially constructed by government policy, rather than representing some natural phenomenon. If levels of poverty in the school and mathematics achievement were inversely related, we might expect to see this reflected in the box plots. Whilst to some extent this is the case for Malay and Chinese schools, it is clearly not the case for Tamil schools. Failure on the UPSR is similarly distributed as in Figure 3.

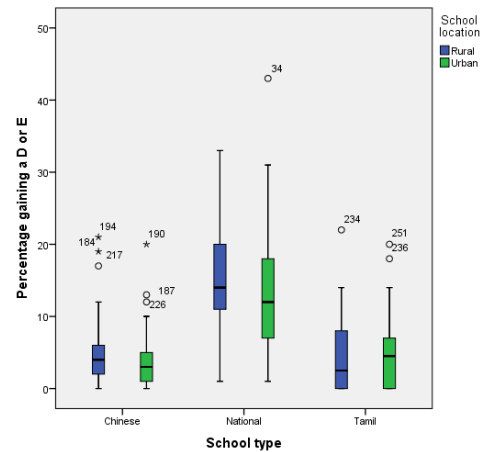

Figure 3: Failure grades

### INFLUENCE OF ETHNICITY AND POVERTY

We might however look at rank correlation coefficients for any indication of possible strength of association. All three types of school show a low correlation between mathematics achievement and percentage of students on financial assistance.

Malay (n=148) = -0.336      Chinese (n=79) = -0.152      Tamil (n=28) = +0.063

Whilst the correlation was not significant for Chinese and Tamil National-type schools it was significantly negative for (Malay) National schools indicating there may indeed be evidence of greater levels of association within the Malay schools than Chinese or Tamil, with Tamil schools having virtually no association between levels of poverty and mathematics achievement – which fits the picture presented in Figures 1 and 2. We did run a Kruskal-Wallis test to examine whether the level of mathematical achievement across the three ethnic groups represented different underlying distributions. A p value of <0.000, suggests the distribution of mathematics achievement across the three groups was different. Figures 1 and 2 illustrate the school UPSR pass rates. The Malay National schools ranged from 70% – 100% passes with scores symmetrically distributed within that range. Both the National-type Chinese and Tamil schools ranged from 80 – 100% with only two such schools scoring below 80% and Figure 2 shows the skew toward the higher pass rates. This is more notable when taken into consideration with the levels of poverty in these schools. The extent of poverty at school level can be seen in Figure 4.

School type	>30% financial assistance	>70% financial assistance
Malay (148)	17	1
Chinese (79)	3	1
Tamil (28)	22	3

Figure 4: Extent of school level poverty within Penang schools

For the three types of schools there appears to be three different mechanisms at work for the effect of levels of poverty on achievement.



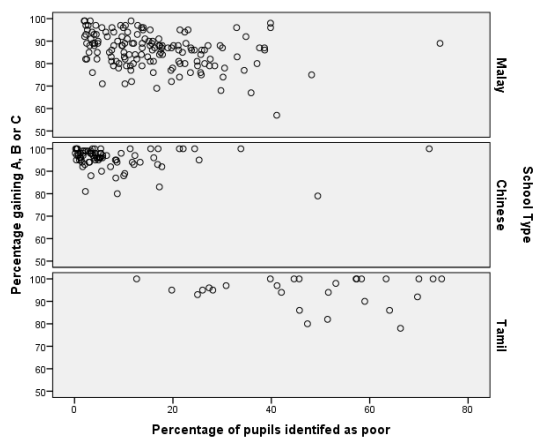

Figure 5: Scatterplot of poverty and achievement by school type

In the **Malay National schools**, there is a weak negative association between levels of poverty and achievement.

In the **Chinese National schools**, levels of poverty are low and levels of achievement very high, leading to little discrimination.

In the **Tamil National schools**, levels of poverty are spread between 13% and 75%, yet this has virtually no effect on the high levels of achievement.

In all three types of school, there is a tendency that schools with a high percentage of pupils receiving financial assistance are located in rural areas – this is perhaps not surprising. Of the Malay national schools 83 (55%) were located in rural parts of the state (hence termed “rural schools”) while 66 schools (45%) were in urban areas. Of the national-type Chinese schools 31 (39%) were located in rural parts of the state, while 49 (61%) were in urban areas. Half of the national-type Tamil schools (14) were located in rural parts of the state, while the other half (14) were in urban areas. Generally, there does not appear to be a pattern of effects between the location of the schools and their mathematics achievement, as can be observed in Figure 2 apart possibly from the Tamil schools where even schools in rural areas with high level of pupils in poverty still achieve high pass rates.

## DISCUSSION AND FUTURE RESEARCH

Our analysis in this early phase of the research has been deliberately low-key because of our contention that for such localised school data detailed statistical analysis is inappropriate and unjustified. What we have demonstrated is how we might use more non-parametric exploratory approaches to data representation and analysis in order to examine some possible underlying mechanisms in educational systems.

The first finding is the similarity between overall results in rural and urban schools. Some rural schools with high levels of poverty are obtaining high levels of passes – particularly in the Tamil communities. And this poses questions for the next stage of research.

Whilst our data provided us with only school level variables, we are unable to identify any pupil level effects. Nor do we know anything of the familial levels of poverty in each of the three types of school. All types of schools appear to have a heterogeneous spread of poverty levels, with only Chinese Urban schools appearing to be quite homogeneous with low levels of poverty. As of yet we have no data on school choice mechanisms, and this is a further avenue of future research.

What is also worthy of further research, and is something we are now examining through qualitative approaches, are those schools seen as outliers in Figures 2 and 3. For example, one rural Malay National school has a high percentage of pupils receiving financial assistance and obtained 98.5% passes, while another with a sizeable number of pupils on financial assistance obtained the lowest pass rate (57%). Of the three national-type Chinese schools with a high proportion of pupils receiving financial assistance, two obtained 100% passes while the other obtained 79% passes and is the lowest performing national-type Chinese school, all of which were located in rural area. For the national-type Tamil schools, most of the schools which obtained 100% passes had a high proportion of pupils receiving financial assistance. Two of these are cases for further research as one has the highest percentage of pupils receiving financial assistance but obtained 100% passes and the other has a sizeable number of pupils receiving financial assistance but performed the least well (78% passes).

This stage of the research has identified schools which are bucking the national trend and in which pupils are apparently succeeding (or failing) against the odds (Bempechat, 1998), but also where there are clear differences in levels of achievement in otherwise similar contexts. The next two stages of this research will be a more focused examination of outlier schools plus a characterisation of mathematical pedagogical practices in each ethnic type of school.

### **Acknowledgment**

Our demographic and educational data in this paper were obtained from the Penang State Government – to whom we are grateful.

### **References**

- Bempechat, J. (1998). *Against the odds. How “at-risk” students exceed expectations*. San Francisco: Jossey Bass.
- Gates, P., & Guo, X. (2013). How British-Chinese parents support their children: a view from the regions. *Educational Review*. doi: 10.1080/00131911.2013.768958
- Gorard, S. (2010). All evidence is equal: the flaw in statistical reasoning. *Oxford Review of Education*, 36(1), 63-77.
- Kitchen, R., DePree, J., Celdon-Pattichis, S., & Brinkerhoff, J. (2007). *Mathematics education at highly effective schools that serve the poor*. New York: Lawrence Erlbaum.
- Malaysian Ministry of Education. (2013). *Malaysian national education blueprint, Kuala Lumpur*. <http://www.moe.gov.my/userfiles/file/PPP/Preliminary-Blueprint-Eng.pdf>.

# MAKING SENSE OF THE MULTIPLE MEANINGS OF 'EMBODIED MATHEMATICS LEARNING'

Susan Gerofsky

University of British Columbia

*The theme of 'embodiment' has become an important approach in current mathematics education research, growing in significance from the mid-1990s onward. However terminology of 'body' and 'embodiment' is used to signal multiple, widely varying meanings in this research. Studies are grounded in a number of radically different theoretical bases, with the result that mathematics education researchers do not necessarily mean the same thing at all when they refer to 'body', 'embodiment' and 'embodied mathematics learning'. In this theoretical paper, the author offers a framework for interpreting these polysemous terms in relation to their theoretical groundings, with examples from the mathematics education literature.*

## **MULTIPLE MEANINGS OF 'EMBODIMENT' AND THEIR SOURCES**

In this conceptual paper, I offer a snapshot of the current research in embodied mathematics education. I develop an account of the historical context, disciplinary origins, research aims and meanings accruing to 'body' in the various strands that make up this research, and then undertake a brief annotated bibliography that attempts to characterize a selection of studies in these terms. Many papers in this area will be grounded in several foundational strands, but I posit that there will be one strand that predominates. This sense-making process may serve as a guide to researchers working in embodiment research in our field and offer a first attempt at a conceptual framework not previously available in this area.

## **HISTORICAL BACKGROUND: EMBODIMENT AS A SIGNIFICANT RESEARCH STRAND IN MATHEMATICS EDUCATION**

In recent years, many mathematics educators have begun to challenge Platonic, Cartesian and Bourbakian assumptions that positioned mathematics (and mathematics teaching and learning) as wholly abstract, mental and disembodied (Roth 2010; Radford 2002; and many others). Such assumptions, based on the premise of a human mind-body split and of the transcendence of mind over body, were predominant in Western philosophy from the time of Plato (circa 500 BCE) till the mid-20<sup>th</sup> century. Since that time, there has been philosophical opposition to the postulate of mind as separate from, and superior to body. Philosophical challenges to the mind-body split have accelerated since the early 1980s, and mathematics education research has taken this up as a significant basis for research since the mid-1990s.

In many ways, mathematics and mathematics education offer an important space for the consideration of embodiment and conceptualization, since mathematics has been considered the *sine qua non* of abstract idealization since Plato's time. For example, in

a famous passage in Plato's *Meno* (1976), Socrates teaches an unschooled slave boy about what we would identify as irrational numbers, ostensibly by activating a memory of a realm of perfect, disembodied mathematical Forms via Socratic questioning. From Ancient Greece to the Bourbaki school of mathematicians in the mid-20<sup>th</sup> century, who famously banned geometric sketches of triangles as excessively embodied (Yaglom 1981), mathematics has been a prime exemplar of non-bodily ways of knowing.

For this reason, mathematics has also been an important area for bringing embodiment back into theories of cognition, learning and representation; if mathematical knowing of abstract concepts can be convincingly shown to involve 'body', then so can almost any other realm of human knowledge.

Within mathematics education research, the degree of inclusion (or exclusion) of 'body' in theories of mathematical knowing has the potential to affect theories of mathematics learning, pedagogy, learning materials, curriculum, classrooms and learning spaces, assessment, teacher-student relationships and many other facets of the teaching and learning of mathematics. A fundamental paradigm shift from the assumption of disembodied to embodied ways of knowing in research can change almost everything about the theory and practices of mathematics education, and for this reason, the turn towards 'body' is an important one.

## **EMBODIMENT AS A CONTEMPORARY RESEARCH THEME ACROSS DISCIPLINES**

Since the mid-20<sup>th</sup> century, theorists in all disciplines have begun to reconsider and reframe concepts of 'body' and 'embodiment', and to move away from Cartesian mind-body dualism. This conceptual shift has accelerated since 1980, and has affected nearly every field of intellectual endeavour and praxis (for example, see Canning 1999). We might well ask why this is happening in our era – why our cultural preoccupation with embodiment at this time? Questions about the reasons that particular intellectual trends, schools of thought or new ideas arise at a particular time and place are seldom resolved to everyone's satisfaction, even in retrospect, since so many convergences (political, economic, academic, technological, social, religious, etc.) might account for them. I have written elsewhere (Gerofsky forthcoming) one way of understanding 'why embodiment now?', based in McLuhan's theoretical approaches to culture and technology (McLuhan & McLuhan 1988), but it is beyond the scope of this paper to discuss this here.

Universes of discourse around embodiment vary widely. As researchers in mathematics education, this poses some dilemmas. Our field has traditions of borrowing, adapting, transforming and re-envisioning theories drawn from widely heterogeneous origins. Mathematics educators often re-make these theories in surprising and generative new ways in adapting them for new purposes. In this process, conflicting meanings may arise from shared terminology. I will examine this polysemy here, looking at theoretical groundings, research aims and conceptualizations of 'body'

that collocate in a number of prototypical research approaches to embodied mathematics learning.

### **ASPECTS OF EMBODIED RESEARCH STRANDS: THEORETICAL GROUNDING, RESEARCH AIMS, CONCEPTUALIZATION OF ‘BODY’**

Embodiment research in mathematics education to date has been grounded in the following *theoretical domains*: philosophy, semiotics, cultural studies, linguistics/cognitive linguistics, computer science, cognitive neuroscience, education/curriculum and pedagogy, gesture studies and fine and performing arts.

To clarify these terms: philosophy refers here primarily to Western traditions of classical to Modernist philosophical thought, but may also include philosophical traditions outside the Western canon. Semiotics arose in the 20<sup>th</sup> century to analyze cultural phenomena via a consideration of signs and their signification, and is closely connected with structuralism, with roots in linguistics mathematics, philosophy, anthropology, and literary criticism. Cultural studies is the postmodern domain of theory that situates knowledge in the particularities of bodies, cultures, places, genders, classes, ‘races’, ethnicities, ages, abilities, etc., often focusing on the relationships between particular ways of knowing based in embodied experiences and the ways these knowledges play out in power structures like colonialism and political struggles.

Linguistic studies language, and cognitive linguistics focuses on the relationship between language and the human mind and conceptualization. Computer science includes theories and research in HCI (human-computer interactions) and the ‘cognitively ergonomic’ design of more and less bodily engaged, multisensory interactions between learners and applications. Cognitive neuroscience focuses on the brain, neurological systems and other biological systems as substrates for learning. Curriculum and pedagogy in education focus on understanding and improving teaching and learning, inside and outside of schools. Gesture studies is a new field concentrating on the use of hands and other parts of the body for primarily communicative purposes. Fine and performing arts interact with mathematics/ math education as media for expression of mathematical relationships via performances (theatre, dance, storytelling, music, film) and art objects (sculpture, painting, drawing, textile arts).

*Research aims* of embodiment studies in mathematics education include the intention to create theory, to understand how people learn, to design better tools and systems that support learning, to design better pedagogy, and to create art.

Studies *conceptualize ‘body’* in the following ways: body as source of embodied metaphors; as diverse, culturally mediated artefact; as individual and/or collective human bodies; as part of an ecosystem in the actual world; as adjunct to virtual worlds; as an autonomic system of brain, neurological system and ‘peripherals’; as a physical body comprising core, limbs and head; as part of the physical world of performance; as

source of evidence of unconscious processes; as a resource for conscious pedagogy; and as something that should be suppressed or expressed.

The three lists above (theory, aims, concepts of ‘body’) are clearly somewhat arbitrary and neither exhaustive nor mutually exclusive. They are based in the extant work in embodied mathematics education, and reflect the range of approaches researchers have taken to this point.

Elements of the three lists tend to collocate to form a number of strands of embodiment research in mathematics education, described in the following section. It is important to note that particular studies and papers very often combine several of these strands, as researchers strive to bring together heterogeneous sources of work on embodiment in ways that inform mathematics learning research.

### HOW THEORY, AIMS AND CONCEPT OF BODY COLLOCATE IN RESEARCH

The chart (Table 1) below brings together elements from the lists above in an effort to characterize predominant contemporary approaches to embodied learning in mathematics. It is followed by a brief section characterizing a sampling of research papers in terms of the strands identified here.

<b>Theoretical grounding</b>	<b>Research aims</b>	<b>Bodies as...</b>
Philosophy, often including phenomenology	To create theory	Body as something that should be expressed.
Semiotics	To create theory; to understand how people learn	Individual or collective bodies interacting as part of an ecosystem in the actual world
Cultural theory	To create theory	Bodies as diverse, culturally-mediated artefacts
Linguistics/ cognitive linguistics	To create theory	Bodies as sources of embodied metaphors
Computer science/ cognitive science	To design better tools and systems that support learning	Body as adjunct to virtual worlds. Bodies interacting as part of an ecosystem in the actual world. Bodies as sources of embodied metaphors.
Cognitive neuroscience	To understand how people learn	Individual bodies as brains, neurological systems and ‘peripherals’. Bodies as sources of evidence of unconscious cognitive processes.
Curriculum and pedagogy	To create theory; to understand how people learn; to design better pedagogy	Individual & collective bodies interacting as part of an ecosystem in the actual world. Bodies as core, limbs, head, available as a resource for conscious pedagogy. Bodies as something that can be expressed or suppressed.
Gesture studies	To create theory; to understand how people	Individual or collective bodies as core, limbs, head as a source of evidence of

	learn and communicate	unconscious processes. Bodies as something that should be expressed.
Fine and performing arts	To create (mathematical) art	Individual and collective bodies as part of the material world of performance and art-making. Bodies as something that should be expressed.

Table 1

A sample of influential studies can then be characterized by combinations of these research strands:

- Philosophy (Campbell & Dawson 1995; Roth 2010; Roth & Thom 2009 (incorporating pedagogy))
- Semiotics (Presmeg 2006; Radford 2002; Radford 2009 (incorporating gesture theory); Radford, Bardini, Sabena, Diallo, & Simbagoye, 2005; Radford, Edwards & Arzarello 2009; Steinbring 2006 (all incorporating pedagogy))
- Cultural theory (De Freitas 2008; De Freitas & Sinclair 2012 (also incorporating gesture studies and pedagogy); Lave 1997; Mowat & Davis 2010, and Sinclair, De Freitas & Ferrera 2013 (incorporating pedagogy))
- Cognitive linguistics (Edwards 2009 (incorporating gesture studies); Lakoff & Núñez 2000; Nemirovsky & Ferrera 2012 (incorporating pedagogy); Núñez, Edwards & Matos 1999 (incorporating pedagogy))
- Computer science/ cognitive science (Abrahamson 2009; Abrahamson & Trninic 2011; Howison, Trninic, Reinholz & Abrahamson 2011; Jackiw & Sinclair 2009; Kaput, Noss & Hoyles 2002; Sinclair & Gol Tabaghi 2010; Winn 2003 (all incorporating pedagogy))
- Cognitive neuroscience (Campbell 2010)
- Curriculum and pedagogy (Arzarello, Robutti & Bazzini 2005; Drijvers et al 2010 (incorporating computer science); Goldin & Kaput 1996; Nemirovsky et al 2004; Noble, Nemirovsky, Wright & Tierney 2001; Sriraman & English 2005; Stevens & Hall 1998; Tall 2004, 2006)
- Gesture studies (Alibali & Nathan 2012; Cook, Mitchell & Goldin-Meadow 2008; Gerofsky 2010; Hostetter & Alibali 2008; Roth 2001 (incorporating philosophy and pedagogy))
- Fine and performing arts (Gadanidis & Borba 2008; Gadanidis, Hoogland & Sedig 2003; Healy & Sinclair 2007; (all incorporating pedagogy))

## CONCLUDING REMARKS

This initial work to characterize and exemplify distinctions in embodied mathematics education research identifies a number of strands based on theoretical grounding, research aims and conceptualization of ‘body’. While necessarily provisional, imperfect and incomplete, it is hoped that this schema will offer a useful way for researchers to make sense of this heterogeneous, polysemous new area of research.

## References

- Abrahamson, D. (2009). Embodied design: Constructing means for constructing meaning. *Educational Studies in Mathematics*, 70(1), 27-47.
- Abrahamson, D., & Trninic, D. (2011). Toward an embodied-interaction design framework for mathematical concepts. In P. Blikstein & P. Marshall (Eds.), *Proceedings of the 10<sup>th</sup> Annual Interaction Design and Children Conference (IDC 2011)* (pp. 1-10). Ann Arbor, MI: ACM.
- Alibali, M. W., & Nathan, M. J. (2012). Embodiment in mathematics teaching and learning: Evidence from learners' and teachers' gestures. *Journal of the Learning Sciences*, 21(2), 247-286.
- Arzarello, F., Robutti, O., & Bazzini, L. (2005). Acting is learning: focus on the construction of mathematical concepts. *Cambridge Journal of Education*, 35(1), 55-67.
- Campbell, S. R. (2010). Embodied minds and dancing brains: New opportunities for research in mathematics education. In *Theories of mathematics education* (pp. 309-331). Berlin: Springer.
- Campbell, S., & Dawson, A. J. (1995). Learning as embodied action. In *Exploiting mental imagery with computers in mathematics education* (pp. 233-249). Berlin: Springer.
- Canning, K. (1999). The body as method? Reflections on the place of the body in gender history. *Gender & History*, 11(3), 499-513.
- Cook, S. W., Mitchell, Z., & Goldin-Meadow, S. (2008). Gesturing makes learning last. *Cognition*, 106(2), 1047-1058.
- De Freitas, E. (2008). Mathematics and its other: (Dis)locating the feminine. *Gender and Education*, 20(3), 281-290.
- De Freitas, E., & Sinclair, N. (2012). Diagram, gesture, agency: Theorizing embodiment in the mathematics classroom. *Educational Studies in Mathematics*, 80(1-2), 133-152.
- Drijvers, P., Kieran, C., Mariotti, M. A., Ainley, J., Andresen, M., Chan, Y. C., & Meagher, M. (2010). Integrating technology into mathematics education: Theoretical perspectives. In *Mathematics education and technology-Rethinking the terrain* (pp. 89-132). Springer US.
- Edwards, L. D. (2009). Gestures and conceptual integration in mathematical talk. *Educational Studies in Mathematics*, 70(2), 127-141.
- Gadanidis, G., & Borba, M. (2008). Our lives as performance mathematicians. *For the Learning of Mathematics*, 28(1), 44-51.
- Gadanidis, G., Hoogland, C., & Sedig, K. (2003). Mathematics as story. In *Proceedings of mathematics as story: A symposium on mathematics through the lenses of art and technology* (pp. 128-135). Toronto, ON: Fields Institute.
- Gerofsky, S. (2010). Mathematical learning and gesture: Character viewpoint and observer viewpoint in students gestured graphs of functions. *Gesture*, 10(2-3), 2-3.
- Gerofsky, S. (in press). Democratic access to mathematics through embodied ways of knowing. In L. English & D. Kirshner (Eds.), *Handbook of international research in mathematics education* (3<sup>rd</sup> ed., Chapter 12). Abingdon, UK: Taylor & Francis.



- Goldin, G. A., & Kaput, J. J. (1996). A joint perspective on the idea of representation in learning and doing mathematics. In L. Steffe & P. Nesher (Eds.), *Theories of mathematical learning* (pp. 397-430). Mahwah, NJ: Lawrence Erlbaum Associates.
- Healy, L., & Sinclair, N. (2007). If this is our mathematics, what are our stories? *International Journal of Computers for Mathematical Learning*, 12(1), 3-21.
- Hostetter, A. B., & Alibali, M. W. (2008). Visible embodiment: Gestures as simulated action. *Psychonomic Bulletin & Review*, 15(3), 495-514.
- Howison, M., Trninic, D., Reinholz, D., & Abrahamson, D. (2011, May). The mathematical imagery trainer: From embodied interaction to conceptual learning. In *Proceedings of the SIGCHI Conference on Human Factors in Computing Systems* (pp. 1989-1998). ACM.
- Jackiw, N., & Sinclair, N. (2009). Sounds and pictures: Dynamism and dualism in dynamic geometry. *ZDM*, 41(4), 413-426.
- Kaput, J., Noss, R., & Hoyles, C. (2002). Developing new notations for a learnable mathematics in the computational era. In D. English (Ed.), *Handbook of international research in mathematics education* (pp. 51-75). London: Lawrence Erlbaum Associates.
- Lakoff, G., & Núñez, R. E. (2000). *Where mathematics comes from: How the embodied mind brings mathematics into being*. New York: Basic Books.
- Lave, J. (1997). The culture of acquisition and the practice of understanding. In D. Kirshner & J. A. Whitson (Eds.), *Situated cognition: Social, semiotic, and psychological perspectives* (pp. 63-82). Mahwah, NJ: Lawrence Erlbaum Associates.
- McLuhan, M., & McLuhan, E. (1988). *Laws of media: The new science*. Toronto: University of Toronto Press.
- Mowat, E., & Davis, B. (2010). Interpreting embodied mathematics using network theory: Implications for mathematics education. *Complicity: An International Journal of Complexity and Education*, 7(1).
- Nemirovsky, R., Borba, M., Dimattia, C., Arzarello, F., Robutti, O., Schnepf, M., & Scheffer, N. F. (2004). [PME special issue: Bodily activity and imagination in mathematics learning.] *Educational Studies in Mathematics*, 57(3), 303-321.
- Nemirovsky, R., & Ferrara, F. (2009). Mathematical imagination and embodied cognition. *Educational Studies in Mathematics*, 70(2), 159-174.
- Noble, T., Nemirovsky, R., Wright, T., & Tierney, C. (2001). Experiencing change: The mathematics of change in multiple environments. *Journal for Research in Mathematics Education*, 32(1), 85-108.
- Núñez, R. E., Edwards, L. D., & Matos, J. F. (1999). Embodied cognition as grounding for situatedness and context in mathematics education. *Educational Studies in Mathematics*, 39(1-3), 45-65.
- Plato. (1976). *The Meno*. (G.M.A. Grube, Trans.). Indianapolis, IN: Hackett Publishing.
- Presmeg, N. C. (2006). Research on visualization in learning and teaching mathematics. In A. Gutiérrez & P. Boero (Eds.), *Handbook of research on the psychology of mathematics education* (pp. 205-235). Rotterdam, The Netherlands: Sense Publishers.

- Radford, L. (2002). The seen, the spoken and the written: A semiotic approach to the problem of objectification of mathematical knowledge. *For the Learning of Mathematics*, 22(2), 14-23.
- Radford, L. (2009). Why do gestures matter? Sensuous cognition and the palpability of mathematical meanings. *Educational Studies in Mathematics*, 70(2), 111-126.
- Radford, L., Bardini, C., Sabena, C., Diallo, P., & Simbagoye, A. (2005). On embodiment, artifacts, and signs: A semiotic-cultural perspective on mathematical thinking. In H. L. Chick & J. L. Vincent (Eds.), *Proc. 29<sup>th</sup> Conf. of the Int. Group for the Psychology of Mathematics Education* (Vol. 4, pp. 129-136). Melbourne, Australia: PME.
- Radford, L., Edwards, L., & Arzarello, F. (2009). Introduction: beyond words. *Educational Studies in Mathematics*, 70(2), 91-95.
- Roth, W. M. (2001). Gestures: Their role in teaching and learning. *Review of Educational Research*, 71(3), 365-392.
- Roth, W. M. (2010). Incarnation: Radicalizing the embodiment of mathematics. *For the Learning of Mathematics*, 30(2), 8-17.
- Roth, W. M., & Thom, J. S. (2009). Bodily experience and mathematical conceptions: From classical views to a phenomenological reconceptualization. *Educational Studies in Mathematics*, 70(2), 175-189.
- Sinclair, N., de Freitas, E., & Ferrara, F. (2013). Virtual encounters: the murky and furtive world of mathematical inventiveness. *ZDM*, 45, 1-14.
- Sinclair, N., & Gol Tabaghi, S. (2010). Drawing space: Mathematicians' kinetic conceptions of eigenvectors. *Education Studies in Mathematics*, 74(3), 223-240.
- Sriraman, B., & English, L. D. (2005). Theories of mathematics education: A global survey of theoretical frameworks/trends in mathematics education research. *ZDM*, 37(6), 450-456.
- Steinbring, H. (2006). What makes a sign a mathematical sign? An epistemological perspective on mathematical interaction. *Educational Studies in Mathematics*, 61(1-2), 133-162.
- Stevens, R., & Hall, R. (1998). Disciplined perception: Learning to see in technoscience. In M. Lampert & M. Blunk (Eds.), *Talking mathematics in school: Studies of teaching and learning* (pp. 107-149). Cambridge, UK: Cambridge University Press.
- Tall, D. (2004). Building theories: The three worlds of mathematics. *For the Learning of Mathematics*, 24(1), 29-32.
- Tall, D. (2006). A theory of mathematical growth through embodiment, symbolism and proof. In F. Pluvinage & A. Kuzniak (Eds.), *Annales de Didactique et de Sciences Cognitives* (Vol. 11, pp. 195-215). Strasbourg: IREM Strasbourg.
- Winn, W. (2003). Learning in artificial environments: Embodiment, embeddedness and dynamic adaptation. *Technology, Instruction, Cognition and Learning*, 1(1), 87-114.
- Yaglom, I. M. (1981). Elementary geometry, then and now. In C. Davis, B. Grünbaum, & F. A. Sherk (Eds.), *The geometric vein* (pp. 253-269). New York: Springer.

# USING ICT IN TEACHING A SPECIFIC MATHEMATICS CONCEPT: GRAPHS OF LOGARITHMIC FUNCTIONS

Seyum Tekeher Getenet, Kim Beswick

University of Tasmania

*This paper describes the use of the free software, to teach graphs of logarithmic functions at an Ethiopian College of Teacher Education. Data comprised two video-recorded lessons and interview data provided by a mathematics teacher educator, and three primary school mathematics pre-service teachers who were in the class of learners. Pre-service teachers using Microsoft Mathematics readily understood and described properties of logarithmic functions as the bases varied. The study highlights the importance of illustrating the use of particular software to teach specific mathematics concepts.*

## INTRODUCTION

The use of Information Communication Technology (ICT) in teaching can lead to significant positive pedagogical outcomes (e.g., Goos, Galbraith, Renshaw & Geiger, 2003; Pierce & Stacey, 2010)). Such findings have motivated universities, colleges, and school teachers to integrate ICT into teaching to achieve better learning outcomes. ICT can support constructivist pedagogies, whereby students use technology to explore and to reach an understanding of concepts (Chee, Horani, & Daniel, 2005). As a result, integration of ICT in teaching is a key component of educational reform agenda to enhance the quality of education across the world. For example, countries in Africa strongly endorse and support ICT as an essential component of innovative student-centred pedagogy (e.g., Hennessy, Harrison, & Wamakote, 2010).

The current Ethiopian school curriculum and education system have been characterised as low in quality (e.g., Desta, Chalchisa, Mulat, Berihun, & Tesera, 2009). There is, therefore, considerable support throughout the system, including in the higher education sector, to improve quality. Efforts have been made to encourage teachers at all levels to integrate ICT in their teaching. These include national initiatives that encourage teacher educators to use ICT in their teaching as a means to improve the quality and equity of education, particularly for science and mathematics teaching (Ministry of Education, 2010). This study aligns with that effort in exploring how an Ethiopian mathematics teacher educator used *Microsoft Mathematics* (MSM) to teach the graphs of logarithmic functions.

## ICT IN LEARNING MATHEMATICS

Although the integration of ICT in teaching has generic aspects as described, for example by Koehler and Mishra (2005), there is also a need to consider the use of technology in particular subjects such as mathematics and indeed in relation to specific

mathematics content (Holmes, 2009). In addition, the affordances of specific technological tools influence possible teaching approaches and appropriate pedagogies (Kennewell, 2001).

There is a great deal of mathematics specific software available (Hohenwarter, Hohenwarter, & Lavicza, 2009) and ICT-based learning environments can provide opportunities for active learning and enhanced student engagement (Chee, Horani, & Daniel, 2005). For instance, simulations and animations enable students to vary a selection of input parameters, observe how each affects the system under study, and interpret the output results through an active process of hypothesis-making, and ideas testing. They can explore combinations of factors and observe their effects on the evolution of the system under study. Mathematics specific software includes Geogebra, MSM, Maxima, STELLA, and spread sheets. MSM is free and can help students to achieve an understanding of a range of mathematical concepts. It can help students to visualise the effects of changed parameters. The MSM interface allows for solving problems with minimal syntax instruction (Nord & Nord, 2011) and facilitates animation. The use of the 'Animate' command found within MSM can possibly aid discovery-style lessons (Morrison, Tversky, & Betrancourt, 2000). It offers, for example, visualisation of shapes of graphs of families of logarithmic functions by learners input of bases,  $b$ , between  $b > 1$ , and  $0 < b < 1$ .

In Ethiopia, financial constraints mean that freely available software is preferable. MSM was selected for this study because it fitted this criterion and also had capabilities thought to be useful in enhancing the teaching of mathematical ideas such as logarithmic functions.

### **Logarithmic functions**

Functions, including logarithmic, form a major part of school mathematics but are challenging to teach (Makgakga & Sepeng, 2013). Kenney and Kastberg (2013) found that students struggled greatly with the concept of logarithmic functions and sketching their corresponding graphs, and with the processes needed for working with logarithmic equations. Superficially, the graphs of all logarithmic function can easily be overgeneralised as similar shapes regardless of varied bases,  $b$  (e.g., Chua & Wood, 2005). In this regard Goos, Galbraith, Renshaw and Geiger (2003) indicated that the introduction of technology resources into mathematics classrooms promises to create opportunities for enhancing students' learning through active engagement. In addition, a study by Abu-Naja (2008) showed that students learn more effectively the characteristic properties of families of functions using technology than without using any ICT. This study, therefore, focuses on the use a particular software resource, MSM, to teach a specific mathematical topic, namely graphs of logarithmic functions.

## METHOD

### The Study

The research site was the department of mathematics in an Ethiopian college of teacher education. Primary mathematics pre-service teachers (PSTs) are required to attend basic mathematics and professional courses in a 3-year program. Mathematics courses include Fundamental Concepts of Algebra, Plane Geometry, Basic Mathematics I and II, and Introduction to Calculus. The professional courses included Methods of Teaching Mathematics.

### Participants

Participants were PSTs finishing their first year in the program. They were enrolled in Basic Mathematics II, the content of which includes graphs of logarithmic functions. Most were aged between 18 and 24 years. All 29 (18 males and 11 females) participated in the observation part of the study. A mathematics teacher educator who had participated in a professional learning program process for a total of 3 months, aimed at encouraging the use of ICT in initial teacher education also participated.

### Procedure

Two video-recorded lessons totalling 2 hours and involving the use of MSM to teach logarithmic functions were taught by the teacher educator. Once the PSTs were familiar with the menus and toolbars of the software, they learned how to graph logarithmic functions. They were then asked to work in groups of three or four to illustrate properties of graphs of logarithmic functions. The questions shown in Figure 1 were provided to guide their work.

- 1) Sketch the graphs of the following logarithmic functions:
 

a. $f(x) = \log_2 x$	d. $f(x) = \log_{\frac{2}{3}} x$
b. $f(x) = \log_5 x$	e. $f(x) = \log_{\frac{1}{2}} x$
c. $f(x) = \log_{\frac{7}{2}} x$	
- 2) Describe the shapes of the graphs when  $b > 1$ , and  $0 < b < 1$
- 3) Describe properties of the graphs listed in question 1
  - a. Common properties
  - b. Describe the graphs when  $x > 1$ , and  $0 < x < 1$ ,  $x = 1$

Figure 1: Questions explored using MSM

Following the two lessons, semi-structured, audio-recorded, individual interviews were conducted with three PSTs (two males and one female) and the teacher educator. The teacher educator was asked for his views of the lessons he taught with MSM and about his previous teaching of graphs of logarithmic functions (such as how the lesson engaged learners?). PSTs were asked for their opinions of the MSM integrated lessons (e.g., How engaging the lesson was? What aspects of the lesson helped them to learn?).

## Data analysis

Interview data from PSTs' and the teacher educator were analysed to identify themes (Creswell, 2009) relevant to using MSM to teach graphs logarithmic functions. The video-recorded lessons were analysed by watching and taking notes (Stigler & Hiebert, 1997) emphasising those parts relevant to the questions shown in Figure 1. Consistent with the advice of Barron and Engle (2007), the analysis emphasised aspects of ICT use known to be relevant, such as how the students interacted with MSM, specifically their use of the tools it provided, and how they worked to make sense of their graphs.

## RESULTS

### The teacher educator's previous approach to teaching logarithmic functions

The teacher educator described two methods he had previously used to teach sketching graphs of logarithmic functions. The first involved taking a simple logarithmic statement, switching it around to the corresponding exponential statement, and then figuring out the  $x$ -value needed for that exponent ( $y$ -value). The second, the T-chart method, is carried out by taking powers of the base of the function as  $x$ -values and finding the corresponding  $y$ -values. The teacher educator identified this method as preferred because it requires learners to know the procedures for finding the values of logarithmic functions. For example, to draw the graph of  $\log_2(x)$ , PSTs first list some values of  $x$  and  $y$  on the T-chart and then sketch the graph by connecting points as indicated in Figure 2. He acknowledged that this method is challenging for comparing multiple graphs on the same axes. For example, it is difficult to exactly identify which graph approach the  $y$  axis when  $x > 1$ , and  $0 < x < 1$ . The remaining results are presented in three sections corresponding to the questions in Figure 1.

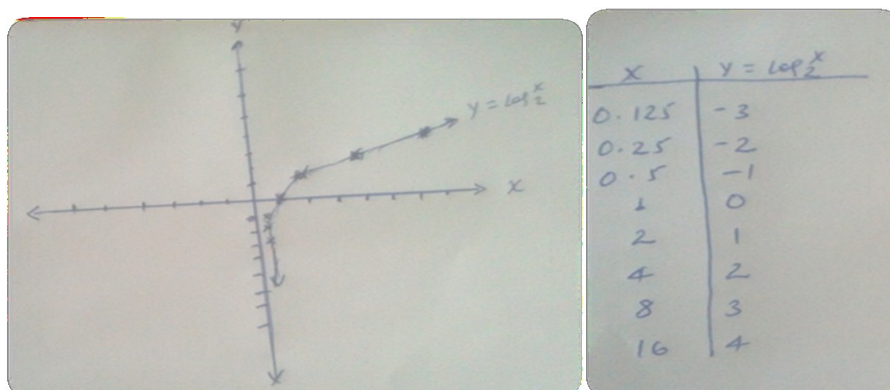

Figure 2: T-chart and graph for  $f(x) = \log_2(x)$

### Graphing logarithmic functions

The teacher educator began by presenting the definition of the logarithmic function,  $y = \log_b(x)$ , where  $b$  is any number such that  $b > 0$ ,  $b \neq 1$  and  $x > 0$ . Using MSM, each group of PSTs was able to draw multiple graphs of logarithmic functions easily, with distinct colours, and on the same axes, as illustrated in Figure 3. They were required to write the equation in the “writing box” and click on the icon ‘graph’ to find the graph of the corresponding equation, and appeared to enjoy sketching the graphs.

During the interview a PST pointed to the effect of using the software on learners' engagement while admitting incomplete understanding of what was happening. She said:

The software helped me to easily sketch each graph on the same  $x$ - $y$  axis with distinct colours; however, I don't know clearly how it happens. (PST 1)

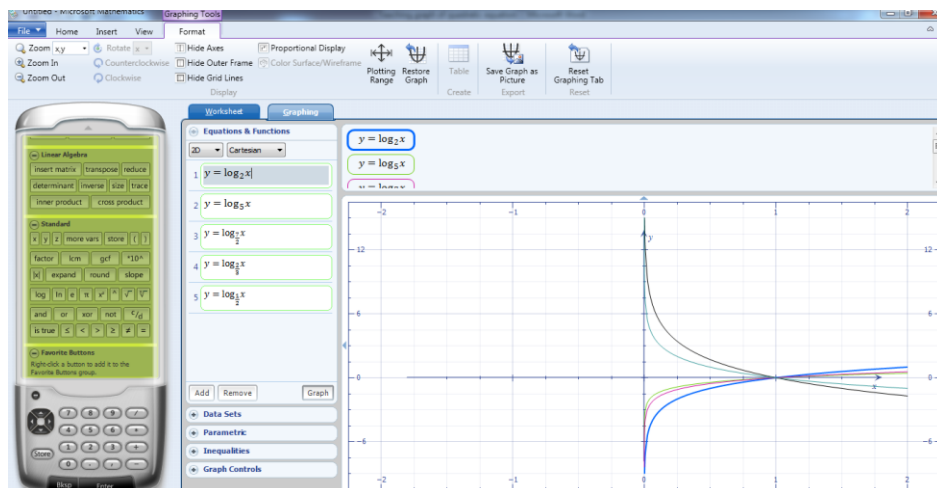

Figure 3: Graphs of some logarithmic functions created in MSM

### Describing shapes of the graphs when $b > 1$ , and $0 < b < 1$

Using MSM, the PSTs were able to describe the shapes of the graphs with a general equation  $f(x) = \log_b(x)$  without sketching multiple graphs but rather by changing the value of  $b$  between  $b > 1$ , and  $0 < b < 1$  using the “Animate” feature of MSM to generate a movie of different graphs as  $b$  changed. Alternatively,  $b$  could be directly controlled by inputting a value. Using the animate icon, PSTs observed and described the shapes of logarithmic functions for values of  $b$  between 0 and 2. In the video-recorded lesson, they appeared to recognise and appreciate the shape change when  $b$  hurdles 1. During the interview, a PST indicated his interest in these animations.

I liked the role of “animate” to clearly see the shape of the graphs of multiple logarithmic functions as the base  $b$  varies without sketching samples of multiple graphs. (PST 3)

PST1 indicated the impression as  $b$  hurdles 1 as:

By using animate function I was able to understand the graph approached positive  $y$  axis as  $b < 1$ , whereas, it approached negative  $y$ -axis as  $b > 1$ . (PST1)

### Describing the common properties of the graphs of logarithmic functions

With MSM the groups of PSTs readily identified that all logarithmic functions have the same general shape, with their graphs varying depending on the base and coefficients in the equation. During the lessons, PSTs were pointing to the graphs made using MSM to identify and describe the common properties (For example, the fact that all have a vertical asymptote at  $x = 0$ , and cross the  $x$ -axis at  $x = 1$ ) of the logarithmic function in each category,  $b > 1$ , and  $0 < b < 1$ . When interviewed a PST described the usefulness of MSM as follows:

I liked the software which helped to graph all logarithmic functions on the same  $x$ - $y$  axis with different colours. This helped me to list and understand the common properties of logarithmic function as the base,  $b$  varies. (PST 2)

### **Describe shapes of the graphs when $x > 1$ , $0 < x < 1$ , $x = 1$**

Most groups of PSTs described the shapes of the graphs by observing the sketched graphs. However, one group was observed trying to identify the properties of the graphs through 'Trace' function of MSM. The trace function varies the values of  $x$  continuously and  $y$  for a given base  $b$ , as  $x$  moves through a specified range of values. In this case PSTs identified the values of  $y$  as  $x$  moved between  $x > 1$ ,  $0 < x < 1$ .

### **Summary of the teacher educator and PSTs' reflections on the lessons**

PSTs expressed a range of perspectives on the use of MSM in learning graphs of logarithmic functions. One of the PSTs had mixed feelings about using MSM, expressing a preference to use both. Although she recognised the significance of technology, she tended to believe that graphs of logarithmic function should be first taught without using any ICT then later by MSM. This was the same PST who had admitted being unsure of how MSM produced the graphs. Another explained the advantage of MSM comparing with his previous lessons. He said:

At the first glance, the graph of the logarithmic function can easily be mistaken for that of the square root function when sketching manually. Both the square root and logarithmic functions have a domain limited to  $x$  values greater than 0. However, the logarithmic function has a vertical asymptote descending towards negative  $\infty$  as  $x$  approaches 0, whereas the square root reaches a minimum  $y$  value of 0. This difference was clearly demonstrated by using MSM. (PST 3)

Another PST indicated that MSM helped to externalise his reasoning, work at his own pace, and manage the complexity of the task scaffolding pen-and-paper skills. He said:

MSM complements my learning of graphs of logarithmic function by helping to visualise, understand, and animate to identify their properties. ... I liked the process as I was engaged and discussed with peers throughout the process and it was a different approach. (PST 2)

The teacher educator described the role of MSM as follows:

The software was vital and complements PSTs' ability to discuss the problem by engaging PSTs in a small group guided by me. The discussion within their small groups was thought provoking as they were engaged through manipulating the computer. I liked MSM as it complements my efforts by helping PSTs to visualise graphs of logarithmic functions as well as provoked active engagement of PSTs.

## **DISCUSSION AND CONCLUSION**

The study illustrated the use of specific software to teach a specific mathematics topic for understanding. MSM provided a variety of utilities that were able to engage PSTs to relearn, and reorganise their knowledge of graphs of logarithmic functions. Although the interviewed PSTs recognised benefits of technology, one of them believed that the topic should be taught with traditional methods before being explored



using technology. Chee et al. (2005) claimed that such a preference can be due to the difficulty teachers have in adopting appropriate pedagogies for particular software. Given the inexperience of teaching with technology of the teacher educator in this study inexpert pedagogy may underpin this PST's opinion as well as her difficulty in understanding exactly what was going on.

PSTs readily used MSM to visualise graphs and identify their properties. The animate facility allowed them to display the graphs as desired based on changing parameters, and helped to facilitate discovery-style lessons (Morrison et al., 2000). These software capabilities were particularly important for the chosen mathematics content because difficulties had been identified in relation to students' ability to distinguish the graphs of different logarithmic functions (Chua & Wood, 2005). In addition, MSM supported the PSTs to describe the graphs of logarithmic functions and appeared to support their understanding of the topic. The usefulness of MSM in learning about the graphs of logarithmic function appeared due to its ability to:

- Facilitate the learning processes through making it easier to produce graphs of logarithmic functions on the same axes accurately,
- Make the lesson more engaging through enabling the tasks based on trial, improvement and experimentation,
- Help PSTs to notice the effects of altering particular parameters (in this case the base of a logarithmic function) on the properties of the function's graph, and
- Foster PSTs' peer exchange through providing support for exploration and consequent sharing of discoveries.

Although focussed on the use of specific software (MSM) to teach a specific mathematical concept (graphs of logarithmic functions), the study suggests that software with similar capabilities (graphing and animation) could be useful for other functions in which visualisation and change in graph characteristics across the function domain are important features. It has also demonstrated the potential of freely available software to help teachers in developing countries and other contexts in which resources are limited.

## References

- Abu-Naja, M. (2008). The effect of graphic calculators on Negev Arab pupils' learning of the concept of families of functions. *Research in Mathematics Education*, 10(2), 183-202.
- Barron, B., & Engle, R. A. (2007). Analyzing data derived from video records. In S. J. Derry (Ed.). *Guidelines for video research: Recommendations from an expert panel* (pp. 25-33). Chicago: Data Research and Development Centre.
- Chee, C., Horani, S., & Daniel, J. (2005). A study on the use of ICT in mathematics teaching. *Malaysian Online Journal of Instructional Technology*, 2(3), 43-51.
- Chua, B., & Wood, E. (2005). Working with logarithms: Students' misconceptions and errors. *The Mathematics Educator*, 8(2), 53-70.

- Creswell, J. W. (2009). *Research design: Qualitative, quantitative, and mixed methods approaches*. Thousand Oaks, CA: Sage Publications.
- Desta, D., Chalchisa, D., Mulat, Y., Berihun, A., & Tesera, A. (2009). Enhancing active learning through self- and peer-reflections: The case of selected schools in Ethiopia. *Journal of International Cooperation in Education*, 12(1), 71-87.
- Goos, M., Galbraith, P., Renshaw, P., & Geiger, V. (2003). Perspectives on technology mediated learning in secondary school mathematics classrooms. *The Journal of Mathematical Behavior*, 22(1), 73-89.
- Hennessy, S., Harrison, D., & Wamakote, L. (2010). Teacher factors influencing classroom use of ICT in sub-Saharan Africa. *Itupale Online Journal of African Studies*, 2, 39-54.
- Hohenwarter, J., Hohenwarter, M., & Lavicza, Z. (2009). Introducing dynamic mathematics software to secondary school teachers: The case of GeoGebra. *Journal of Computers in Mathematics and Science Teaching*, 28(2), 135-146.
- Holmes, K. (2009). Planning to teach with digital tools: Introducing the interactive whiteboard to pre-service secondary mathematics teachers. *Australasian Journal of Educational Technology*, 25(3), 351-365.
- Kennewell, S. (2001). Using affordances and constraints to evaluate the use of information and communications technology in teaching and learning. *Journal of Information Technology for Teacher Education*, 10(1-2), 101-116.
- Kenney, R., & Kastberg, S. (2013). Links in learning logarithms. *Australian Senior Mathematics Journal*, 27(1), 12.
- Koehler, M. J., & Mishra, P. (2005). What happens when teachers design educational technology? The development of technological pedagogical content knowledge. *Journal of Educational Computing Research*, 32(2), 131-152.
- Makgakga, S., & Sepeng, P. (2013). Teaching and learning the mathematical exponential and logarithmic functions: A transformation approach. *Mediterranean Journal of Social Sciences*, 4(13), 177.
- Ministry of Education. (2010). *Education sector development program IV (ESDP IV) 2010/2011 – 2014/2015: Program action plan*. Ethiopia, Addis Ababa. Retrieved from [http://planipolis.iiep.unesco.org/upload/Ethiopia/Ethiopia\\_ESDP\\_IV.pdf](http://planipolis.iiep.unesco.org/upload/Ethiopia/Ethiopia_ESDP_IV.pdf).
- Morrison, J. B., Tversky, B., & Betrancourt, M. (2000). *Animation: Does it facilitate learning?* Paper presented at the AAAI Spring Symposium on Smart Graphics, Stanford, CA.
- Nord, G., & Nord, J. (2011). The Microsoft Word free mathematics add-in and Microsoft Mathematics Beta 4.0. *Proceedings of the 5<sup>th</sup> international multi-conference on society, cybernetics and informatics* (Vol. 1, pp. 139-143). Orlando, FL: IMSCI.
- Pierce, R., & Stacey, K. (2010). Mapping pedagogical opportunities provided by mathematics analysis software. *International Journal of Computers for Mathematical Learning*, 15(1), 1-20. doi: 10.1007/s10758-010-9158-6
- Stigler, J., & Hiebert, J. (1997). Understanding and improving classroom mathematics instruction: An overview of the TIMSS video study. *Phi Delta Kappan*, 79, 14-21.

# REVEALING STUDENTS' CREATIVE MATHEMATICAL ABILITIES THROUGH MODEL-ELICITING ACTIVITIES OF “REAL-LIFE” SITUATIONS

Talya Gilat, Miriam Amit

Ben Gurion University of the Negev, Israel

*The study described herein is part of a larger, inclusive research study exploring the effects of model-eliciting activities (MEAs) of “real-life” situations on the development of students' mathematical creativity. This part aim at revealing students' cognitive abilities that are involved in the creative modeling processes using a qualitative analytical method. The participants were mathematically talented students, members of the “Kidumatica” math club. The data include videotapes, classroom observation and modeling products. Three core categories—appropriateness, ‘mathematical resourcefulness’ and inventiveness—of students' cognitive creative abilities are identified, defined and illustrated. These findings may give a better understanding of the larger concept of mathematical creativity.*

## INTRODUCTION

The knowledge revolution and the impressive technological innovations that characterize today's world require the facilitation and development of “the innovators of tomorrow who can lead the way forward” (National Science Board, 2010, p. 7). In line with this, educators and researchers are still investigating how the educational system can identify, promote and develop students' innovative and creative potential (Sriraman, 2009; National Science Board, 2010; OECD, 2013).

According to the new report of PISA's mathematics framework (OECD, 2013), formulating “real-life” situations mathematically is a fundamental ability that invokes creativity since “outside the mathematics classroom, a challenge or situation that arises is usually not accompanied by a set of rules and prescriptions...Rather it typically requires some creative thought in seeing the possibilities...” (p. 31).

Model-eliciting activities (MEAs) involving “real-life” situations outside the classroom not only provide students with the opportunity to apply their creative skills, but also encourage the development and improvement of those skills (Lesh & Doerr, 2003; Lesh & Caylor, 2007; Amit & Gilat, 2013). This development of creativity goes “hand-in-hand” (National Science Board, 2010, p. 20) with its identification, which predefined the goal of the present study to identify and reveal the cognitive abilities applied and activated by students when modeling creative processes for “real-life” situations.

## CREATIVITY AND MATHEMATICAL MODELING

The following review is organized around the creative process, abilities and production or product (Guilford, 1950, 1967; Sternberg & Lubart, 1999; Sriraman, 2009).

Guilford (1967) described the creative process as a sequence of thoughts and actions resulting in a novel production, and defined creativity as divergent thinking with its four mental abilities: fluency, flexibility, originality, and elaboration. According to Kruteskii (1976), mathematical creativity appears as flexible mathematical thinking which involves “switching from one mental operation to another qualitatively different one” (p. 282), and depends on openness to free thinking and exploration of diverse approaches to a problem. Sriraman (2009) revealed the common characteristics of mathematical creativity through the Gestalt model of the creative process, defining mathematical creativity as the ability to produce a novel or original solution to a non-routine problem. Sternberg and Lubart's (1999) widely accepted definition asserts that creativity is "the ability to produce work that is both novel and appropriate" (p. 3).

Mathematical MEAs provide the student with opportunities to deal with non-routine "real-life" challenges. These activities are designed according to six principles: reality, model construction, self-evaluation, documentation, sharability and reusability, and an effective prototype (Lesh & Caylor, 2007). This thoughtful design not only engages students in multiple cycles of modeling development in which they are given the opportunity to construct powerful and creative mathematical ideas relating to complex and structured data (Lesh & Caylor, 2007; Gilat & Amit, 2012; Amit & Gilat, 2013). It also allows following students' thinking and pattern of reasoning and requires students to represent a general way of thinking instead of a specific solution for a specific context. Therefore, the current study was designed to identify and conceptualize students' cognitive abilities that are involved in, promote and contribute to the development of the creative modeling process and its significant outcomes.

## **METHODOLOGY**

This study made use of deep qualitative analyses based on an intervention program of model-eliciting activities (MEAs) to answer the above-defined questions. This study is part of more inclusive research aimed at developing creativity through MEAs of "real-life" situations. The study was conducted with 71 "high-ability" and mathematically gifted students in 5<sup>th</sup> to 7<sup>th</sup> grades who are members of the "Kidumatica" math club (Amit, 2012), for an entire academic year, applied in weekly 75-minute meetings. The intervention program included four workshops based on different MEAs reflecting “real-life” situations, which were worked on by small groups of 3–4 students. Each MEA workshop had three parts: a warm-up activity, a modeling activity and a poster-presentation session. The modeling task asked students to solve a mathematically complex “real-life” problem for a hypothetical client.

### **Data Sources**

Data were derived from: (1) the students' products, i.e. written documents such as mathematical models, poster presentations, letters to the hypothetical client and drafts, (2) video-recordings of the modeling sessions and of students' oral presentations, interviews (performed while students were working on their models in groups and

during their model presentation), and (3) classroom observation by the researchers and a trained tutor.

### Analytical Methods

Analyses were based on: (1) 'key concepts' (Mostyn, 1985) serving as conceptual ideas for interpreting and coding the data; (2) identification of 'critical events' based on Powell, Francisco, and Maher's (2003) analytical model for analyzing massive videotaped data, and (3) the Way of Thinking Sheets (WTS) (Lesh & Clarke, 2000; Chamberlin, 2004) instrument for organizing and documenting students' massive MEA products.

### Phases of Data Analysis

Data analysis was comprised of an exploratory phase (see Figure 1), and three phases that were repeatedly applied to analyse the data and generate the categories:

1. The exploratory phase (research) provides a better understanding of the phenomenon (Gilat & Amit, 2012) and contributes (most) to the refinement and distillation of current theoretical research frameworks and to the determination of preliminary categories (Hsieh & Shannon, 2005).
2. The data-reduction phase involves inclusive data processing of massive video data collected during the course of the MEAs using Powell et al.'s (2003) analytical model of 'critical-event' identification. These identified critical events were transcribed and mapped for further analysis.
3. The data-organization phase allows for a better understanding of the students' work; each group's modeling products were gathered and documented using WTS (Chamberlin, 2004) and mathematically interpreted as shown in Figure 4 further on.
4. The integrated formal phase mainly concerns final assignment of categories to the data obtained from the previous analytical phases utilizing 'key concept' (Mostyn, 1985) as the coding rule for assigning categories to the data.

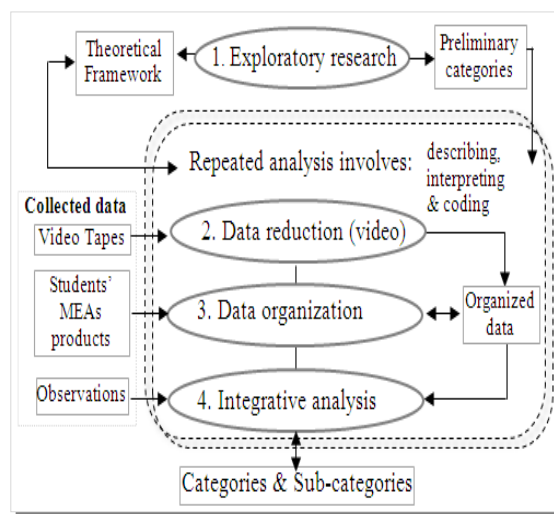

Figure 1: Qualitative analysis flowchart

Throughout the analytical phases (see Figure 1), data are repeatedly described, interpreted and coded for subsequent analysis; each phase strengthens the former phase's interpretations and coding, until a coherent interpretation is obtained. Initial categories were refined and revised until all three main categories and subcategories were generated and defined (based on the theory and the empirical data) and all data were interpreted and coded accordingly. Finally, the categories were ordered

hierarchically (see Figure 2) and the relationships between categories and subcategories were identified and conceptualized (Hsieh & Shannon, 2005).

This multi-method triangulation (data-collection methods, analytical methods and analytical phases) provides a richer understanding by uncovering the deeper meaning of the students' cognitive abilities (Lesh & Caylor, 2007), as well as providing us with better validity of data interpretation, enhancing the rigor of the research (Patton, 2002).

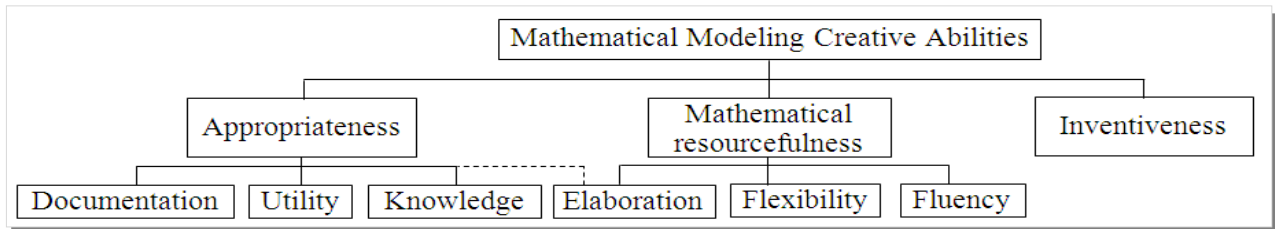

Figure 2: Categorization of students' creative mathematical modeling abilities

### Students' Creative Abilities: Categories and Results

The following provide explicit definitions, examples and coding rules utilizing 'key concepts' as conceptual ideas (see Tables 1–3) for each established category and its subcategories. These categories encapsulate the abilities that contributed to, and constituted the creative modeling process and its significant outcomes.

Examples illustrating the meaning of the categorization are given using research data from one group of 6th-grade students' MEA which was considered as showing the best understanding. This MEA was based on the "Bigfoot" modeling task of a "real-life" situation (Lesh & Doerr, 2003) which required students to develop a conceptual tool that would enable estimating an individual's height. Students received a cardboard with an image of an authentic large footprint's stride (Figure 3) and a measuring tape.

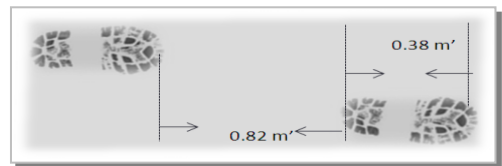

Figure 3: Image of an authentic large footprint's stride

The following is a transcript of the poster presentation given by students A' and S'; Figure 4 shows the students' MEA documentation using WTS (Chamberlin, 2004) and the researcher's (R') mathematical interpretation of their work.

- 1: A': At the beginning we tried measuring only the length of each of our shoes, and then our height, but we couldn't find any operation that led us to our height.
- 2: S': We measured the perimeter of our shoes but none of the operations we used led us to a reasonable height.
- 3: A': Then we measured the width of our shoes.
- 4: S': We tried width plus length multiplied by a whole number, for instance 5; for me it was right but for him [A'] it wasn't. It was more than his height.
- 5: A': Then we noticed that my shoe is relatively wider and S's shoe is narrow in comparison to its length.

- 6: S': So we decided that if the shoe in its narrowest part [pointing to his drawing] is less than 10 cm, we multiply it by 5. Otherwise we multiply by 4.
- 7: A': We tried it [their formula] on Y' [member of another group] too.
- 8: R': I can see that you wrote A/S and erased the explanation you wrote in words.
- 9: S': We didn't have time to complete our solution and find ways to describe the exact ratio so we compared the shoe's width to 10 cm and multiplied it by a fixed number, 4 or 5.
- 10: A': We wanted to use the proportion between length and width and to find a formula but we didn't have enough time for that so we just wrote A/S.

WTS - Ways of Thinking Sheets	
Description of Strategies	Stuents's mathematics and its formal interpretation
<p>Students went through several development phases, at their final phase they utilized both dimensions (shoes' length and width) to calculate the ratio.</p> <p>Strategy: Ratio (depends on different shoe width) multiply by (width+length)</p> <p>Note: Model is easy to implement, partially accurate, some model testing, revision, or feedback incorporated.</p>	<p>Students took measurements of their shoes' length and width and of their height. Students summed shoe length and width and calculated the ratio between this sum and their height';</p> <p>Researcher's interpretation of students development phases</p> <p>First phase:  <math>H = R * X</math></p> <p>Second phase:  <math>H = \begin{cases} R_1 * X &amp; \text{if Shoe's width} &lt; 10 \\ R_2 * X &amp; \text{if Shoe's width} &gt; 10 \end{cases}</math></p> <p>Third phase:  <math>H = X * R \left( f \left( \frac{\text{shoe's length}}{\text{shoe's width}} \right) \right)</math>  <math>X = (\text{shoes' length} + \text{Shoes' width})</math>  <math>H = \text{Height},</math>  <math>R = \frac{H}{X}</math></p>

Figure 4: WTS documenting 6<sup>th</sup>-grade students' "two-dimensional" model

### Appropriateness

Main Category & Subcategories	Coding rule: "MEAs' correct response" (as 'key concept')
	Defined as
Appropriateness	Broader range of mathematical knowledge and abilities to produce a reusable and sharable conceptual tool.
1. Knowledge	Students' ability to utilize their prior and developed mathematical knowledge in various ways to develop an appropriate model.
2. Utility	Deliberate actions or means applied by students to generate useful solutions, not only for the current situation, but for other similar situations as well (reusable).
3. Documentation	Students' ability to apply varied representations to present and share information with others (sharable).

Table 1: Explicit definitions of appropriateness and its subcategories

1. Knowledge: The transcript (lines 1, 2 & 1, 9) demonstrates how students apply their mathematical knowledge to construct (measure, code and synthesize) a relevant mathematical "object" such as their height and their shoe length, and mathematize the relationships between these "objects" to estimate their height (see also researcher's interpretation in the third phase, Figure 4).

2. Utility: In the transcript (lines 6, 7), students explain how they deliberately developed a useful conceptual mathematical tool to estimate the height of students in their group that could also be applicable to other students' data (similar situations).
3. Documentation: The students' poster in Figure 4 shows how students used symbols, "drawing" and written explanations to mathematically communicate "how" they were actively attempting to make sense of the structured problematic "real-life" situation in a way that could be sharable with others.

### Mathematical Resourcefulness

Main Category & Subcategories	Coding rule: "overcome difficulties" (as 'key concept')
	Defined as
<b>Mathematical Resourcefulness</b>	Students' ability to cope in a coherent and fluent manner and demonstrate flexible thinking involving consideration of different approaches or strategies to construct and elaborate a powerful conceptual tool.
1. Fluency	Students' tendency to consider or evaluate several ideas and perspectives.
2. Flexibility	Students' ease in switching from one mental operation to another, applying redefinition and transformation, and finding new ways to describe both the dataset and its behavior.
3. Elaboration	Students' refinement, generalization and integrating abilities applied to developing a new level of more abstract or formal understanding.

Table 2: Explicit definitions of mathematical resourcefulness and its subcategories

1. Fluency: The transcript (lines 1, 2) shows early stages of the students' modeling process which involved fluent generation of different relevant mathematical objects, including shoe width, shoe length, shoe perimeter and student's height, before an effective solution emerged.
2. Flexibility: In the transcript (lines 5–7), students describe how verifying their early conceptualization of the situation required further refinement that takes into account more "discovered" information and more relationships among the data that better describe their advanced interpretation, leading to the development of a more powerful mathematical model (Figure 4). This example reflects students' ease in switching from one mental operation to another to describe both the dataset and its behavior via different types of representations.
3. Elaboration: The conceptual mathematical instrument demonstrated in Figure 4 and the transcribed explanation (lines 8–10) show how students elaborated (extended, refined and integrated) their ideas to develop a new level of more abstract or formal understanding and create a more generalized conceptual tool, as shown in the researcher's mathematical interpretation in Figure 4.

### Inventiveness or Originality

To assign this category to the data, we looked for an appropriate and unique mathematical response in comparison to those developed by other groups (Guilford, 1967).



<b>Main Category</b>	<b>Coding rule:</b> “unique responses” (as key concept)
	<b>Defined as</b>
<b>Inventiveness or Originality</b>	Students’ ability to break away from routine or bounded thinking to create unique and powerful mathematical ideas that differ from those developed by most other students.

Table 3: Explicit definitions of inventiveness

The conceptual tool in Figure 4 illustrates students’ inventiveness. Although there were two other groups (out of 22) that estimated the individual’s height based on the ratio between height and the sum of shoe length and width, only this group used a split function to mathematically describe how an individual’s height depends on the width and length of his or her shoes.

## CLOSING REMARKS

This paper highlights the innovative analytical process and reveals the cognitive abilities that were applied and activated while modeling a creative process by “high-ability” and mathematically gifted students, toward creating and inventing a more significant conceptual tool. Three categories and subcategories were formulated with respect to theoretical framework and empirical data: mathematical appropriateness consisting of three subcategories: knowledge, documentation and utility; mathematical resourcefulness involving fluency, flexibility and elaboration, and inventiveness or originality.

These results have both theoretical and practical implications (Amit, 2012; Amit & Gilat, 2013). In practice, they suggest new directions and alternatives for encouraging and inducing students to draw on those resources and abilities more productively as suggested by Guilford (1950), who argued that creativity can be developed and the “development might be in the nature of actual strengthening of the functions involved or it might mean the better utilization of what resources the individual possesses, or both” (p. 448). Theoretically, viewing students’ MEAs through the notions of the three above core types of abilities can provide us with a deeper insight into what is involved in the creative mathematical process of young students engaging in non-routine, “real-life”, structured problem-solving (Sriraman, 2009).

## References

- Amit, M. (2012). The Kidumatica experience: Cultivating mathematical giftedness and creativity in a multicultural society. *Proceedings of the 12<sup>th</sup> International Congress on Mathematical Education* (pp. 1138-1145). Seoul, Korea: COEX.
- Amit, M., & Gilat, T. (2013). Mathematical modeling through creativity lenses: Creative process and outcomes. In A. M. Lindemeier & A. Heinze (Eds.), *Proc. 37<sup>th</sup> Conf. of the Int. Group for the Psychology of Mathematics Education* (Vol. 2, pp. 9-16). Kiel: PME.
- Chamberlin, M. T. (2004). Design principles for teacher investigations of student work. *Mathematics Teacher Education and Development*, 6, 61-72.

- Gilat, T., & Amit, M. (2012). Teaching for creativity: The interplay between mathematical modeling and mathematical creativity. In T.-Y. Tso (Ed.), *Proc. 36<sup>th</sup> Conf. of the Int. Group for the Psychology of Mathematics Education* (Vol. 2, pp. 267-274). Taipei, Taiwan: PME.
- Guilford, J. (1950). Creativity. *American Psychologist*, 19(5), 444-454.
- Guilford, J. P. (1967). *The nature of human intelligence*. New York: McGraw-Hill.
- Hsieh, H. F., & Shannon, S. E. (2005). Three approaches to qualitative content analysis. *Qualitative Health Research*, 15, 1277-1290.
- Kruteskii, V. (1976). *The psychology of mathematical abilities in schoolchildren*. Chicago: University of Chicago Press.
- Lesh, R., & Caylor, B. (2007). Introduction to the special issue: Modeling as application versus modeling as a way to create mathematics. *International Journal of Computers for Mathematical Learning*, 12, 173-194.
- Lesh, R., & Clarke, D. (2000). Formulating operational definitions of desired outcomes of instruction in mathematics and science education. In A. Kelly & R. Lesh (Eds.), *Handbook of research design in mathematics and science education* (pp. 113-150). Mahwah, NJ: Lawrence Erlbaum.
- Lesh, R., & Doerr, H. (2003). Foundation of a models and modeling perspective on mathematics teaching and learning. In R. A. Lesh & H. Doerr (Eds.), *Beyond constructivism: A models and modeling perspective on mathematics teaching, learning, and problem solving* (pp. 9-34). Mahwah, NJ: Erlbaum.
- Mostyn, B. (1985). The content analysis of qualitative research data: A dynamic approach. In M. Brenner, J. Brown, & D. Canter (Eds.), *The research interview* (pp. 115-145). London, UK: Academic Press.
- National Science Board. (2010). *Preparing the next generation of STEM Innovators: Identifying and developing our national's human capital*. Arlington, VA: National Science Foundation. Retrieved from <http://www.nsf.gov/nsb/publications/2010/nsb1033.pdf>
- OECD. (2013). Mathematics framework. In *PISA 2012 assessment and analytical framework: Mathematics, reading, science, problem solving and financial literacy*. Paris: OECD Publishing. Retrieved from <http://dx.doi.org/10.1787/9789264190511-3-en>
- Patton, M. Q. (2002). *Qualitative research and evaluation methods* (3<sup>rd</sup> ed.). Thousand Oaks, CA: Sage.
- Powell, A. B., Francisco, J. M., & Maher, C. A. (2003). An analytical model for studying the development of mathematical ideas and reasoning using videotape data. *Journal of Mathematical Behavior*, 22(4), 405-435.
- Sriraman, B. (2009). The characteristics of mathematical creativity. *ZDM-The International Journal on Mathematics Education*, 41(1&2), 13-27.
- Sternberg, R. J., & Lubart, T. (1999). The concept of creativity: Prospects and paradigms. In R. Sternberg (Ed.), *Handbook of creativity* (pp. 251-272). Cambridge: Cambridge University Press.

# VALIDATING IN THE MATHEMATICS CLASSROOM

Manuel Goizueta<sup>1</sup>, Maria Alessandra Mariotti<sup>2</sup>, Núria Planas<sup>1</sup>

<sup>1</sup>Universitat Autònoma de Barcelona, <sup>2</sup>Università degli Studi di Siena

*The focus of this report is on the process of resolution of a task; specifically, on the validation of the mathematical model proposed by a group of students and the numerical result that is constructed within this model. Habermas' construct of rational behavior is used to describe validity conditions that emerge and are used by the students as means for validation. We take a classroom episode from a design experiment to examine how the emergence of these conditions points to a socially constituted mathematical epistemology in the secondary school mathematics classroom, to shared and tacit principles of the didactic contract concerning the knowledge there, and to non-mathematical references that are taken for granted.*

## CONTEXT AND RESEARCH QUESTION

According to Habermas (2003), accepting a validity claim is tantamount to accepting that its legitimacy may be adequately justified, that is, that the conditions for validity may be fulfilled. Following Boero, Douek, Morselli and Pedemonte (2010), we are interested in characterizing how, in terms of Habermas' rational behavior construct, mathematical activity is supported through the situated emergence and fulfillment of validity conditions. Specifically, in the context of the secondary mathematics classroom, we want to investigate what situated validity conditions (acceptance/rejection) can be observed concerning the resolution process of a task. The current research, as well as previous studies by our team (e.g. Goizueta & Planas, 2013), is in line with the commitment to conceptualizing mathematical argumentation and learning in whole and small group discussions in the mathematics classroom.

We begin by showing how we complement Habermas' construct to better suit the complexity and specificity of the mathematics classroom. This perspective frames our understanding of classroom practices and our approach to data analysis through the integration of social and epistemological issues. We then present and analyze a classroom episode to discuss the emergence of validity conditions throughout the construction of a mathematical model in a problem-solving environment. From here, we briefly discuss the classroom mathematics culture that is being propagated.

## AN INTEGRATED PERSPECTIVE

For the interpretation of what counts as validity conditions and how and why they emerge, we draw on epistemological and social issues. According to Habermas' construct of rational behavior and its adaptation by Boero et al. (2010), in the students' argumentative practices we can distinguish an epistemic dimension (inherent in the epistemologically constrained construction and control of propositions, justifications

and validations), a teleological dimension (inherent in the strategic decision-making processes embedded in the goal-oriented classroom environment) and a communicative dimension (inherent in the selection of suitable registers and semiotic means to communicate within the given mathematical culture).

Steinbring (2005) suggests that a “specific social epistemology of mathematical knowledge is constituted in classroom interaction” (p. 35) along with a criterion of mathematical correctness. The socially constituted mathematics classroom epistemology and the mathematical activity are reciprocally dependent: the former shapes a frame in which the latter takes place and the latter develops the former to conform to the emergence of new legitimated mathematical discourses. In the context of a content-particular task, this relationship between classroom epistemology and mathematical activity must be considered in light of a specific, content-related, didactic contract (Brousseau, 1997). Furthermore, when considering students’ interaction we also consider the references (statements, axioms, visual and experimental evidence, physical constraints, etc.) that may be associated with their argumentative activity. Some references are related to institutionalized corpora (e.g. school mathematical knowledge), but not all of them are. Douek (2007) introduces the notion of reference corpus, which is assumed to be unquestionable and shared; it is operatively used by the students to make sense of the task, semantically grounds their mathematical activity and backs their arguments. Thus, in a task-specific context, validity conditions are explicit or tacit constraints that allow students to control the coherence of the mathematical activity according to the socially constituted classroom epistemology, the reference corpus and the goals.

In what follows, we present the analysis of an episode to illustrate different emerging validity conditions behind the observed practices that students in the classroom enact to validate their arguments. We also account for possible explanations.

## **PARTICIPANTS, TASK AND DATA COLLECTION**

The participants in our design experiment were thirty 14/15-year-old students and their teacher in two lessons in a regular classroom in Barcelona, Catalonia-Spain. It was a problem-solving session, with time for small group work and whole-class discussion. The following task for the two lessons was suggested by the researchers:

Two players are flipping a coin in such a way that the first one wins a point with every head and the other wins a point with every tail. Each is betting €3 and they agree that the first to reach 8 points gets the €6. Unexpectedly, they are asked to interrupt the game when one of them has 7 points and the other 5. How should they split the bet? Justify your answer.

As we ascertained in a pilot experiment, this task can be approached and solved using arithmetical tools, without having been taught formal probability contents, which was the case of this group, although intuitive probabilistic thinking is fundamental to provide a mathematically sound answer. The novelty of the task was expected to lead students to develop models and negotiate meanings, while producing arguments to validate them and avoiding mechanical approaches based on well-established

heuristics. For data collection, two small groups were videotaped and written protocols were collected. For each of the videotaped groups, students were collectively interviewed a week after the task; this set of data is not discussed here.

## DATA ANALYSIS AND RESULTS

The excerpt below illustrates the attempts to cope with the task by the group made up of Anna, Josy, Vasi and Zoe. We point to the students' rational efforts to support the validity of their resolution process; we then account for different types of validity conditions and associate their emergence to different dimensions of the students' rational behavior.

### Genesis of the initial validity conditions

112 Anna This one only needs to get one point and this one three to get to six euros. But obviously, because it's random, the game, you know, one's got more chances because imagine that now, suddenly, if the game didn't stop, you could get three tails in a row and then this one would win. So A does have more chances of winning but B could win as well (...) From what we've got so far, player A would have to get more money... because he's got more points.

Anna interprets the need to split the money in relation to the advantage one player has over the other. By describing the situation as a random game and bringing chance to the fore, she tacitly proposes a frame with which to interpret the task, and within it, she draws on prior experiences with coin-flipping situations, shared notions about the characteristics and dynamics of the game and adequate words to talk about it. This cluster of references empirically and semantically grounds Anna's interpretation of the task and her reference corpus. The meanings that students may associate with this reference corpus act as constraints that any possible answer should meet; it gives the students an operational way to decide not only on the validity of any proposed answer but also on the validity of any mathematical model within which the answer is elaborated. Anna states what can be taken as a necessary validity condition for any possible answer: "player A would have to get more money... because he's got more points." Similarly, "B could win as well" might mean "B should get some part of the bet". This could be considered a validity condition for any forthcoming answer, but since she does not make it explicit, we cannot know the actual status of this statement at this point.

We observe the emergence of a first validity condition that any model of the situation should satisfy: player A gets more money than player B and, possibly, player B gets more than zero. In terms of Habermas' construct, it is the epistemic dimension of Anna's rational behavior that leads her to establish constraints that match her interpretation of the goal-oriented task according a specific reference corpus. This validity condition is epistemological in nature. Anna's rational activity supports two parallel processes: the abductive search for a plausible model to describe the situation and find a solution to the task, and the justification of its situated legitimacy.

**First model: “one point, how much money”**

- 116 Anna So then, if six is the total...
- 117 Vasi We've got to calculate, if we calculate how much a point is worth.
- 118 Anna Wait, wait.
- 119 Zoe What if we work out the percentage?
- 120 Anna We've got to say one point, how much money.
- 121 Vasi That's what I've just said!
- 123 Zoe One of the eight...
- 124 Anna Yeah, one of the eight, how much is it worth. You know? Six over eight?  
No, sorry. Yeah, six over eight?
- 125 Josy Zero point seven five.
- 137 Zoe ... So, one point is zero point seven five.

When Vasi reminds the group of the need to resort to calculation, we recognize a constraint imposed by the didactic contract: any possible correct answer must be mathematics-related. Behind her suggestion of calculating “how much a point is worth” –marked by the use of ‘have to’– and behind Zoe’s suggestion of working out the percentage, we observe how the teleological dimension of the students’ rationality guides their efforts to seek a suitable mathematical model, according to normative and goal-oriented constraints. The utterance “one of the eight ... one point is zero point seven five” condenses the first model to describe and solve the situation. We may paraphrase it as, ‘if by winning 8 points a player gets €6, for each point won a player should get €0.75’. We relate the emergence of this model to typical school problems about proportional costs, which tend to be solved by manipulating the numerical data appearing in the wording. The use of ‘to be worth’ and the proposed calculation support this interpretation. It is plausible that the focus of the students’ speaking turns is on proportionality as an adequate mathematical content with which to engage in the task. Thus, the clause of the didactic contract stating that any possible correct answer must be mathematics-related acts as a necessary validity condition and forces the students to discard answers that might be somehow considered non-mathematical and seek mathematics-related ones. Of the rational efforts to solve the task, we can distinguish two different validity conditions: a first epistemic one about the need to account for the reference corpus-based interpretation of the task, and a second normative one about the need to conform to a basic premise of the didactic contract. Under these constraints, we observe the abductive emergence of a first proportional model providing an intermediate result: each player gets €0.75 for each point won.

**Model falsification and new validity conditions**

- 139 Josy No, but then, they only get to six euros if they win eight points and here they've won twelve points.
- 140 Anna That's true.

Josy checks the result obtained and realizes that accepting the proposed model necessarily leads to an incoherent interpretation of the situation, and in so doing, she is falsifying the proposed model. Her reasoning may be related to a well-established principle of the didactic contract about applying proportionality to this kind of problem: a correct result is confirmed by performing ‘the opposite operation’. The rejection of a contradictory model accounts for the epistemic dimension of Josy’s rational behavior. This falsifier will play a crucial role in deciding about the validity of the model by acting as a new necessary epistemic validity condition: any valid model must be immune to this falsifier. Due to the relation between falsifier and resolution, we call it heuristic. By acting as a validity constraint, this heuristic is at the root of the emergence of a second proportional model and its assessment.

### Second model: “we’ve got to divide by twelve”

- 142 Anna      Then we’ve got to divide the seven, hold on, we’ve got to divide, seven plus five, twelve. So we’ve got to divide by twelve. How much is it divided by twelve? (...) Zero point five. So zero point five times seven? Calculate that a second.
- 149 Josy      Three point five.
- 151 Anna      And zero point five times five?
- 152 Zoe      Two point five.
- 153 Anna      And two point five plus three point five?
- 154 Josy      Exactly.
- 155 Anna      That’s it!

In order to overcome Josy’s falsification, Anna proposes a new model that corresponds to a distribution that is proportional to the points won by each player. Driven by the need for epistemic coherence, the students in the group assess this new model using an equivalent version of the heuristic falsifier developed (assuming that 12 points were won): the amounts of money that the players receive must add up to six. By producing a numeric solution for the task (€3.50 for player A and €2.50 for player B) the students prove the model’s immunity to the heuristic falsifier and, on that basis, seem to validate the new model and the numerical result. The focus of the students’ activity shifts therefore to showing that the new model cannot be falsified in the same way the previous model was, which for them appears to be a positive confirmation of adequacy.

### Explaining the solution to the teacher

- 190 Anna      We thought that... well, player A has got seven points and B five points. We thought that if they won four points each, three euros for each one, and the distribution would be fair. Then we did six euros divided by eight, which is the total... by how many points... I mean, how much one point would be, eight points in total. You know? But then we said no, no, no. Because they got twelve points in total... and then we multiplied each point they won by the 0.5 that one point costs and we got it exactly [on the sheet, “player A: €3.50 and player B: €2.50, “ $2.5 + 3.5 = 6$ ”].

Regarding the teleological dimension, we assume that Anna's intention is to convince the teacher about the validity of the answer and the model they constructed. Thus, her explicit discourse highlights what she considers relevant reasons for that purpose. She starts by introducing the situation of a tied game that can be considered a generic example, proposes a numerical solution and qualifies it as 'fair'. Anna introduces fairness as a taken-as-shared notion and as the criterion to describe the answer and determine its validity. She then accounts for the first model by focusing on the eight points (needed to win); then discards this model stating, as a reason, that the total points that must be considered is twelve (won points). The explicit, though unclear, mention of the falsifier suggests the relevance that the falsification process had for the students; however, it is difficult to grasp the epistemic roots of such falsifier and its role in the emergence of the second model.

Drawing on her written protocol, Anna then presents the second model, focusing on the role of 0.5 (money per point won) as the intermediate result they used in the group to get the answer. Anna makes their interpretation of the task evident (to split the money according to the points won) and tacitly proposes proportionality as a relevant and adequate mathematical model to solve it. Finally, she says "we got it exactly" while showing in her protocol that 3.5 and 2.5 add up to the original six euros that had to be split. This assessment of the result is significant in the light of the whole solution process, especially if we consider the role played by the heuristic falsifier in discarding the first model and supporting the emergence of the second one. The epistemic status of the result (necessary, plausible, possible...) is not made explicit, but the expression "we got it exactly" constitutes a positive assessment of both the model and the result's validity. This expression takes over the role that 'fair' played in the prior turn: while 'being fair' was the key feature of the proposed distribution that led its validity to be accepted, now 'getting it exactly' is a validation of the answer and becomes the guarantee of 'being immune to the heuristic falsifier.' Anna does not mention the developed validity conditions or their emergence as a rational process in the model's validation. Instead, what appears is the solving process' fit with the didactic contract. The discourse on the validity of the proportional model is evoked during the description of the process, but its recognition is left to the teacher's discernment.

## **CONCLUDING DISCUSSION**

Using Habermas' construct of rational behavior, we have described students' mathematical activity as a twofold rational process: the abductive search for a model to describe the problem situation and solve the task, and the justification of its validity. Initially, the epistemic dimension of the students' rational activity is related to the semantic and empirical grounding of the task according to a reference corpus, leading them to develop an interpretation of the task and the initial necessary epistemic validity conditions. According to the teleological dimension, this suggests that establishing epistemic constraints is a relevant activity to support the construction of a suitable model and that this is done, in part, by creating specific epistemic validity conditions. Later, according to the teleological and communicational dimensions, the didactic



contract-related need to provide a mathematics-related answer, acting as a necessary normative validity condition, is what drives the students' efforts towards the construction of a first mathematical model. It is on the epistemic side that the first model is falsified: its inadequacy to account for the available data leads to its falsification and rejection. A second model is then proposed to overcome what we have considered a heuristic falsifier. For the students, the immunity to the falsifier becomes not just a necessary epistemic validity condition but also a confirmation of the model's validity. However, despite the fact that they are key features in the process, the reference corpus-related epistemic constraints developed as well as the epistemic roots of the falsification are almost absent from the explanation to the teacher, which is instead centered on the link between the numerical solution and what is considered a suitable mathematical model. This indicates the relevance that the didactic contract has for the students when selecting what parts of their production to communicate.

Although limited to the analysis of brief excerpts, we have shown how Habermas' construct of rational behavior helps to investigate and account for the emergence of validity conditions as means to support the validity of mathematical activity. We argue that this is a relevant theoretical instrument to investigate the students' situated practices of validation while keeping track of the complex relationship between the epistemic and social dimensions of the mathematics classroom.

### Acknowledgements

This report is part of the research funded by Project EDU2012-31464, Ministry of Science and Competitiveness, Spain. The collaboration with the second author has been possible due to Grant PIF-UAB-2013 by Universitat Autònoma de Barcelona.

### References

- Boero, P., Douek, N., Morselli F., & Pedemonte, B. (2010). Argumentation and proof: A contribution to theoretical perspectives and their classroom implementation. In M. F. Pinto & T. F. Kawasaki (Eds.), *Proc. 34<sup>th</sup> Conf. of the Int. Group for the Psychology of Mathematics Education* (Vol. 1, pp. 179-209). Belo Horizonte, Brazil: PME.
- Brousseau G. (1997). *Theory of didactical situations in mathematics*. Dordrecht, The Netherlands: Kluwer Academic Publishers.
- Douek, N. (2007). Some remarks about argumentation and proof. In P. Boero (Ed.), *Theorems in school: From history, epistemology and cognition to classroom practice* (pp. 163-181). Rotterdam, The Netherlands: Sense Publishers.
- Goizueta, M., & Planas, N. (2013). Temas emergentes del análisis de interpretaciones del profesorado sobre la argumentación en clase de matemáticas [Emerging themes from the analysis of the teachers' interpretations of argumentation in the mathematics classroom]. *Enseñanza de las Ciencias*, 31(1), 61-78.
- Habermas, J. (2003). *Truth and justification*. Cambridge, MA: MIT Press.
- Steinbring, H. (2005). *The construction of new mathematical knowledge in classroom interaction: An epistemological perspective*. New York: Springer.



# **“I ALSO WANT THEM TO FEEL COMFORTABLE”: AFFECT AND THE FORMATION OF PROFESSIONAL IDENTITY**

Carlos Nicolas Gomez, AnnaMarie Conner

University of Georgia

*Understanding the formation of the professional identities of prospective teachers is important to better understand the decision-making processes of future teachers. Through an exploration of four prospective teachers' visions of practice and designated identities, we found that their images of future students' affective responses while learning mathematics were a strong influence in the prospective teachers' evolving professional identities.*

## **BACKGROUND**

A teacher's professional identity is the framework he or she uses to make sense of and understand problems that arise in practice (Peressini, Borko, Romagnano, Knuth, & Willis, 2004). A prospective teacher's professional identity (a conceptualization of self-as-teacher) evolves during his or her teacher education. "Preparation programs deliberately and inadvertently reinforce the development of different kinds of teaching identities as they emphasize various aspects of what it means to be a teacher" (Hammerness, Darling-Hammond, & Bransford, 2005, p. 382). These evolving conceptualizations directly influence what prospective teachers learn in their educational experiences (Peressini et al., 2004). Furthermore, this process is fraught with emotion (Brown, 2008), and internal tensions surface as the individual begins transitioning from student to teacher (Pillen, Den Brok, & Beijaard, 2013). Nevertheless, little research focusing on the formation of beginning prospective teachers' professional identities has occurred (Friesen & Besley, 2013).

Professional identity has been considered through various lenses and has been operationalized and defined in many ways (Beijaard, Meijer, & Verloop, 2004). Sugrue (1997) defined professional identity as a discourse that is continuously being rewritten by the individual. These discourses are influenced by the individual's background, including immediate family and one's own lay theories of identity formation. Others have focused on a more narrative or storied aspect to professional identity (Lutovac & Kaasila, 2011) by honing in on the manner in which prospective teachers discuss themselves as the protagonists of their stories. On the other hand, some have concentrated on developing activities and tasks for teacher educators to have students reflect on their own formation of self-as-teacher and recognize their future selves as gatekeepers (de Freitas, 2004). Regardless, researchers have proposed that identity formation involves complex multifaceted structures that are perpetually being built, deconstructed, and reconstructed (Flores & Day, 2006).

A deeper understanding of prospective teachers' formation of professional identity is needed to prevent internal tensions (Pillen et al., 2013) and to develop ways to aid preservice teachers in seeing the interconnectedness between their past and future contexts (Flores & Day, 2006). This study focused on the identity formation of four prospective secondary mathematics teachers during their first year in their teacher education program. Our guiding questions were: (a) What characterizes participants' professional identities during their mathematics education coursework and (b) what are participants' goals and values?

## FRAMEWORK

The prospective teachers in this study desired to join a community of educators and to be seen as teachers by others. Because the prospective teachers are situated within multiple communities, a situative perspective on the formation of identity was used throughout this research. From this perspective, professional identity, or the conceptualization of self-as-teacher, is constructed of both cognitive aspects and sociocultural aspects (Peressini et al., 2004). The cognitive aspect of one's professional identity is a "complex constellation of goals, values, commitments, knowledge, beliefs, and other personal characteristics, drawn together to create a sense of 'who I am' as a teacher" (Peressini et al., 2004, p. 79). An important cognitive component not mentioned specifically by Peressini and colleagues is affect. It has been argued that the affective domain, specifically the emotions of the individual, is an important catalyst in the formation of professional identity (Brown, 2008). Affect is the constellation of emotions, attitudes, and beliefs that is connected to an object or event (McLeod, 1992). Hannula (2002) argues that emotions and cognition are, "two sides of the same coin" (p. 27) and splitting the two is done purely for analytic purposes. Two other constructs allowed us to do this: Sfard and Prusak's (2005) construct of designated identity and Hammerness' (2001) concept of vision. Both of these constructs are built on the desires of the individual.

To Sfard and Prusak (2005), identity formation is a part of one's communicative practices, and this discourse aids one in making sense of his or her world; allowing one to plan for the future. These narrations that express a desirable and expected future self are called *designated identities* (Sfard & Prusak, 2005). Accordingly, "they can be recognized by their use of the future tense or of words that express wish, commitment, obligation, or necessity, such as *should, ought, have to, must, want, can, cannot*, and so forth" (Sfard & Prusak, 2005, p. 18). To better understand prospective teachers' formation of professional identities at the beginning of their preparation program, a focus on the way they expressed their designated identities was central to our investigation. Hammerness' (2001) concept of teacher vision helped in looking deeper into the prospective teachers' desires in their narratives of future-self. Vision consists of the "images of what teachers hope *could be* or *might be* in their classrooms, their schools, their community and, in some cases, even society" (Hammerness, 2001, p. 145, emphasis in original). Hammerness' perspective on vision is different than that of professional vision introduced by Goodwin (1994), which focused on how

professionals interpret their current context. Vision is not only how one sees him or herself in the future, but also focuses on the larger social structures to which he or she wishes to belong. What type of school do they wish to work at? What connections do they see between their classroom and the larger community the school exists within? These desires are outside the scope of designated identity. To attain a deeper understanding of one's professional identity, we found it necessary not only to explore who he or she wants to be in the future but also where he or she wants to be in future. Overall, designated identity and vision helped us focus on the ideals that are guiding the participants in their program.

Peressini et al. (2004) also described professional identity to involve a sociocultural aspect, which involves, "the ways in which teachers participate in the activities of their professional communities and present themselves to others in the context of professional relationships" (p. 79-80). We found the use of positioning theory to be useful to explore the sociocultural aspect. We see the prospective teachers to be in the process of finding their place within the community of educators. This means that within their narratives they are also discussing their inclusion within a community of which they desire to be a part. Freeman (2010) claims that how people position themselves reveals how they see themselves, and their understanding of self and others in the community. Exploring how prospective teachers position themselves within the communities of practice that they are attempting to enter helps us in understanding the events that influence their vision and designated identity.

## **METHODOLOGY**

This report is a part of a larger study in which we followed sixteen prospective secondary teachers through their mathematics education program. For this study, we purposefully selected four participants, two males and two females. Alex and Melissa were selected for their descriptive narratives and a deeply reflective account shared at the end of the third interview. Two other participants, Jason and Jill, were selected because a previous preliminary analysis of their beliefs showed that they seemed to differ from Alex and Melissa in their stance about teaching.

Data collection for this study included three video-recorded semi-structured interviews (between 45 and 90 minutes) throughout their first year in the program. The first interview occurred within the first two weeks of entering the program, the second at the end of the first semester, and the third at the end of their second semester. Each interview was transcribed by a member of the research team and checked by another member to verify accuracy. Additionally, observation notes were taken during the participants' field experiences. During the first semester, the participants were enrolled in a course that focused on student thinking and, as part of an associated field experience, worked for nine weeks, once each week, one-on-one with high school students in remedial, on-track, and advanced classes. During the second semester, participants were enrolled in a course that focused on equity and assessment;

participants' field component was focused on small groups in a middle school setting for eight weeks. All artefacts the participants produced were collected.

The interviews were the main source of analysis. Using a constant comparative approach (Glaser & Strauss, 1967), we began by coding participants' narratives for cognitive aspects and sociocultural aspects by following the framework above. Concepts were found for each aspect followed by categorization of emerging themes. Observation notes and artefacts were used as supplementary sources of data for confirming or disconfirming evidence.

## RESULTS

During the second and third interviews, we asked whether the participants felt like teachers during their field experiences, which were set up to enculturate them into the practices of being a teacher. Our participants claimed not to feel like teachers during most of their field experiences, but they felt like teachers if the students positioned them as such. Jill's statement is representative: "Some of the students I feel like kind of not push me away, but like kind of like brush me off, sort of. Like they were just, they kind of, like, had the attitude, 'well you're not the teacher'" (Jill, Int. 3). Experiences like this led Melissa and Alex to see ability to discipline students as a way to be viewed more as a teacher. However, they were confused and conflicted as to where this authority to discipline should come from. Consequently, they both sought out their methods professor (their figure of authority) to position them as disciplinarians, although there is no evidence that they acted upon this new position. On the other hand, Jill and Jason did not seek out ways to discipline but instead focused more on how the students reacted to their aid. Jason thought of preparation as key:

So, when I'm prepared, when we have this assignment ahead of time, we're able to see it and know what the solutions are, different approaches to the solutions. I think students can see that we're prepared, and they treat us more as teachers. (Jason, Int. 3)

Jill focused more on how she perceived if students were successful in learning:

I really did feel like the teacher, because I was sitting there helping them get to the answer and when they finally got it, they were like 'Oh!' and I was like 'huh, I actually helped' you know. So in those ways, yeah, I did feel like a teacher. (Jill, Int. 3)

The ways that students positioned them were more important to the prospective teachers' professional identities than what other authority figures (such as the methods instructor and classroom teacher) claimed; the participants accepted the students' positioning in interpreting whether or not they were or felt like teachers.

One of the more surprising themes arising from our data was the extent to which participants were attuned to their future students' affect while doing mathematics in describing their future actions and values as teachers. Many of the prospective teachers' intended actions were motivated by their perceptions of how students might react or feel. Jason, Jill, Melissa, and Alex discussed desired feelings that students should have when working on mathematics (or when participating in a mathematics

class). This was a major theme that was prominent in every interview. However, each one described these affective responses differently. Even though each one focused on different affective reactions, they talked more about students' affect than they did about other possible motivating factors when describing rationale for their actions.

All four of the participants believe that students need to feel comfortable in their classrooms. This feeling of comfort was a main theme of their interviews, but it was interpreted differently by each of the prospective teachers, and consequently it provoked different intentions with respect to teacher actions. The participants' initial concepts of what it means to be a good teacher were almost exclusively dependent on their views of students' affect when doing mathematics, as perhaps should not be surprising given that their experiences in classrooms up to this point were almost exclusively as students. However, as the participants' professional identities evolved, and they incorporated ideas from their field experiences and pedagogy courses into their visions of themselves as teachers, the theme of concern for how students feel while doing mathematics remained strong. Even though in course assignments and discussions the prospective teachers spoke fluently about appropriate teaching behaviours and rationales for these behaviours, when asked about good teaching or themselves as teachers in the interviews, the participants invariably referred to student affect as the rationale for what they intended to do as teachers.

Melissa desired her students to feel welcome, to feel free to say anything in her classroom. She wanted them to feel like math is applicable so that they would be interested in learning math. But most of all she wanted students to feel challenged but not frustrated. Correspondingly, she wanted to push students, but also to balance challenging students with making sure every student understands the mathematics. Her key description of a good teacher was one who was encouraging and was there for her students. She did not want students to feel frustrated by the mathematics in her classroom. Thus, she felt that she needed to anticipate student responses:

Like you've already planned out what they're going to say. ... You're going to have an answer ready. And I think that for a lot of students that is so helpful because um I just feel like students get frustrated if they ask questions, you're just like I don't know we'll get back to that. The student wants to know right then... It's just like if you can, try to prepare that for your student to make them feel at ease. (Melissa, Int. 2)

Anticipating student responses was discussed in the methods course, although it was not motivated by a discussion of students' frustrations – it was motivated by a desire for the teacher to be prepared to ask appropriate questions to push the students' thinking about the mathematical ideas that were the goal of instruction.

Alex believes students have to feel comfortable in order to learn. Thus a teacher needs to be approachable and encouraging. Students should also feel respected and valued; they should not feel stupid. Thus a teacher should not be intimidating but should strive to be an influence and a role model and should value students as people. Alex described a good teacher as very understanding and very patient. Alex's main concern was to prevent students from feeling, as he did, that they were just "products of the

system” (Alex, Int. 1). He described his own learning of mathematics as surface-level, simply memorizing what was necessary for the test and then forgetting it, and he consequently desired that his students learn to do the mathematics for themselves, valuing group worthy tasks and having students do the mathematics themselves. Like Melissa, Alex’s desire that students not feel like products of the system but feel valued as people became a motivating factor for his desire to implement activities discussed in the pedagogy courses as good teaching: implementing tasks in groups that are worthy of students working in groups and having them do mathematics rather than memorizing rules and procedures.

Jason’s main goal was that students begin to enjoy the mathematics as he himself does. He wants to help his students be interested in the material, and he wants to develop in them an appreciation of the struggle necessary to understand mathematical ideas, or at least a willingness to struggle, work hard, and persevere in their mathematical endeavours. In order to do this, he believes a teacher must be both focused and relaxed, show students that he enjoys being there, and be nice to students. Jason’s goals for student affect are more grounded in mathematics (he tended to view himself more as a mathematician), but the characteristics of a teacher and the teaching actions he described focus on the non-mathematical aspects of teaching: being nice, focused, relaxed, etc. He wants students to be excited about mathematics in general, not necessarily the particular ideas they are supposed to learn that day. Thus, he intends to bring in applications and current events, and to focus students on the logic of math, which he finds to be both essential to learning math and a motivating factor in learning it. “I just want to be the kind of teacher that covers the material but also realizes the students can be excited about math, not just the material, not just the standard” (Jason, Int. 3).

Jill believes that students should feel comfortable in class, both comfortable in asking questions and feeling like the teacher is knowledgeable, trustworthy, and understanding or approachable. This desire for students to feel comfortable seems to stem from the way she believes she learns, “I’m a big believer in getting yourself really confused and then working your way out of it” (Jill, Int. 1). Jill’s descriptions of a good teacher as approachable, flexible, supportive, and encouraging correspond to her desire for students to be able to be confused and work their way out of that confusion in a supportive environment. She desires to emulate a teacher who taught her to work through ideas and to work her way through and out of a tough spot rather than be a “boring” teacher who lectures the whole day (Jill, Int. 1). Jill’s desires to use group work and to focus on student engagement are motivated more by a desire for her students not to be bored than by an acknowledgement that students learn more mathematics when they are engaged in doing mathematics in particular ways.

## **DISCUSSION/IMPLICATIONS**

Students’ affect while doing mathematics was a strong influential factor in how the participants wished to see themselves as teachers, or in other words, in the cognitive



aspect of their professional identity. In particular, the participants' recollections of affective reactions to experiences as students, as observers, or working with students in any setting seemed to have translated into beliefs about how they want students to feel and what teachers should do (or not do) in order for students to have those feelings. Britzman (2009) describes this paradox prospective teachers face:

Newcomers learning to teach enter teacher education looking backward on their years of school experience and project these memories and wishes into the present that they then identify with as somehow an indication of what should happen or never happen again. (p. 28-29)

Students come into our teacher preparation programs with a focus on affect. Yet, it is uncommon to talk about student emotions (with the exception of student motivation) in teacher preparation programs. For our participants, ideas about student affect were consistent major goals in their vision, even though they were rarely discussed in their coursework. They co-opted the good pedagogical practices that were intended to produce deep student understanding and learning of mathematics and embraced them because students would have desired affective responses if engaged in them. If prospective teachers are given the opportunity to talk about their future students' affect, teacher educators may be able to use the prospective teachers' desires to make students comfortable to motivate reform-oriented practices. Hence, we could leverage our prospective teachers' focus on desired student affect as a motivating factor for their engagement in and learning about desired pedagogical practices.

### **Acknowledgements**

This paper is based on work supported by the National Science Foundation under Grant No. 1149436. Opinions, findings, and conclusions in this paper are those of the authors and do not necessarily reflect the views of the funding agency.

### **References**

- Beijaard, D., Meijer, P. C., & Verloop, N. (2004). Reconsidering research on teacher professional identity. *Teaching and Teacher Education, 20*(2), 107-128.
- Britzman, D. P. (2009). *The very thought of education: Psychoanalysis and the impossible professions*. Albany, NY: State University of New York Press.
- Brown, T. (2008). Becoming a teacher. In T. Brown (Ed.), *The psychology of mathematics education: A psychoanalytic displacement* (pp. 95-117). Rotterdam: Sense Publishers.
- de Freitas, E. (2008). Troubling teacher identity: Preparing mathematics teachers to teach for diversity. *Teaching Education, 19*(1), 43-55.
- Flores, M. A., & Day, C. (2006). Contexts which shape and reshape new teachers' identity: A multi-perspective study. *Teaching and Teacher Education, 22*, 219-232.
- Freeman, M. (2010). 'Knowledge is acting': Working-class parents' intentional acts of positioning within the discursive practice of involvement. *International Journal of Qualitative Studies in Education, 23*(2), 181-198.

- Friesen, M. D., & Besley, S. C. (2013). Teacher identity development in the first year of teacher education: A developmental and social psychological perspective. *Teaching and Teacher Education, 36*, 23-32.
- Glaser, G., & Strauss, A. L. (1967). *The discovery of grounded theory: Strategies for qualitative research*. Hawthorne, NY: Aldine de Gruyter.
- Goodwin, C. (1994). Professional vision. *American Anthropologist, 96*(3), 606-633.
- Hammerness, K. (2001). Teachers' visions: The role of personal ideals in school reform. *Journal of Educational Change, 2*, 143-163.
- Hammerness, K., Darling-Hammond, L., & Bransford, J. (with Berliner, D., Cochran-Smith, M., McDonald, M., & Zeichner, K.). (2005). How teachers learn and develop. In L. Darling-Hammond & J. Bransford (Eds.), *Preparing teachers for a changing world: What teachers should learn and be able to do* (pp. 358-389). San Francisco, CA: Jossey-Bass.
- Hannula, M. (2002). Attitude towards mathematics: Emotions, expectations and value. *Educational Studies in Mathematics, 49*, 25-46.
- Lutovac, S., & Kaasila, R. (2011). Beginning a pre-service teacher's mathematical identity work through narrative rehabilitation and bibliotherapy. *Teaching Higher Education, 16*(2), 225-236.
- McLeod, D. B. (1992). Research on affect in mathematics education: A reconceptualization. In D. A. Grouws (Ed.), *Handbook of research on mathematical thinking and learning* (pp. 575-596). New York: Macmillan.
- Peressini, D., Borko, H., Romagnano, L., Knuth, E., & Willis, C. (2004). A conceptual framework for learning to teach secondary mathematics: A situative perspective. *Educational Studies in Mathematics, 56*, 67-96.
- Pillen, M. T., Den Brok, P. J., & Beijaard, D. (2013). Profiles and change in beginning teachers' professional identity tensions. *Teaching and Teacher Education, 34*, 86-97.
- Sfard, A., & Prusak, A. (2005). Telling identities: In search of an analytic tool for investigating learning as a culturally shaped activity. *Educational Researcher, 34*(4), 14-22.
- Sugrue, C. (1997). Student teachers' lay theories and teacher identities: Their implications for professional development. *European Journal of Teacher Education, 20*(3), 213-225.

# EXPLORING FRACTION COMPARISON IN SCHOOL CHILDREN

David M. Gómez, Abelino Jiménez, Roberto Bobadilla, Cristián Reyes, Pablo Dartnell

Universidad de Chile

*The application to rational numbers of the procedures and intuitions proper of natural numbers is known as Natural Number Bias. Research on the cognitive foundations of this bias suggests that it stems not from a lack of understanding of rational numbers, but from the way the human mind represents them. In this work, we presented a fraction comparison questionnaire to 502 school children from 5<sup>th</sup> to 7<sup>th</sup> grade to investigate if the Natural Number Bias succeeds in explaining their error patterns. About 25% of children responded in a way perfectly consistent with the Bias, but good students committed many errors in items that the Bias predicts to be easy. We propose an explanation based on comparison strategies and wrong generalizations of a common remark used for teaching fraction magnitude.*

## INTRODUCTION

Learning fractions is an important challenge within the middle school curriculum. Fractions are typically the very first approach of school children to number systems beyond that of natural numbers. To master fractions, students must learn new concepts, procedures, and intuitions that often contradict their accumulated knowledge of the natural number system. For instance, the multiplication of two fractions may be smaller than the intervening factors (e.g.  $1/2 \times 1/4 = 1/8$ ), and any fraction can be written in infinitely many equivalent ways (e.g.  $1/2 = 2/4 = 3/6 = \dots$ ). Many students fail to understand fractions even at the most basic levels, something problematic under the light of recent evidence linking successful learning of fractions to advanced topics like algebra (Booth & Newton, 2012). Although the lack of appropriate mathematical knowledge by many teachers is a very important factor contributing to this failure (e.g. Valdemoros Alvarez, 2010), other less evident factors may also play a relevant role.

Ni and Zhou (2005) presented a review about a particular type of frequent errors linked to the understanding of fractions. These errors seemed to stem from the generalization to fractional contexts of the concepts, procedures, and intuitions proper of natural numbers. The authors used for them the umbrella term Natural Number Bias. Typical examples associated to this bias are reasoning that  $2/3 < 2/5$  because  $3 < 5$ , as well as computing  $1/2 + 1/3 = 2/5$ , thinking that processing separately both fraction components (numerators and denominators) is enough for obtaining the desired result. Errors due to reasoning on the basis of natural number knowledge are not limited to calculation procedures: school children from 7<sup>th</sup> to 11<sup>th</sup> grade may state that there is a finite number of rationals between  $1/5$  and  $4/5$ , as if rational numbers possessed a successor (Vamvakoussi & Vosniadou, 2010). It is important to underline, as Ni and Zhou do, that these errors are not simply the result of a failed learning experience but

reflections of the deep, intuitive way in that the human mind deals with fractions even in adults who work proficiently with rational numbers. Recent investigations have demonstrated this by presenting questionnaires in which pairs of fractions such as  $2/7$  and  $5/7$ , or  $3/5$  and  $3/8$ , must be compared. These two fractions pairs may be called congruent and incongruent respectively because of the relation between the magnitude of the fractions and the magnitude of the natural numbers composing them. In this sense, in the former pair the greatest fraction has the greatest numerator so that fractional and natural magnitudes point in the same direction, whereas in the latter pair the greatest fraction has the least denominator and hence fractional and natural magnitudes point in opposite directions. When using these types of items, adults (Vamvakoussi, Van Dooren, & Verschaffel, 2012) and even expert mathematicians (Obersteiner, Van Dooren, Van Hoof, & Verschaffel, 2013) respond more slowly to incongruent fraction pairs.

The present work explores the extent to which the Natural Number Bias provides a useful account of the errors committed by a sample of 5<sup>th</sup>- to 7<sup>th</sup>-grade children in a fraction comparison questionnaire. To do this, we selected fraction pairs that allowed us to contrast explicitly the congruent/incongruent dimension. In addition, based on research on the neural processing of fractions (e.g. Barraza, Gómez, Oyarzún, & Dartnell, under review; Ischebeck, Schocke, & Delazer, 2009), we selected fraction pairs that either have or have no common components. Pairs with common components (e.g.  $2/7$  and  $5/7$ ) tend to be compared by just looking at the non-common component (see also Bonato, Fabbri, Umiltà, & Zorzi, 2007), whereas pairs lacking common components (e.g.  $2/3$  and  $1/4$ ) require different strategies such as computing cross multiplications or estimating the numerical magnitude of each fraction.

## METHODS

### Participants

Five hundred and two school children of 5<sup>th</sup> ( $n = 165$ ), 6<sup>th</sup> ( $n = 181$ ), and 7<sup>th</sup> ( $n = 156$ ) grade classes from five schools located in different areas of Santiago, Chile, participated in this study. All children were authorized by their parents' signature of an informed consent form.

### Questionnaire

We selected 24 fraction pairs grouped according to two factors: the presence or lack of common components, and congruency/incongruency (see Table 1). We classified a fraction pair  $a/b$  and  $c/d$  as congruent if  $a \leq c$ ,  $b \leq d$ , and  $a/b \leq c/d$  (or vice versa); or as incongruent if  $a \leq c$ ,  $b \leq d$ , and  $a/b \geq c/d$  (or vice versa). In other words, congruent pairs are those in which the greatest numerator and the greatest denominator both belong to the greatest fraction, whereas in incongruent pairs the greatest numerator and the greatest denominator both belong to the least fraction.

	With common components		Without common components	
Congruent pairs	4/9, 8/9	9/11, 4/11	5/7, 1/3	5/16, 12/17
	7/19, 15/19	15/17, 6/17	3/14, 9/17	10/17, 3/9
	2/11, 3/11	7/8, 4/8	2/5, 11/18	17/19, 4/9
Incongruent pairs	4/15, 4/6	1/9, 1/4	5/6, 8/19	2/4, 3/13
	5/8, 5/17	3/7, 3/14	6/13, 4/5	6/18, 5/6
	7/15, 7/10	6/14, 6/8	2/3, 5/17	4/15, 2/5

Table 1: Full item list of the fraction comparison questionnaire.

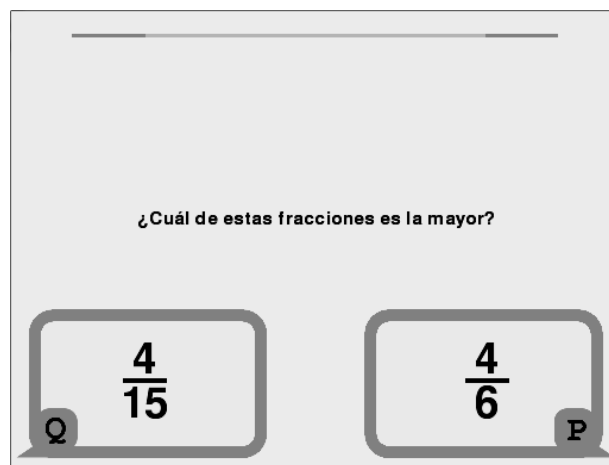

Figure 1: Screen capture of an item of the questionnaire. On top, a colored bar indicates time left for answering. At the bottom, the fraction pair to be compared.

### Mathematics achievement

We measured children's general mathematics knowledge by means of tests that their schools apply every year. As the five selected schools share a common curriculum and instructional design, these tests were the same for all schools but differed for each grade. Because of this, we normalized children's scores on a grade-by-grade basis by subtracting the average score and dividing for their standard deviation. We were only able to obtain these test scores for 451 children out of the total sample.

### Procedure

Each class was tested in the Computer Science classroom of their school. The questionnaire was presented by computer and programmed in Python+PyGame. Each child worked individually. All items presented the question "Which of these fractions is the greatest?" ("¿Cuál de estas fracciones es la mayor?") at the middle of the screen, whereas the fractions to be compared were displayed at the bottom (Figure 1). Children pressed the keys Q or P to select the left or right fraction as the greatest, respectively. Items not answered within 10 seconds of presentation were considered as omitted, and the next item was then presented. A color-changing bar on top of the screen displayed the time left for answering.

Children were aware that their outcome in this questionnaire would not have effect on their school grades. We asked them to answer each item carefully, and to follow their intuition in case of doubt.

## RESULTS

Overall mean accuracy, computed as the ratio of correct responses to non-omitted items, was 59.0% (SD = 17.6). Differences among the three grades were negligible (5<sup>th</sup> grade: 58.7%, 6<sup>th</sup> grade: 60.0%, 7<sup>th</sup> grade: 58.1%;  $F(2,499) = 0.51, p = .60$ ). Accuracy scores correlated significantly with general mathematics knowledge, with a weaker effect in 7<sup>th</sup> grade than in 5<sup>th</sup> and 6<sup>th</sup> grades (5<sup>th</sup> grade:  $r=.37, t(127)=4.5, p<.001$ ; 6<sup>th</sup> grade:  $r=.40, t(175)=5.7, p<.001$ ; 7<sup>th</sup> grade:  $r=.26, t(143)=3.2, p=.002$ ). Cronbach's  $\alpha$  was .76, suggesting a good (though not excellent) degree of internal consistency.

Table 2 presents accuracy rates per item types. A 2-way ANOVA showed a statistically significant effect of the presence or absence of common components: fraction pairs with common components were answered in average 5% better than pairs without common components ( $F(1,1503)=11.1, p<.001$ ). Congruency has a much larger effect, with congruent items being answered in average 36.7% better than incongruent items ( $F(1,1503)=505.3, p<.001$ ). There was a statistically significant interaction between these factors as well, indicating that the difference in accuracy of congruent over incongruent items was larger in fraction pairs with common components (difference for items with common components: 41.0%; without: 32.3%;  $F(1,1503)=7.0, p=.008$ ).

	With common components	Without common components	Mean
Congruent	82.2%	72.4%	77.3%
Incongruent	41.2%	40.1%	40.6%
Mean	61.7%	56.3%	59.0%

Table 2: Average scores in the fraction comparison questionnaire.

An item-per-item analysis of accuracy rates shows that this pattern of results is consistent across all 24 items of the questionnaire (Figure 2A), in close agreement with the predictions of the Natural Number Bias.

Children who were 100% accurate in congruent items and 0% in incongruent items represent extreme cases of the Bias. We observed 126 children (25.1% of the sample) that answered the questionnaire in this way: 46 in 5<sup>th</sup> grade (27.9%), 40 in 6<sup>th</sup> grade (22.1%), and 40 in 7<sup>th</sup> grade (25.6%).

To further explore our different item types, we computed item-total correlations. Figure 2B depicts correlations of all 24 individual items and the total questionnaire scores. High correlations indicate that children who answered those items correctly tend to have high overall scores, and vice versa. That is, items with high item-total correlation are considered as measuring in an appropriate way overall knowledge of

fraction comparison. Figure 2B shows several interesting features. First, all incongruent items present the highest correlations (ranging from .61 to .73) regardless of the presence of common components. This is in line with the predictions of the Natural Number Bias, which implies that incongruent items are the hardest for children. Second, congruent items with common components, that is to say fraction pairs that share a common denominator, are also positively correlated but to a smaller degree (ranging from .20 to .32). This may be due to the fact that these items are answered correctly by the vast majority of children (the average score being 82.2%), thus being unable to discriminate between children with good and bad overall scores. The final and most intriguing feature of Figure 2B is that congruent items without common components display very low or even negative correlations (ranging from  $-.35$  to  $.09$ ), signalling that these items do not align well with the rest of the questionnaire. To some extent, this reflects the large share of extremely biased children who get scores lower than average (they have overall scores about 50%) but all congruent items correct. Removing these children from the sample, however, does not alter the overall pattern (Table 3). This suggests that students with better general mathematics knowledge might be doing worse than average in these items, which indeed turns out to be the case: Students who were 1.5 standard deviations or more above average in an independent test (this amounts to 27 children out of the 451 for whom it was possible to obtain test scores) have an average score in comparing congruent items without common components of 58.0%, lower than the general average of 72.1%. Thus, top students behaved in a way opposite to the predictions of the Natural Number Bias for the case of items with no common components (their average scores in all other item types are above 80%).

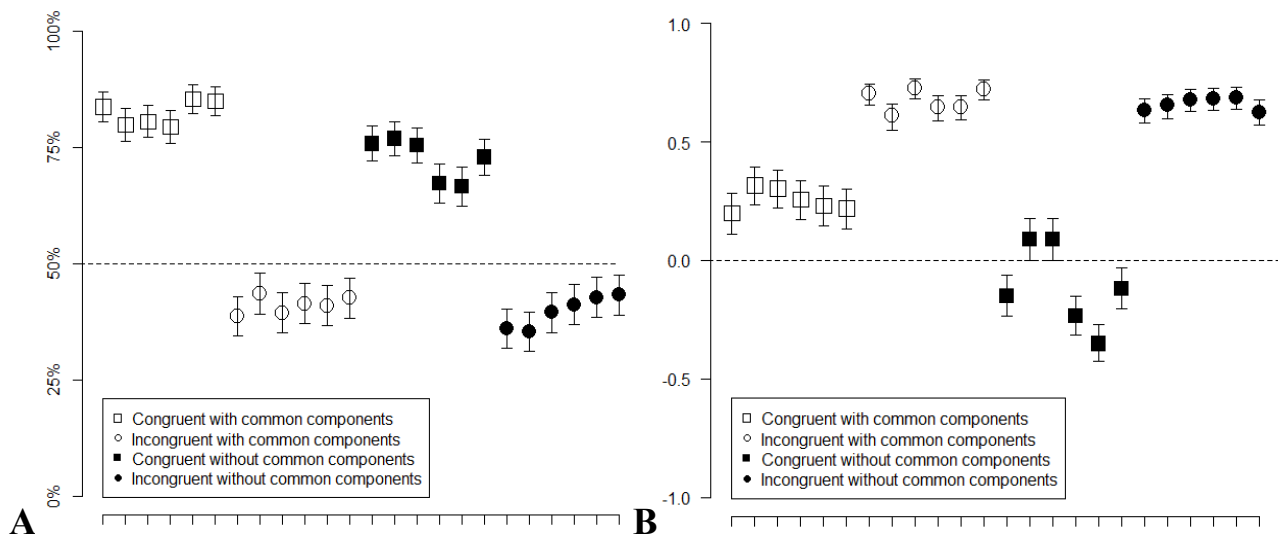

Figure 2: (A) Average scores per item. (B) Item-total correlations. Vertical bars depict 95% confidence intervals.

Item	Correlation (full sample)	Correlation (subsample)	Are the two greatest naturals part of the same fraction?
5/7, 1/3	-.15	-.05	Yes
5/16, 12/17	.09	.21	No
3/14, 9/17	.09	.21	No
10/17, 3/9	-.24	-.13	Yes
2/5, 11/18	-.35	-.27	Yes
17/19, 4/9	-.12	-.02	Yes

Table 3: Low and negative item-total correlations for congruent items without common components are observed both in the full sample and after remotion of the 126 extremely biased children. The rightmost column classifies items according to the location of the two largest natural numbers in the item.

## DISCUSSION

We presented a fraction comparison questionnaire to 5<sup>th</sup>-, 6<sup>th</sup>-, and 7<sup>th</sup>-grade children in order to explore their pattern of responses and contrast it with the predictions of the Natural Number Bias. To do this, we included fraction pairs classified as congruent or incongruent according to the relation between their correct answers and the answers that would be obtained by focusing only on the natural numbers composing them. The Natural Number Bias predicts that congruent items get higher scores systematically. Our results present both support and challenges for the Natural Number Bias account. On the full sample average, congruent items had scores substantially higher than those of incongruent items (average difference of 36.7%). Moreover, a group of about 25% of the sample and approximately equally distributed among the different grades, answered the questionnaire in total agreement with the Bias. Although our data do not allow us to distinguish whether these extreme cases are due to failures in learning fraction comparison or in retaining this knowledge, they do suggest that a sizable number of children will rely on their natural number knowledge and intuitions when facing uncertainty.

Beyond the good value of Cronbach's  $\alpha$  for our questionnaire, item-total correlations contribute importantly towards a clearer picture of children's thought processes. As expected according to the Natural Number Bias, incongruent items are highly predictive of total scores. Congruent items in general present lower correlations, even close to zero or negative in the case of items with no common components. These negative correlations are not simply due to that 25% of the sample who responded in complete agreement with the Bias, since the pattern of correlations still appears when looking at the other 75%. In an intriguing finding, we discovered that the top 6% students obtain lower than average scores in these items. Careful observation of the fraction pairs in these items shows that pairs with negative item-total correlations share



a common feature: The greatest fraction of each pair not only contains the greatest numerator and the greatest denominator, but also these two numbers were the two greatest among all naturals present in the item (Table 3). Such fraction pairs may be called “strongly congruent”, as they are a subset of congruent pairs. Our questionnaire was not designed to study them in detail, a gap that future research should explore.

How are top students thinking, that they end up performing worse than average specifically in congruent items with no common components? A first observation is that they are not applying a single method such as cross multiplication to all items without common components, because they fail in congruent items but answer correctly incongruent ones. Alternatively, they might be aware that natural numbers may be misleading in a fractional context and answering incorrectly because of an excess of caution. This account, however, also fails to explain why they do well in incongruent items without common components. Another possibility that does explain this difference is that top students might be applying a heuristic method, namely that the greatest fraction tends to be the one with the least denominator. Given our selection of fraction pairs without common components, such heuristic leads exactly to good results in incongruent items and to bad results in congruent ones. This can be seen as an overgeneralization of the common remark made by teachers that the magnitude of a fraction grows if its denominator shrinks, and vice versa. This reasoning, which is perfect when referring to a single fraction, becomes a heuristic when applied to a fraction comparison item because in this new context it may systematically lead to wrong answers.

Understanding the patterns of reasoning behind children’s answers in a test is a powerful aid for the design of pedagogical interventions. Understanding common mistakes also allows providing appropriate corrective feedback. Our work thus highlights the importance of taking into account the Natural Number Bias and its strong influence in 5<sup>th</sup>-, 6<sup>th</sup>-, and 7<sup>th</sup>-grade children. Our quantitative approach, and the large sample size considered, did not allow us to focus on subtle factors such as the variety of strategies that each child may use to solve each item (e.g. Clarke & Roche, 2009). In this sense, qualitative data would make a great complement to the data here presented and may shed light on the thinking processes of top students that lead them to perform worse than average in a specific item type.

To what extent it is possible to overcome the Natural Number Bias by means of pedagogical interventions is an open question, although recent research suggests that it is not possible to do it perfectly: Remnants of biased thinking remain in adulthood (Vamvakoussi et al., 2012) and even in expert mathematicians (Obersteiner et al., 2013). Furthermore, other researchers suggest that this Bias partly stems from the way of writing fractions and its use of natural numbers (such as “2” and “3” in “2/3”; see Kallai & Tzelgov, 2012; Mena-Carrasco, Gómez, Araya, & Dartnell, under review), a conclusion that, if true, states that the effects of the Natural Number Bias in fractional tasks is unavoidable. Pedagogical intervention could still, in this case, aim at making students aware of the faulty reasoning behind the Bias.

## Acknowledgements

The authors are grateful to the directors, teachers, families, and children of the schools participating in this research, and to Benjamín Bossi and Sergio Orellana for their help in collecting the data. This research is part of a larger project on the cognitive foundations of learning fractions, funded by Grant CIE-05 of the Programa de Investigación Asociativa PIA-CONICYT.

## References

- Barraza, P., Gómez, D. M., Oyarzún, F., & Dartnell, P. (2013). *Long-distance neural synchrony correlates with cognitive strategies to compare fractions*. Manuscript submitted for publication.
- Bonato, M., Fabbri, S., Umiltà, C., & Zorzi, M. (2007). The mental representation of numerical fractions: Real or integer? *Journal of Experimental Psychology: Human Perception and Performance*, *33*(6), 1410-1419.
- Booth, J. L., & Newton, K. J. (2012). Fractions: Could they really be the gatekeeper's doorman? *Contemporary Educational Psychology*, *37*(4), 247-253.
- Clarke, D. M., & Roche, A. (2009). Students' fraction comparison strategies as a window into robust understanding and possible pointers for instruction. *Educational Studies in Mathematics*, *72*(1), 127-138.
- Ischebeck, A., Schocke, M., & Delazer, M. (2009). The processing and representation of fractions within the brain: An fMRI investigation. *NeuroImage*, *47*(1), 403-413.
- Kallai, A. Y., & Tzelgov, J. (2012). When meaningful components interrupt the processing of the whole: The case of fractions. *Acta Psychologica*, *139*(2), 358-369.
- Mena-Carrasco, G., Gómez, D. M., Araya, R., & Dartnell, P. (2013). Congruity effects in the Numerical Stroop task and fraction comparison competence. Manuscript submitted for publication.
- Ni, Y., & Zhou, Y.-D. (2005). Teaching and learning fraction and rational numbers: The origins and implications of whole number bias. *Educational Psychologist*, *40*, 27-52.
- Obersteiner, A., Van Dooren, W., Van Hoof, J., & Verschaffel, L. (2013). The natural number bias and magnitude representation in fraction comparison by expert mathematicians. *Learning and Instruction*, *28*, 64-72.
- Valdemoros Alvarez, M. E. (2010). Dificultades experimentadas por el maestro de primaria en la enseñanza de fracciones. *Relime*, *13*(4-II), 423-440.
- Vamvakoussi, X., Van Dooren, W., & Verschaffel, L. (2012). Naturally biased? In search for reaction time evidence for a natural number bias in adults. *Journal of Mathematical Behavior*, *31*, 344-355.
- Vamvakoussi, X., & Vosniadou, S. (2010). How many decimals are there between two fractions? Aspects of secondary school students' understanding of rational numbers and their notation. *Cognition and Instruction*, *28*(2), 181-209.

# PERSONAL BELIEFS AND GENDER GAPS IN MATHEMATICS

Inés M<sup>a</sup> Gómez-Chacón<sup>1</sup>, Gilah Leder<sup>2</sup>, Helen Forgasz<sup>2</sup>

<sup>1</sup>Complutense University, <sup>2</sup>Monash University

*In this paper we report data, gathered in Madrid, Spain, from two groups aged 20-39: one group comprised pedestrians stopped in the City streets, the other consisted of university students, specifically prospective primary school teachers [PPST]. It was found that the PPST were generally more negative than members of the general public about mathematics and its importance. Overall, there was relatively little evidence of gender stereotyping, However, when found, the traditional male stereotype prevailed.*

## INTRODUCTION

The current study builds on previous work in which the views of members of the public, in Australia and Spain, were sought about studying mathematics and its relevance to career suitability for males and females. The results of the earlier study (Forgasz, Leder, & Gómez-Chacón, 2012) showed that the traditional male stereotype was still prevalent, that is, higher proportions of participants responded that “males” were more suited to studies in mathematics and/or related careers than “females”. However, gender stereotyping was less pronounced among the Spaniards. The between country differences suggest that factors in the social milieu shape individuals’ beliefs and, therefore, that the social context cannot be divorced from research on affective factors.

### Aims

To explore in greater depth which social factors seem significant contributors to views about mathematics and the still apparent gendering of mathematics as a male domain in Spain, the views of two groups were examined: members of the general public (aged 20-39) who were stopped in the streets of Madrid, and Prospective Primary School Teachers (PPST), also in the 20-39 age group. We were particularly interested in the views of the PPST group, given that one of the key influences in children’s educational lives is the teaching they receive at Primary School. The opinions or views of their teachers are likely to affect how the students learn mathematics and, as a consequence, may shape or reinforce the students’ views of mathematics and gendered views about mathematics.

### Background context

Findings from two studies – PISA 2012 and Teacher Education and Development Study [TEDS-M] (Tatto et al., 2012) – contextualise the Spanish setting.

For Spanish students, the scores on the PISA mathematical literacy tests have remained stable between 2003 (481) and 2012 (484) (Thomson, de Bortoli, & Buckley, 2013). (In 2012 the OECD average was 494.) Boys, on average, consistently scored higher

than girls on the tests: 9 points higher than girls in 2003, and 16 points higher in 2012 – one of the largest increases in the gender gap in mathematics performance among countries with data for both 2003 and 2012.

Attitudinal data gathered as part of the PISA 2012 tests (OECD, 2013) revealed differences in the responses of boys and girls – with respect to enjoyment of mathematics (girls lower than boys), worry about poor grades in mathematics (girls higher than boys), getting nervous when doing mathematics problems (girls higher than boys), believing that they are not good at mathematics (girls higher than boys).

The Teacher Education and Development Study, or TEDS-M (Tatto et al., 2012) results for Spain provide strong evidence of the benefits of pre-service teacher preparation programs at colleges and universities. Ways to improve pre-service teachers' mathematical knowledge for teaching – mathematics content knowledge and mathematics pedagogical knowledge – were identified. When teachers design learning opportunities, reflect on instructional situations, and act or react in the mathematics classroom, motivational and affective aspects of learning and instruction also need to be considered.

### **Theoretical models informing the study**

Many of the early explanatory models for gender differences in the outcomes of mathematics learning (Eccles, 1985; Leder, 1992) and more recent research findings (Baker & Jones, 1993; Halpern et al., 2007) have included societal influences (access to education, laws, and the media) and the views of significant others (parents, teachers, and peers) among the contributing factors. The items developed for the survey used in the present study are consistent with these social milieu elements – see Forgasz et al. (2012).

## **THE STUDY**

### **Samples and methods**

The two samples surveyed in the present study were: group 1 – pedestrians (N = 393), and group 2 – prospective primary school teachers (N = 272).

For the pedestrian survey, participants were drawn from nine sites in the northwest, south, and central areas of Madrid. Data collection was conducted one day a week for a two month period; a morning of approximately three hours was spent at each location. The prospective primary school teacher [PPST] survey was conducted on-line in class at university. Data were collected from students at two universities.

### **The instrument**

The instrument used for data collection was described in Leder and Forgasz (2010). It was translated into Spanish; 14 of the original items were retained (see Table 1 Q2-Q15). An additional question was added for the PPST only: Q1 – “Can you do mathematics? The 15 items represent two dimensions: personal beliefs (Q2-Q5 and Q10), and gender-stereotyped beliefs (Q6-Q9, Q11-Q15). The age and gender of

participants were also recorded. As well as the readily codeable (quantitative) responses (e.g., “yes”, “no”, “don’t know”, “boys”, “girls”, “the same”), respondents were encouraged to provide explanations for their answers. [NB. The qualitative comments were manually recorded for the pedestrian sample.]

### Analyses

For the quantitative data, frequency distributions of the responses to the items were examined and Pearson chi-square ( $\chi^2$ ) tests were conducted to identify differences in the responses of the participants from the two groups; effect sizes ( $\phi$ ) for statistically significant differences were also calculated.

For the qualitative data, the open-ended responses were closely examined and categorised; a grounded approach was adopted. The emerging themes were: attitudes towards mathematics and its learning; beliefs about personal mathematical abilities; descriptions of the process of learning mathematics; epistemology and views about the nature of mathematics; and values of mathematics education.

## RESULTS AND DISCUSSION

A summary of the quantitative differences between the two groups on Q2-Q15 is found in Table 1 (which also includes response options).

As seen in Table 1, five of the 14 items were found to be statistically significantly different by group: Q2, Q3, Q5, Q7, and Q10. Four of these (Q2, Q3, Q5, and Q10) relate to personal beliefs; the fifth (Q7) is a gender-stereotyped belief. The results are reported under the two main headings: personal beliefs, and gender-stereotyped beliefs.

Question	Response options	Pedestrians	PPST	$\chi^2$ , p-level, $\phi$
Q2 When you were at school, did you like mathematics?	Yes	289 (73.7%)	68 (25%)	155.6
	No	100 (25.5%)	202 (74.3%)	p< .001
	Average	3 (0.8%)	2 (0.7%)	$\phi=0.48$
Q3 Were you good at mathematics?	Yes	279 (71%)	57 (21%)	175.6
	No	92 (23.4%)	202 (74.3%)	p< .001
	Average	22 (5.6%)	12 (4.4%)	$\phi=0.51$
Q4 Has the teaching of mathematics changed since you were at school?	Yes	122 (31%)	95 (34.9%)	ns
	No	135 (34.4%)	80 (29.4%)	
	Don’t know	136 (34.6%)	97 (35.7%)	
Q5 Should students study mathematics when it is no longer compulsory?	Yes	222 (56.6%)	70 (25.7%)	71.7
	No	108 (27.6%)	156 (57.4%)	p< .001
	Don’t know	61 (15.6%)	43 (15.8%)	$\phi=0.3$
Q6 Who is better at mathematics, girls or boys?	Girls	53 (13.5%)	35 (12.9%)	ns
	Boys	47 (12%)	22 (11.8%)	
	Same	268 (68.2%)	185 (68%)	
	Don’t know	25 (6.4%)	20 (7.4%)	

Question	Response options	Pedestrians	PPST	$\chi^2$ , p-level, $\phi$
Q7 Do you think this has changed over time?	Yes	107 (27.4%)	151 (55.5%)	66.5 p< .001 $\phi=0.32$
	No	221 (56.5%)	73 (26.8%)	
	Don't know	59 (15.1%)	46 (16.9%)	
Q8 Who do parents believe are better at mathematics, girls or boys?	Girls	31 (7.9%)	16 (5.9%)	ns
	Boys	42 (10.7%)	29 (10.7%)	
	Same	177 (45.3%)	115 (42.3%)	
	Don't know	141 (36.1%)	111 (40.8%)	
Q9 Who do teachers believe are better at mathematics, girls or boys?	Girls	42 (10.7%)	29 (10.7%)	ns
	Boys	51 (13%)	28 (10.3%)	
	Same	222 (56.8%)	160 (58.8%)	
	Don't know	76 (19.4%)	54 (19.9%)	
Q10 Do you think that studying mathematics is important for getting a job?	Yes	223 (56.9%)	67 (24.6%)	82.3 p< .001 $\phi=0.35$
	No	101 (25.8%)	159 (58.5%)	
	Don't know	66 (16.8%)	44 (16.2%)	
Q11 Is it more important for girls or boys to study mathematics?	Girls	5 (1.3%)	4 (1.5%)	ns
	Boys	5 (1.3%)	4 (1.5%)	
	Same	352 (90%)	245 (90.1%)	
	Don't know	29 (7.4%)	19 (7%)	
Q12 Who are better at using calculators, girls or boys?	Girls	20 (5.1%)	14 (5.1%)	ns
	Boys	39 (9.9%)	27 (9.9%)	
	Same	290 (73.8%)	199 (73.2%)	
	Don't know	44 (11.2%)	31 (11.4%)	
Q13 Who are better at using computers, girls or boys?	Girls	3 (0.8%)	2 (0.7%)	ns
	Boys	123 (31.3%)	82 (30.1%)	
	Same	241 (61.3%)	169 (62.1%)	
	Don't know	26 (6.6%)	18 (6.6%)	
Q14 Who are more suited to being scientists, girls or boys?	Girls	33 (8.4%)	14 (5.1%)	ns
	Boys	18 (4.6%)	12 (4.4%)	
	Same	311 (79.1%)	222 (81.6%)	
	Don't know	31 (7.9%)	22 (8.1%)	
Q15 Who are more suited to working in the computer industry, girls or boys?	Girls	5 (1.3%)	1 (0.4%)	ns
	Boys	67 (17.1%)	47 (17.3%)	
	Same	295 (75.3%)	207 (76.1%)	
	Don't know	25 (6.4%)	15 (5.5%)	

Table 1: Frequency distributions and chi-square results (by group) for survey items

### Personal beliefs

The four items (Q2, Q3, Q5, and Q10) that were statistically significantly different revealed the following between group differences:

- Q2: an appreciation for and enjoyment of mathematics when they were at school ('like': 73.7% Ped [pedestrian group], 25% PPST; p<.001,  $\phi= .48$ )

- Q3: beliefs concerning whether they were good at mathematics (good: 71% Ped, 21% PPST;  $p < .001$ ,  $\phi = .51$ );
- Q5: beliefs about whether students should continue learning mathematics when it is no longer compulsory ('yes': 56.9% Ped, 25.7% PPST;  $p < .001$ ,  $\phi = .32$ ); and
- Q10: beliefs concerning whether studying mathematics was important for getting a job ('yes': 56.9% Ped, 24.6% PPST;  $p < .001$ ,  $\phi = .35$ )

The data in Table 1 reveal that the majority of PPST did not like mathematics (Q2), and that they did not consider themselves to be good at mathematics (Q3). When the PPST were asked the additional question, 'Can you do mathematics?' (Q1), 46.3% indicated that they could not. This is a sobering finding because these are future primary teachers who will have to teach and encourage pupils to learn mathematics.

We examined some of the explanations that participants provided for their responses to the four items (Q2, Q3, Q7, and Q10) that were statistically significant different by group. We focus on examples from the PPST sample because this group is of particular interest. As well, there were much lower proportions of positive responses from this group.

*Q2: "When you were at school, did you like mathematics?"*

Only one-quarter of the PPST indicated that they liked mathematics. Three major themes emerged in their answers: attitudes (e.g., "Mathematics is boring"), teacher influence (e.g., "I was not very good at math, I think that I did not have a good teacher"), and beliefs about personal mathematical competence and knowledge (e.g., "It seems complicated and difficult to understand"; and "It doesn't interest me and it doesn't seem useful in real life.").

*Q3: "When you were at school, were you good at mathematics?"*

Whether the PPST considered themselves good or not at mathematics (and the majority did not) was often explained in terms of getting good or bad grades in this subject. Another theme was related to the view of mathematics as "a group of rules or steps to follow". A third perspective was of mathematics being linked to negative emotions, often associated with the teacher.

*Q5: "Should students study mathematics when it is no longer compulsory?"*

The majority of the PPST group considered that the further study of mathematics beyond the time it is compulsory, should be a personal decision and would depend on whether the individual wanted to study it or not. For many PPST participants the discipline of mathematics seemed completely isolated from the real world. They did not see the need for using mathematics in everyday life. Those who thought that mathematics should continue to be studied talked in terms of only those parts which could help them become useful members of society. The more theoretical or abstract parts, they claimed, should only be taught to those students who were planning to pursue careers in which these concepts would be necessary.

*Q10: “Is studying mathematics important for getting a job?”*

Surprisingly, many participants from the PPST group did not consider mathematics to be important for getting a job or, as shown in their responses to Q5, that it should not be studied when it is no longer compulsory. Typical examples of the responses of the PPST group to question Q10 reflected a belief that only basic knowledge is necessary for daily life and mathematics was disconnected from the real world (e.g., “It depends on the level of mathematics. Obviously everyone needs to know how to add and subtract and everything. But why on earth would a baker need to work out the cubic root of an imaginary number.”).

### **Gender-stereotyped beliefs**

There were no statistically significant differences for eight of the items tapping gender-stereotyped views (Q6, Q8, Q9, Q11-Q15). The vast majority of respondents in both groups believed that it was equally important for girls and boys to study mathematics (Q11). Among the low percentages of respondents who held gender stereotyped views, there was little difference in the two groups’ response frequencies about males’ and females’ mathematical capability (Q6); perceptions of parents’ (Q8) and teachers’ (Q9) beliefs about boys’ and girls’ mathematical proficiency; about calculator use (Q12); and suitability to being scientists (Q14). However, the traditional male stereotype was evident – higher proportions responded “males” than “females” – with respect to views about computer competency (Q13) and suitability for working in the computer industry (Q15).

The only statistically significant difference between the two groups was found for Q7. A higher proportion of PPST (55.5%) than pedestrians (27.4%) believed that there has been a change over time in whether boys or girls were better at mathematics. Two factors stood out in the explanations for the beliefs of the PPST group. The first was the role of females in society. For example, one PPST wrote:

previously women did not study and instead dedicated themselves to looking after children and domestic chores, and were therefore outside the education system. Sometimes they were not able to access schooling and when they did they received a very different education to the boys, one that focused more on tasks related to running a household.

The second factor related to gender equality in the education law, which has been a decisive factor for women to access education.

### **CONCLUSIONS**

Surprisingly, substantial differences were found in the personal beliefs about mathematics and its importance between the pedestrian group and the PPST group. Disappointingly, the PPST group was more negative than the general public about mathematics, about their competence in mathematics, and about the importance of mathematics, intrinsically, and for jobs. Further research to understand the longer-term implications of the PPST’s views on student learning of mathematics, educational aspirations, and gender-stereotyped attitudes and beliefs is needed.



There was little evidence overall that either group held strong gender-stereotyped views about mathematics or related careers. The one exception was regarding males' and females' competence with computers and suitability to work in the computer industry, with both groups holding more strongly to the traditional male stereotype.

Further research is also needed to explore in depth the relationships between views such as those identified in this study and Spanish students' relatively low PISA performance and the growing gender gap in mathematics achievement between 2003 and 2012.

## References

- Baker, D. P., & Jones, D. P. (1993). Creating gender equality: Cross-national gender stratification and mathematical performance. *Sociology of Education*, 66(2), 91-103.
- Eccles, J. (1985). Model of students' mathematics enrollment decisions. *Educational Studies in Mathematics*, 16(3), 311-314.
- Forgasz, H., Leder, G., & Gómez-Chacón, I. M. (2012). Young pedestrians' gendering of mathematics: Australia and Spain. In J. Dindyal, L. P. Chen, & S. F. Ng (Eds.), *Mathematics education: Expanding horizons - Proceedings of the 35<sup>th</sup> annual conference of the Mathematics Education Research Group of Australasia* (pp. 298-305), Adelaide, SA, Australia: MERGA.
- Halpern, D. F., Benbow, C. P., Geary, D. C., Gur, R. C., Hyde, S. H., & Gernsbacher, M. A. (2007). The science of sex differences in science and mathematics. *Psychological Science in the Public Interest*, 8(1), 1-51.
- Leder, G. C. (1992). Mathematics and gender: Changing perspectives. In D. A. Grouws (Ed.), *Handbook of research on mathematics teaching and learning* (pp. 597-622). New York: Macmillan.
- Leder, G. C., & Forgasz, H. J. (2010). I liked it till Pythagoras: The public's views of mathematics. In L. Sparrow, B. Kissane, & C. Hurst (Eds.), *Shaping the future of mathematics education – Proceedings of the 33<sup>rd</sup> annual conference of the Mathematics Education Research Group of Australasia* (pp. 328-335). Fremantle, WA: MERGA.
- OECD. (2013). *PISA 2012 assessment and analytical framework. Mathematics, reading, science, problem solving and financial literacy*. Retrieved from <http://dx.doi.org/10.1787/9789264190511-en>
- Tatto, M. T., Schwille, J., Senk, S. L., Ingvarson, L., Rowley, G., Peck, R., ... Reckase, M. (2012). *Policy, practice, and readiness to teach primary and secondary mathematics in 17 countries: Findings from the IEA Teacher Education and Development Study in Mathematics (TEDS-M)*. Amsterdam, the Netherlands: International Association for the Evaluation of Educational Achievement.



# PRE-UNIVERSITY STUDENTS' PERSONAL RELATIONSHIP WITH THE VISUALISATION OF SERIES OF REAL NUMBERS

Alejandro S. González-Martín

Université de Montréal, Canada

*Our research focuses on the learning of series as a consequence of institutional choices for their teaching. Our analyses of textbooks and teaching practices led us to conjecture the existence of some implicit contract rules in the teaching of series: in particular, the teaching of series is made almost exclusively in the algebraic setting, with no importance given to visualisation or to the interpretation of visual images. The analysis of the students' responses to a questionnaire suggests that students learn series without developing any ability to visualise or to interpret images concerning series, which could have consequences on the learning of subsequent notions.*

## INTRODUCTION AND BACKGROUND

Infinite series of real numbers (*series* in what follows) are a key notion in mathematics: the idea of adding many terms was already present in ancient Greek mathematics and the use of infinite sums (either numerical or functional) allowed the development of Calculus. Series have many applications within mathematics (such as the calculation of areas by means of rectangles), and also outside of mathematics (as the modelling of situations such as the growth of interests in a bank account). These elements may explain why series are present in the introductory Calculus courses in many countries.

In Canada, each province has jurisdiction over the organisation of education and official curricula; education does not depend on the federal government. In the province of Québec, compulsory education finishes at the age of 16 and students who wish to pursue university studies need to follow two years of pre-university studies (called *collégial*) before they enter university. Students pursuing scientific or technical careers will have an introduction to Calculus during the *collégial* studies.

Research literature about the teaching and learning of series is scarce and it has mostly focused on their learning, but not on their teaching. Regarding their teaching, Robert (1982) already conjectured that teaching could have an impact in learning, and stated that the exercises used in teaching could be at the origin of the inadequate conceptions of convergence of sequences and series found in university students in France.

Regarding their learning, a summary of the main difficulties identified to learn series can be found in González-Martín, Nardi & Biza (2011). In particular, Alcock and Simpson (2004) suggest that students who regularly use visual images in their reasoning about real analysis, particularly using series and sequences, share some positive characteristics: “they all view mathematical constructs as objects, they all quickly draw conclusions about whole sets of objects, and they have confidence in their own assertions to the point of considering them obvious” (p. 29). They add that

“those who use visual reasoning effectively do so because they build strong links between the visual and formal representations of real analysis concepts” (p. 30). Their results go in the same sense than much of the existing literature about visualisation, which underlines its importance in learning and doing mathematics, as well as in reasoning (Arcavi, 2003), and its crucial importance to experts and students alike, suggesting new results or potential approaches to proofs (Presmeg, 1986).

Our literature review led us to reflect upon whether or not the teaching of series takes into account the learning difficulties identified by research, and in particular whether the use of visualisation is encouraged by teaching practices. The first stage of our research involved the analysis of how series are presented in *collégial* textbooks, identifying some possible consequences of this presentation. We analysed a sample of 17 textbooks used in *collegial* studies in Québec from 1993 to 2008 (González-Martín *et al.*, 2011), paying special attention to the organisation of teaching. Our main results can be summarised as follows:

- R1: Series are usually introduced through organisations which do not lead to a questioning about their applications or their importance (*raison d'être*).
- R2: Organisations tend to introduce series as a tool in order to later introduce functional series, but the importance of series *per se* is usually absent.
- R3: These organisations tend to ignore some of the main difficulties in learning series identified by research.
- R4: The vast majority of tasks concerning series are related to the application of convergence criteria, or to the application of algorithmic procedures.

The second stage of the research consisted in analysing *collégial* teachers' practices and use of textbooks (González-Martín, 2010). Interviews with five teachers revealed that their practices tended to mostly reproduce what was presented in their textbooks.

As a consequence of the results of these two stages, we conjectured the existence of some implicit *contract rules* in the teaching of series in the *collégial* institutions in Québec, having a strong effect on students' learning. We have discussed some of these rules in previous papers: in González-Martín (2013a) we discussed two implicit rules implying that students do not need the definition of what a series is to solve the tasks given to them, and also that applications of series are not important; in González-Martín (2013b) we discussed the implicit rule implying that the notion of convergence is reduced to the application of convergence criteria. For the purposes of this paper, as we are interested in the use of visualisation, we only discuss the following rule

*Rule 1:* “To solve the questions about series that are given, the use of visualisation (or any visual representation of series) is not necessary”.

We conjectured the existence of this implicit rule guided by our analysis of textbooks and the interviews with teachers. We found that the number of visual images used by the textbooks to teach series was very low, especially in a conceptual way (we defined a *conceptual* image as that used to explain a concept, or to illustrate one step of a proof;

it might be part of the proving process and it is explicitly intended to help the student understand a notion or a mathematical argument) (González-Martín *et al.*, pp. 572-574). In particular, the prototypical graphic representation of series used by textbooks was a variation of the image presented in Figure 1, used by textbooks in the proof of the Integral Test, which states under which conditions both  $\int_a^\infty f(x)dx$  and  $\sum_{n=1}^{\infty} f(n)$  are convergent or divergent. We noted that “these representations are not

accompanied by an account that aims to link the representation with the algebraic and other symbolic representations of the concept used in the text. [and] the authors of the texts appear to take for granted that the students will instantly establish this connection and, for example, will interpret the rectangles appearing under a curve as representing the terms of the sum within a series” (p. 574).

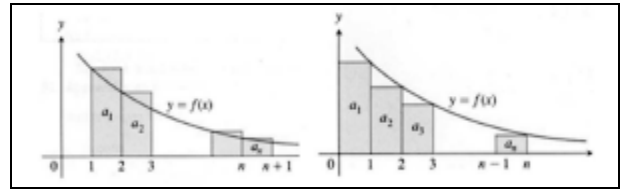

Figure 1: Prototypical representations of series found in textbooks.

We believe that *Rule 1* is a consequence of both *R3* and *R4*. The teaching of series is organised around the application of convergence criteria and algorithmic procedures (*R4*), hence activities promoting visualisation are scarce, and difficulties identified by research, as well as recommendations (as the use of visualisation), are not sufficiently taken into account (*R3*).

To verify whether *Rule 1* has an impact on *collégial* students' learning of series, we decided to create a sample of students and to apply a questionnaire. Let us define first the main elements of our theoretical framework, before clearly stating our objectives.

## THEORETICAL FRAMEWORK

Chevallard's anthropological theory develops tools to better understand the choices made by an institution in order to organise the teaching of mathematical notions, as well as the possible consequences of these choices on what an individual learns. A fundamental notion in this theory is that of *institution*; an institution *I* is defined as a social organisation which allows, and imposes, on its *subjects* (every person *x* who occupies any of the possible positions *p* offered by *I*) the development of *ways of doing and of thinking proper to I* (Chevallard, 1988/89, p. 2). For instance, a classroom is an *institution* (with two main positions: teacher and student), as well as a school, or an educational system, are also *institutions*.

To analyse how an *institution* considers a notion, further definitions are required. An *object* is any entity, material or immaterial, which exists for at least one individual; in particular, any intentional product of human activity is an *object*. Every *subject x* has a *personal relationship* with any object *o*, denoted as  $R(x, o)$ , as a product of all the interactions that *x* can have with the object *o* (using it, manipulating it, speaking of it...). This *personal relationship* is created, or modified, by entering in contact with *o*

as it is presented in different *institutions*  $I$ , where  $x$  occupies a given position  $p$ . From this *personal relationship*, a learner (if we consider an educational *institution*) will constitute what one could designate as being ‘knowledge’, ‘know-how’, ‘conceptions’, ‘competencies’, ‘mastery’, and ‘mental images’ (Chevallard, 1988/89). This notion of *relationship* is also transferred to *institutions*: given an object  $o$ , an *institution*  $I$ , and a position  $p$  in  $I$ , we define as the *institutional relationship* with  $o$  in position  $p$ ,  $R_I(p, o)$ , the relationship with the object  $o$  which should ideally be that of the subjects in position  $p$  in  $I$ . By becoming a *subject* of  $I$  in position  $p$ , an individual  $x$  is subjected to the *institutional relationships*  $R_I(p, o)$ , which in turn will re-model his/her own *personal relationships*. This *institutional relationship* is mainly forged through the exercises (or tasks), and not only through the theoretical explanations. It is also forged through the use of elements (as symbols, images...) to refer to, or to manipulate, the mathematical notions to be constructed; these elements which allow to work concretely with abstract notions are called *ostensives* (Bosch & Chevallard, 1999).

The identification of the *institutional relationship* with a mathematical notion also allows to identify the existence of (sometimes implicit) *contract rules*, which are rules that the *institution* fosters through its practices around a mathematical notion and which contribute to determine the *institutional relationship* to a mathematical notion. This *institutional relationship* and its *contract rules* play an important role in the development of the learners’ *personal relationship* with the mathematical notions s/he learns within the institution.

In our case, our objective is to have elements to characterise *collégial* students’ *personal relationship* with the visualisation of series (and the use of *ostensives* in the graphic or geometric *settings*) and to see if this *personal relationship* seems to have a strong relation with the implicit *contract Rule 1* identified in the teaching processes.

## METHODOLOGY

To verify the possible effects of *contract Rule 1*, among others, on *collegial* students’ *personal relationship* with series, we created a sample of 32 students in their first year of *collégial* studies (where series are introduced) after the teaching of series had occurred. These 32 students come from three different mathematics teachers (named as A, B and C). Our sample consists of 4 students from teacher A (referred to as students A1 to A4), 14 students from teacher B (referred to as students B1 to B14), and 14 students from teacher C (referred to as students C1 to C14).

We constructed a questionnaire with 10 questions, aiming to assess the students’ learning about series, as well as to verify our conjectures about the impact of different *contract rules* on their learning. The questionnaire was administrated in May 2011 during one of their courses (approximately 55 minutes in duration), and the students participated voluntarily.

In this paper, we discuss the students’ responses to the two following questions:

**Question 8:**

Which series is represented in the following image and which result does it allow visualising?

Describe the procedure represented in the image, and then write the series symbolically.

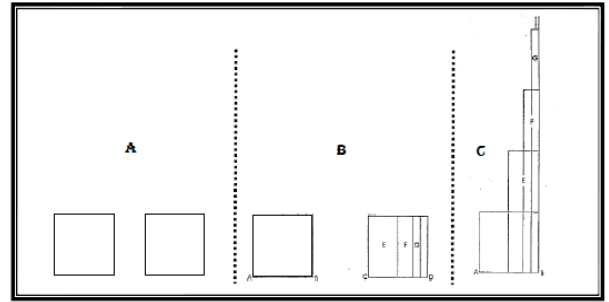

**Question 10:**

We know that  $\sum_{n=1}^{\infty} \frac{1}{n} = \infty$  and that  $\sum_{n=1}^{\infty} \frac{1}{n^2} = \frac{\pi^2}{6}$ . Taking into account

these results, what can we say about the value of  $\int_1^{\infty} \frac{1}{x} dx$  and of

$$\int_1^{\infty} \frac{1}{x^2} dx?$$

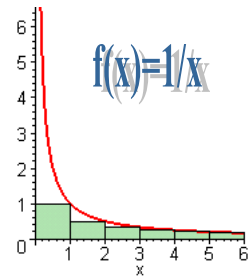

Answer this question without making any calculation, only by using the following graph or by producing another graph if needed.

Figure 2: Questions 8 and 10.

In the next section, we present and comment on the results obtained from these questions.

**DATA ANALYSIS**

**Question 8 (Q8)**

The distribution of responses to this question is the following:

<p>“A [square] is divided in half and one of the two halves is added to an initial identical [square]. Then, every remaining half is divided in two and added over the construction indefinitely”</p> $\sum_{n=1}^{\infty} 1 \cdot \left(\frac{1}{2}\right)^{n-1} = 1 + \frac{1}{2} + \frac{1}{4} + \frac{1}{8} + \dots ;$ $\sum_{n=1}^{\infty} 1 \cdot \left(\frac{1}{2}\right)^{n-1} = \frac{a}{1-r} = \frac{1}{1-\frac{1}{2}} = \frac{1}{\frac{1}{2}} = 2$	C14
<p>Describes correctly the image (“we divide a square by two, and then we re-divide it by two”), but unable to write it correctly symbolically</p>	A4 B6, B9
<p>Describes correctly the image, without attempting to write it symbolically</p>	C8
<p>“<math>\sum_{n=1}^{\infty} 1 + \frac{1}{2^n}</math>”, but I cannot explain it”</p> <p>“<math>1 + \frac{1}{2} + \frac{1}{4} + \frac{1}{8} + \dots</math>”</p>	B1 C7

Other (wrong) attempts or (wrong) explanations	B2, B5, B7, B8 C1, C3, C5, C6, C12, C13
“I don’t understand the image” “I don’t understand the question”	B13 C11
No answer / ? / “Didn’t have time”	A1, A2, A3 B3, B4, B10, B11, B12, B14 C2, C4, C9, C10

Table 1: Responses to Question 8.

These students have spent more than one week working with series and deciding the convergence or the divergence of quite complex series; however, confronted to a visual image of a simple series  $\left(\sum_{n=0}^{\infty} \frac{1}{2^n}\right)$ , only one student is able to describe it and to write it symbolically. Other four students (A4, B6, B9, C8) are able to describe it, without writing it symbolically, and two students (B1, C7) are able to write it symbolically, without describing it. Fifteen students (15/32) don’t provide any answer, or acknowledge not understanding the question or the image. These results seem to go in the sense of *Rule 1*, and as the students do not need to interpret or to manipulate any visual representation of series to solve the algorithmic tasks they are usually given, they seem not to have developed any ability helping them to tackle or to interpret this type of *ostensive*. This seems to contradict the attitude of the textbooks, which seem to take for granted that students are able to interpret visual representations of series (González-Martín *et al.*, p. 574).

### Question 10 (Q10)

The distribution of responses to this question is the following:

Explicitly uses the graph to relate the behaviour of the series to that of the integrals	None	
$\int_1^{\infty} \frac{1}{x} dx$ diverges and $\int_1^{\infty} \frac{1}{x^2} dx$ converges (explicitly or implicitly)	With no explanation	A1 B4 C2, C5, C8
	Calculates the primitives (sometimes with errors)	B8, B13 C11
	Other	A2, A3 B5, B9, B10, B12 C1, C6
Imply (verbally or symbolically) that the value of the series and the corresponding integrals are the same	B1 C13	
	A4	



Other interpretations	B6, B7, B11 C3, C7, C10, C12
No answer / “Didn’t have time” / “I don’t know”	B2, B3, B14 C4, C9, C14

Table 2: Responses to Question 10.

Again in this question, and in a more dramatic way, we see that the students are incapable of interpreting the given graph to relate the behaviour of series and integrals. However, the image used in this question should be familiar to the students, since it corresponds to the prototypical image used by textbooks to illustrate the integral test (see Figure 1). Nevertheless, even if students are supposed to be familiar with the image, and even if textbooks take for granted that students are able to interpret the image, our results seem to contradict these assumptions and the students of our sample seem to be totally incapable of interpreting and/or using the image. This image is present in the *institutional relationship* with series, but maybe because it is taken for granted, or not used in any specific task, students seem not to integrate it in their *personal relationship* with series.

## FINAL REMARKS

Our analysis of textbooks and the teaching practices led us to conjecture the presence of *contract Rule 1*: abilities related to visualisation are not developed during the teaching of series. And as we conjectured, questions needing to manipulate or to interpret visual images implying series produce a very low level of correct responses in the students of our sample, seeming to confirm the presence of *contract Rule 1*. Even if the students spend a high amount of time deciding the convergence or the divergence of quite complex series, they seem incapable of interpreting visual images referring to very simple series, and their *personal relationship with series* seems to only consider the use of symbolic *ostensives*.

The lack of development of visual abilities concerning series could have serious consequences for students’ learning, as the literature indicates: students might not develop a vision of series as objects and might not build strong links between the visual and formal representations of real analysis concepts (Alcock & Simpson, 2004), and they might also not develop adequately some reasoning abilities (Arcavi, 2003).

The results presented here, together with those shown in González-Martín (2013a, 2013b) seem to confirm the presence of *contract rules* influencing students’ learning of series: they use series without being able to define them, or without knowing what they are useful for, reducing the notion of convergence to the application of criteria, and not developing abilities of visualisation and interpretation of series. These elements seem to be very clear in students’ *personal relationship* with series, and this seems to be a consequence of the *institutional relationship* with series, which fosters the presence of the *contract rules*. The impact for the learning of subsequent notions seems too dramatic to be ignored, and research aiming to change this *institutional*

*relationship* with series and, as a consequence, students' *personal relationship* with series appears to be urgent.

### Acknowledgements

This research has been funded by the program *Nouveau chercheur du Fonds Québécois de Recherche sur la Société et la Culture* (FQRSC) – ref. 128796. The author would also like to thank Sarah Dufour for her help in the compilation of data.

### References

- Alcock, L., & Simpson, A. (2004). Convergence of sequences and series: interactions between visual reasoning and the learner's beliefs about their own role. *Educational Studies in Mathematics*, 57(1), 1-32.
- Arcavi, A. (2003). The role of visual representations in the learning of mathematics. *Educational Studies in Mathematics*, 52(3), 215-241.
- Bosch, M., & Chevallard, Y. (1999). La sensibilité de l'activité mathématique aux ostensifs. Objet d'étude et problématique. *Rech. en Didactique des Mathématiques*, 19(1), 77-124.
- Chevallard, Y. (1988/89). *Le concept de rapport au savoir: Séminaire de didactique des mathématiques et de l'informatique*. Grenoble: Université J. Fourier.
- González-Martín, A. S. (2010). The concept of series: teachers' conceptions and teaching practices. In M. M. F. Pinto & T. F. Kawaski (Eds.), *Proc. 34<sup>th</sup> Conf. of the Int. Group for the Psychology of Mathematics Education* (Vol. 3, pp. 33-40). Belo Horizonte, Brazil: PME.
- González-Martín, A. S. (2013a). *Students' personal relation to series of real numbers as a consequence of teaching practices*. Paper presented at the 8<sup>th</sup> Congress of European Research in Mathematics Education (CERME8), Antalya, Turkey. Retrieved from [http://www.cerme8.metu.edu.tr/wgpapers/WG14/WG14\\_Gonzalez\\_Martin.pdf](http://www.cerme8.metu.edu.tr/wgpapers/WG14/WG14_Gonzalez_Martin.pdf).
- González-Martín, A. S. (2013b). Students' personal relationship with the convergence of series of real numbers as a consequence of teaching practices. In A. M. Lindmeier & A. Heinze (Eds.), *Proc. 37<sup>th</sup> Conf. of the Int. Group for the Psychology of Mathematics Education* (Vol. 2, pp. 361-368). Kiel, Germany: PME.
- González-Martín, A. S., Nardi, E., & Biza, I. (2011). Conceptually-driven and visually-rich tasks in texts and teaching practice: the case of infinite series. *International Journal of Mathematical Education in Science and Technology*, 42(5), 565-589.
- Presmeg, N. C. (1986). Visualisation and mathematical giftedness. *Educational Studies in Mathematics*, 17(3), 297-311.
- Robert, A. (1982). L'acquisition du concept de convergence des suites numériques dans l'enseignement supérieur. *Recherches en Didactique des Mathématiques*, 3(3), 307-341.

# THE INFLUENCE OF GRAPHICS IN MATHEMATICS TEST ITEM DESIGN

Jane Greenlees<sup>1</sup>, Tracy Logan<sup>1,2</sup>

<sup>1</sup>Charles Sturt University, Australia, <sup>2</sup>University of Canberra, Australia

*This study investigated the performance and reasoning of 143 Australian students who completed mathematics tasks sourced from their national test. Specifically, this study examined changed student performance and reasoning on items where the graphic component was modified. The results of the study revealed significant performance differences between the original and modified items and provided insight into how these modifications influenced student reasoning.*

## GRAPHICS IN TEST ITEMS

The design of mathematics test items has received heightened attention recently. For example, the United States National Mathematics Advisory Panel (2008) made the following recommendation in regard to items used in both national and state achievement tests:

More research is needed on test item design features and how they influence the measurement of the knowledge, skills, and abilities that students use when solving mathematics problems on achievement tests. (p. 61)

In light of such advice, this study aimed to outline what semi-structured interviews and survey data revealed about the influence of a graphic in the design of numeracy test items and the impact these graphics had on student performance and reasoning.

In deconstructing mathematics test items, Lowrie, Diezmann and Logan (2012) found that, typically, many assessment items consisted of three elements that organised mathematical information: text, symbols, and graphics. This paper will focus on the graphic component of test items. Bertin (1967/1983) defined graphics as visual representations for “storing, understanding and communicating essential information” (p. 2). Within the context of this study, graphics refers to any diagram, pictorial representation or graph used within a test item. The graphics in these items can be classified under two distinct categories, contextual and information. Contextual graphics are used for illustrative purposes, usually to provide a context for the written text. In contrast, an information graphic presents mathematical information in a visual-spatial form that supplements the text and symbols and is essential for task solution (Diezmann & Lowrie, 2008).

According to Lowe and Promono (2006), “test and graphic have long been combined in various ways to provide complementary sources of information and on a wide variety of topics” (p.22). This dual use of text and graphics has resulted in cognitive load theory (CLT) becoming more prominent within assessment design and how the

components within an item may impact on working memory (Sweller, 1999). CLT was examined with respect to multimedia learning and the impact of inappropriate and unnecessary graphics. Within this research Mayer and Moreno (2002) identified four design principles to aid students in learning more deeply and preventing the overloading of their visual and/or verbal working memories. These included the notion of contiguity, coherence, modality, and redundancy. Of particular relevance to mathematics assessment was the coherence and redundancy principles. With regard to the coherence principle, it was found that students “learn more deeply when they do not have to process extraneous words or sounds in verbal working memory or extra pictures in visual working memory” (Mayer & Moreno, 2002, pp. 116-117). Bobis, Sweller and Cooper (1993) explored the notion of the redundancy principle, finding a possible redundancy of some graphics within an item but also a necessity for graphics in other items in regards to cognitive load.

Within the Australian context, there has been research conducted on the influence of graphics in mathematics test items on student reasoning (e.g., Diezmann & Lowrie, 2012; Logan & Greenlees, 2008). Much of the findings highlight the difficulty students have interpreting and decoding the graphic presented in the item. Lowrie and Diezmann (2009) argued that decoding graphics is a skill that is seldom taught and that primary school-aged students often find such representations overloaded with information and therefore difficult to interpret. Indeed, they found that test item design had considerable impact on how students solved tasks and that many errors:

involved students not considering information in the graphic, being overly influenced by information (often irrelevant information) in the graphic, or not considering the connections between embedded graphical information and the textual and symbolic information (p. 153).

Schnotz (2002) also suggested that students will often pay only brief attention to the graphic, thinking that their general knowledge will suffice. However, students need to have a “schema-driven analysis” (p. 116) activated through explicit teaching before they can engage with the graphic content sufficiently. Therefore, it is critical that further research is undertaken on test item design in order to better understand the construction of these items and the processes required to decode them.

## **THEORETICAL FRAMEWORK**

Utilising Lowrie, Diezmann and Logan’s (2012) framework, items in the study were deconstructed according to the elements of text, symbols and graphics. This framework has been identified as a useful method to recognise the necessary elements that make up the composition of a graphical task and how the individual elements of a graphical task influenced students’ reasoning. By recognising these three elements holistically and individually, Lowrie, Diezmann and Logan identified the influential role the graphic element played in students’ sense making. Following on from these findings, this study focussed on the graphic element and specifically, the principles of coherence and redundancy in relation to contextual and information graphics.

## RESEARCH DESIGN AND METHODS

This study is part of larger investigation that focused on the impact of test item design on student's performance and sense making. These design elements included the use of text, symbols and graphics. The 15 items used were sourced from the 2010 Year 5 National assessment and were selected based on their relevance to the particular design elements. An item modification process was undertaken, which resulted in the 15 items being modified according to the text, symbols or graphics. We ensured that variations to the respective elements of the standard items would achieve the same grade-level content whilst still allowing for variations in task design (Kettler, Elliott, & Beddow, 2009). The resulting item design modification produced three items with graphical modifications, which became the focus of this paper.

Due to the test items with modified graphics being administered only one week after the original test, we made minor modifications to the wording or contexts of the items. It was anticipated that students may remember answers they gave from the first interview and ignore the changes made to the items within the second interview. Therefore, one of the limitations of this process was that modified items could not be an exact match to the original items. For this paper, the focus was on modification to the graphic component of test items, both contextual and information graphics. The research questions for this paper were:

1. Does modification to the graphic component of test items impact on students' performance?
2. How does the graphic component of test items influence student's reasoning?

### The Participants

The inquiry took place in four Australian primary schools in the state of New South Wales. The schools were diocesan Catholic primary schools for children aged 5-12 years. The students were in Year 5, and were aged 10 or 11 years. Altogether, 143 students were involved over a three-year period: 106 in the testing cohort and 37 in the interview cohort.

### Data Collection and Analysis

The following section describes the four phases of the study over a four-week period.

*Phase 1.* The original 15-item test was administered to 106 students. It is important to note that the numeracy items from the national test were used as 'representative' mathematics items suitable for students in primary schools. (week 1)

*Phase 2.* Using the original 15-item test, one-to-one interviews were conducted with 37 students purposively selected by the teachers to be representative of the classes. The interviews provided the students with the opportunity to solve the 15 items and describe their thinking strategies and solutions. (week 2)

*Phase 3.* Using the interview data obtained in phase 2, the 15 test items were modified (see Figure 1 for item modification) according to three design elements that were

particularly influential in the student’s solution process. The modified test was then administered to the 106 students. The cohort’s performance between the two tests was then analysed. (week 3)

*Phase 4.* The modified test was administered to the 37 interview participants to identify any changes in mathematical reasoning. Their responses were viewed as representative of the larger cohort. (week 4)



	The original test	The modified test
Garden Plan item	<p>This is the plan of a garden.</p>  <p>What is the perimeter of the garden?</p> <p>36 m      64 m      68 m      72 m</p> <p><input type="radio"/>      <input type="radio"/>      <input type="radio"/>      <input type="radio"/></p>	<p>This is the plan of a garden.</p>  <p>What is the perimeter of the garden?</p> <p>36 m      64 m      68 m      72 m</p> <p><input type="radio"/>      <input type="radio"/>      <input type="radio"/>      <input type="radio"/></p>
Shoe item	<p>This is a picture of a shoe.</p>  <p>Which of these is closest to the length of a real shoe?</p> <p>5 cm      25 cm      75 cm      100 cm</p> <p><input type="radio"/>      <input type="radio"/>      <input type="radio"/>      <input type="radio"/></p>	<p>Which of these is closest to the length of <b>your</b> shoe?</p> <p>5 cm      25 cm      75 cm      100 cm</p> <p><input type="radio"/>      <input type="radio"/>      <input type="radio"/>      <input type="radio"/></p>
Liquorice allsort item	<p>This lolly is made with equal layers. The layers are white or black.</p>  <p>What fraction of the lolly is made of black layers?</p> <p><math>\frac{2}{5}</math>      <math>\frac{1}{2}</math>      <math>\frac{2}{3}</math>      <math>\frac{3}{5}</math></p> <p><input type="radio"/>      <input type="radio"/>      <input type="radio"/>      <input type="radio"/></p>	<p>A cake is made with five equal layers. The layers are two white and three pink.</p> <p>What fraction of the cake is made of white layers?</p> <p><math>\frac{2}{5}</math>      <math>\frac{1}{2}</math>      <math>\frac{2}{3}</math>      <math>\frac{3}{5}</math></p> <p><input type="radio"/>      <input type="radio"/>      <input type="radio"/>      <input type="radio"/></p>

Figure 1: The original and modified tasks

## RESULTS AND DISCUSSION

### The Impact of Modifying Graphics on Students’ Performance

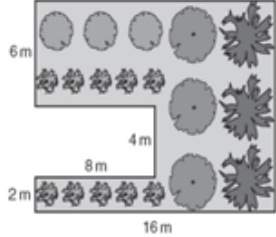
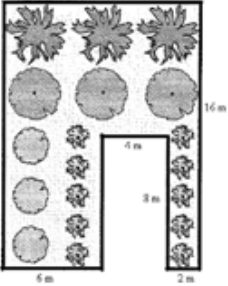
In this paper, we identified three items where the graphics were highly influential on students’ reasoning in the first phase of interviews. The analysis of variance indicated

that there was a statistically significant difference for items when a graphic was repositioned as well as when a contextual or an information graphic was taken away (see Table 1). For the Garden plan and the Shoe items, student performance increased on the modified item. However, for the Liquorice allsort item, performance declined from 92% to 83% on the modified item. Noteworthy is the observation that performance decreased when the information graphic was removed. To better understand why these changes might have occurred, the interview data was analysed.

Item Name	Modification	Original test	Modified test	F (df 1,285)
		N = 143	N = 143	* $p \leq 0.05$
Garden plan	Repositioning of graphic	33%	47%	5.91* p = .016
Shoe	Contextual graphic removed	78%	88%	4.96* p = .027
Liquorice allsort	Information graphic removed	92%	83%	4.62* p = .032

Table 1: Modifications, Percentage Correct, and Univariate Analysis of Graphics Items

### The influence on student reasoning

*Repositioning graphic within the item:* In the Garden plan item, the presentation and layout of the question was modified by centering and rotating the graphic to a more prominent position (see Figure 1). The analysis of the interview data revealed that the students seemed to overlook incorporating all sides into calculating the perimeter on the original item, possibly due to its close positioning to the question stem and answers. This was in spite of the fact that when asked the definition of a perimeter all students correctly described it as the distance all around the shape. An example of this can be seen in Elise's response to the original item when questioned on how she got the Answer A (36m).

Elise: I added them all together and then I did partners to 10. So I did 16 and 4 and 8 and 2 and that equalled 30 and I added the 6.

Int: What does perimeter mean?

Elise: The outside of an object.

By moving the graphic away from the clutter in the modified item, the interview carried out one week later revealed a heightened awareness to include all sides in the equation as evident in Elise's response (72cm):

Elise: I added all the ones and the ones where there wasn't any numbers like I knew that would be 8 because that's the same as that one and that would be 16 and for that one there was a gap down here so I put 6 and 4 together and that's 10 and then 2 for 12.

A number of students, who answered the item incorrectly in phase 2, reported similar processing on the modified item. This indicated that the format of the original item impacted on the visibility of the information necessary to solve the task. By placing the graphic too close to the question, the students may have failed to notice the requirement to include those sides that had no numerical value attributed to them. However, when all sides of the graphic were clearly visible, they could effectively determine their value and include them within the perimeter. Hence, the location of the graphic within an assessment item affected the coherence of the graphic in terms of its readability and impacted on students' ability to process and utilise the information contained within the question. We also acknowledge the potential benefits of rotating the graphic into a vertical position, given current research has suggested this is a preferred orientation (Giannouli, 2013).

*Contextual graphic removed:* The Shoe item was modified by taking away a contextual graphic (see Figure 1), meaning that the graphic did not contain information needed to solve the question. This modification was made because nearly one-third of the interview students made reference to the picture of the shoe despite its irrelevance to obtaining the answer in phase 2. It appeared that the picture of the shoe was distracting the children from analysing the question logically. The original item that students could not relate to directly, required them to estimate the length of a 'real' shoe by providing a picture of a shoe that was not to scale and ambiguous in nature. The modified item also required the students to estimate the length of a 'real' shoe but this time providing a more meaningful context by directing them to look at their own shoe.

For example, it could be perceived from her response to the original item that Mikayla did not have a sound understanding of measurement by considering a shoe to be close to 75cm. However, when investigated further it was revealed that there were aspects of the question that were negatively impacting on her mathematical reasoning.

Mikayla: Well 5cm is too small for a real shoe and 25cm is sort of a bit small too. 75cm would probably be the size of a real shoe and 100cm would be too big.

Int: So did the picture of the shoe help you work out your answer?

Mikayla: Yeah.

Int: How did it help you?

Mikayla: Well if it had been a picture of a baby shoe it would have been 5cm but because it was a picture of an adult shoe it was 75cm.

In contrast, the modified item revealed that Mikayla's measurement knowledge was in fact quite acceptable once the distraction was removed and a more accurate context created:

Mikayla: Because 5cm is too small to be my shoe and 75cm is too big and same as 100cm and 25cm was just about the right size.



Often contextual graphics are added as cues to the context or as possible forms of motivation and elaboration (Shimada & Kitajima, 2006). However, in this instance, the graphic was redundant for the purposes of problem solving and not necessary. Despite this, students were inappropriately attempting to include this in their problem solving strategies. For this reason test designers need to re-evaluate their good intentions of including such a graphic and the necessity of its inclusion.

*Information graphic removed:* The Liquorice allsort item was modified by excluding the information graphic and replacing it with written data (see Figure 1). The interview data suggested that the decrease in student performance on the modified item was due to their inability to visualise the cake using the information given. Many of the students were focusing on the numbers included in the question and were not focusing on the part-whole relationship of the fraction. Misunderstandings of the requirements of the question became more apparent in the modified version. This was particularly evident in Kyle's responses to both items:

Int: [original item] How did you get your answer?

Kyle: Well at first I thought it was 2 out of 3 because there's 2 black layers but then I looked at the lolly and saw there was 5 layers not 3 so then I chose 2 out of 5.

Int: [modified item] How did you get your answer?

Kyle: I chose 2 out of 3 because there's 2 white layers and 3 pink and that's how I worked it out.

In his response to the original item, the information graphic actually prompted Kyle to think about the part-whole relationship. It was therefore more effective to represent this type of information to students as a graphic rather than a word problem. Removing the lolly graphic could have resulted in heightening the cognitive load placed on the students during the problem solving process, as they now needed to visualise what the cake looked like. Because of this, the information graphic was not redundant but rather a necessary component of the task. However, we acknowledge that students of this age should be able to generate their own representations also.

## CONCLUSION

The research findings reinforced the need for further analysis and investigation into the different components of mathematics assessment items, in particular, the graphics. This includes a more comprehensive understanding about the differentiation between redundant graphics that are unnecessary to students and those that are not. It may be the case that contextual graphics have no role to play in high-stakes testing since such graphics are by definition contextual and therefore not necessary to the task at hand. However, the use of information graphics actually lightened the cognitive load for the students. Another consideration is the placement and layout of the graphic within an item and the impact this may have on the coherence and visibility of information available to the students. It could be the case that the inclusion of more "white space"

and orientation of the graphic is influential in student performance and reasoning. These findings highlight the effect the slight change in test item design can have on students' understanding and reasoning.

## References

- Bertin, J. (1983). *Semiology of graphics*. (W. J. Ber, Trans.). Madison, WI: The University of Wisconsin Press. (Original work published 1967)
- Bobis, J., Sweller, J., & Cooper, M. (1993). Cognitive load effects in a primary-school geometry task. *Learning & Instruction, 3*, 1-21.
- Diezmann, C. M., & Lowrie, T. (2012). Learning to think spatially: What do students 'see' in numeracy test items? *International Journal of Science and Mathematics Education, 10*, 1469-1490.
- Giannouli, V. (2013). Visual symmetry perception. *Encephalos, 50*, 31-42.
- Kettler, R. J., Elliott, S. N., & Beddow, P. A. (2009). Modifying achievement test items: A theory-guided and data-based approach for better measurement of what students with disabilities know. *Peabody Journal of Education, 84*(4), 529-551.
- Logan, T., & Greenlees, J. (2008). Standardised assessment in mathematics: The tale of two items. In M. Goos, R. Brown, & K. Makar (Eds.), *Navigating currents and charting directions – Proceedings of the 31<sup>st</sup> annual conference of the Mathematics Education Research Group of Australasia* (Vol. 2, pp. 655-658). Brisbane, QLD: MERGA.
- Lowe, R. K., & Promono, H. (2006). Using graphics to support comprehension of dynamic information in texts. *Information Design Journal (IDJ), 14*(1), 22-34.
- Lowrie, T., & Diezmann, C. M. (2009). National numeracy tests: A graphic tells a thousand words. *Australian Journal of Education, 53*(2), 141-158.
- Lowrie, T., Diezmann, C. M., & Logan, T. (2012). A framework for mathematics graphical tasks: The influence of the graphic element on student sense making. *Mathematics Education Research Journal, 24*(2), 169-187.
- Mayer, R. E., & Moreno, R. (2002). Aids to computer-based multimedia learning. *Learning and Instruction, 12*, 107-119.
- National Mathematics Advisory Panel. (2008). *Foundations for success: The final report of the National Mathematics Advisory Panel*. Washington, DC: US department of Education. Retrieved from <http://www2.ed.gov/about/bdscomm/list/mathpanel/report/final-report.pdf>
- Schnotz, W. (2002). Towards an integrated view of learning from text and visual displays. *Educational Psychology Review, 14*(1), 101-120.
- Shimada, H., & Kitajima. (2006). Why do illustrations promote text comprehension? Motivation effect and elaboration effect. In *Proceedings of 5<sup>th</sup> International Conference of the Cognitive Science* (pp. 185-186). Red Hook, NY: Curran Associates Inc.
- Sweller, J. (1999). *Instructional design in technical areas*. Camberwell, VIC: The Australian Council for Educational Research.

# INVESTIGATING STUDENTS' GEOMETRICAL PROOFS THROUGH THE LENS OF STUDENTS' DEFINITIONS

Aehsan Haj Yahya<sup>1</sup>, Rina Hershkowitz<sup>2</sup>, Tommy Dreyfus<sup>1</sup>

<sup>1</sup>Tel Aviv University, <sup>2</sup>Weizmann Institute of Science

*We present the second stage of a study within the context of geometry, whose aim is to investigate relationships between and influence of visualization, the concept images of students concerning geometrical concepts and their definition, and students' ability to prove. We focus on links between the understanding of the definition's role in concluding the geometrical concept attributes and proofs that deal with these attributes. We exemplify this stage in our research, by means of examples, which reveal that the difficulties students have in understanding the geometric concepts' definitions affect the understanding of the proving process and hence the ability to prove.*

## INTRODUCTION AND BACKGROUND

The research reported here is part of a larger study aimed at investigating: 1) the effect of visualization and of students' concept images on students' construction of geometrical concepts and their definitions; 2) the effect of definitions on students' ability to prove in geometry, and 3. the effect of visualization and concept formation difficulties on students' ability to prove in geometry. At the previous PME conference we reported on findings from investigating point 1 (Haj-Yahya & Hershkowitz, 2013). In this research report we focus mainly on findings concerning point 2.

The research literature includes many studies on the meaning of proof for students (e.g. Fischbein & Kedem, 1982) and on their ability to prove in geometry (e.g. Martin, McCrone, Bower & Dindyal, 2005). But little research was done concerning the effect of definitions on proving in geometry. Moore (1994) investigated the ability to prove concerning non-geometrical concepts. His participants were university students. He found that the superficial understanding of concept definitions and images prevented students from starting proofs and from seeing the overall structure of a proof. Edwards and Ward (2004) found that students have a tendency to rely on their concept images instead of the related concepts. Again their research context was non-geometrical concepts. It is especially surprising that there is so little research attempting to investigate the relationship between definition and proving in geometry, while school curricula in many countries dedicate most of the time devoted to learning geometry in high school to the subject of definitions and proofs. The present research attempts to fill this gap.

## THE STUDY (SECOND STAGE)

At the previous PME conference, we exemplified our findings concerning point 1 above, by means of paradigmatic examples, which reveal students' visual and verbal processes related to construction of geometric figures and inclusion relationships between groups of figures and their attributes. Our results confirmed known findings, for example that the position of a shape affects its identification and the related inclusion relationships (e.g., Hershkowitz, 1989) and also pointed to findings in a new direction, such as the effect of the question's representation on students' responses concerning the inclusion relationships. Here we focus on the role of definitions in processes of geometrical proving.

### Population

The participants are 90 students from a regional high school in an Arab community in the centre of Israel, all of whom participated in stage 1 of the research. They learn geometry with three different teachers in three parallel classes, which are considered to be at the highest mathematical level among the seven parallel classes in this school. All teachers have a first degree in mathematics from the universities in the country and more than ten years of experience in teaching mathematics.

### Methodology

The main research tools of the three-stage research include three questionnaires, one for each stage. The questionnaires were administered at time intervals sufficient for analyzing the results of each questionnaire and use its findings in the design of semi-structured interviews with about 10% of the study participants, and in the design of the next stage questionnaire for the whole population. The questionnaire used in this 2<sup>nd</sup> stage of the study deals with defining and proving (related to quadrilaterals). After administering the questionnaire and analyzing its results, nine students were interviewed.

In the tasks of this questionnaire the students were asked to "reflect on other students' answers". During such reflection, students had opportunities to use *critical thinking*; they test the proof made by the "other student". Also, while students are required to explain their responses, they uncover some of their views and knowledge regarding proving processes. Detailed analyses of a few questionnaire tasks and of students' responses are given in the next section.

## DATA COLLECTION, ANALYSIS AND FINDINGS

The data of the second stage were collected in 2013, while the participants were in the grade 11. Questionnaire 2 includes 5 tasks and was administered at the end of the first semester. In the following, we focus on and analyse data from the participants' responses to three tasks in this questionnaire.

**The Trapezium Task** (Figure 1): In the Trapezium Task we provided an insufficient proof, given supposedly by a student called Ramie. The students were asked to check

the proof's correctness and to explain their responses. The aim of this task is to examine whether the students pay attention to a missing step in a given proof. This task was designed because while analysing the first questionnaire we found that only 27% of the participants gave a correct definition of trapezium. In our curriculum, a trapezium is defined as a quadrilateral with exactly one pair of parallel sides.

*Trapezium: is a quadrilateral with only one pair of parallel sides.*

Problem:  $ABCD$  is a given parallelogram,  $E$  and  $H$  are on the continuation of sides  $CD$  and  $AB$ , respectively.  $EH$  intersects  $AD$  and  $BC$  at points  $F$  and  $G$ , respectively.

Prove that  $ABGF$  is a trapezium.

*Here is Ramie's proof:  $ABCD$  is a parallelogram, therefore  $AD$  and  $BC$  are parallel.  $BG$  is part of  $BC$  and  $AF$  is part of  $AD$ , hence  $AF$  and  $BG$  are parallel (parts of parallel sides). We found a pair of opposite parallel sides, therefore  $ABGF$  is a trapezium.*

Did Ramie give a correct and complete proof? Explain your response!

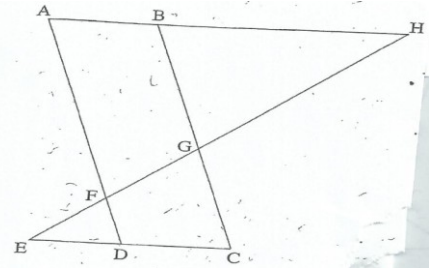

Figure 1: The Trapezium Task

Explanation \ Student's claim	No explanation	Should prove that the other pair of sides intersect	The shape could be: parallelogram, rhombus...	According to the drawing the other two sides intersect	Use insufficient definition of the trapezium	Use incorrect definition of the trapezium	Total
No claim	2 (2.2%)	0	0	0	1 (1.1%)	1 (1.1%)	4 (4.4%)
Correct & complete proof	3 (3.3%)	12 (13.3%)	1 (1.1%)	1 (1.1%)	37 (41.1%)	3 (3.3%)	57 (63.3%)
Incomplete proof	1 (1.1%)	14 (15.5%)	10 (11.1%)	0	3 (3.3%)	1 (1.1%)	29 (32.2%)
Total	5 (6.6%)	26 (28.9%)	11 (12.2%)	1 (1.1%)	41 (45.5%)	5 (5.5%)	90 (100%)

Table 1: Participants' responses to the Trapezium Task

Table 1 shows that 63% of the participants claim that the proof is correct & complete, and yet the majority (65%) of them based their justifications on an insufficient definition for trapezium. E.g. student a13 wrote: *Ramie's proof is correct, he found and proved that there is a pair of parallel sides*. It is very interesting to see that there are 12

students (13%) who claimed that the proof is correct, although they wrote that Ramie should prove that the other sides are intersect, they paid attention to the proof incompleteness, but their final answer was not consistent with their argument. Only 32% of the students claimed that the proof is incomplete, whereas about half of them explained explicitly that Ramie should prove that the other pair of sides intersect; e.g. student b43 wrote: *not correct because it is incomplete (proof process), he should prove that the other pair are not parallel, AB is not parallel to FG because they intersect in point H*. About one third of the students in this category explained that without completing the proof, the shape could be a different one (not a trapezium). E.g. b41 claimed that when we accepted this proof, parallelogram considered as trapezium because there is one pair parallel sides in parallelogram, he wrote: *No, Ramie's proof is correct but not complete. This definition fits other concepts, for example it fits a parallelogram*. We may conclude that here we have evidence that many students are not consistent concerning incomplete proof although the correct definition given at the top of the task states explicitly that there is only one pair of parallel sides.

**The Parallelogram Task (Figure 2):** This task deals with a proof that a certain quadrilateral is a parallelogram. This may be done by showing that each pair of opposite sides are parallel, or that each pair of opposite sides are equal, or that there is one pair of opposite sides which are equal and parallel. In each case the proof is sufficient. We represented a *non-economical proof*. This task was inserted into this stage, because after analyzing the first questionnaire we realized that students have a tendency to give a *non-economical definition* for the parallelogram.

*ABCD* is quadrilateral, E is in the middle of AB, G in the middle of DC, F in the middle of AC and H in the middle of BD.

Prove that HEFG is parallelogram.

Ahmed wrote the following proof:

***We can see that FE and GH are mid-segments in triangles ABC and DBC, respectively, thus because of the mid-segment attributes we can conclude that***

$$GH = FE = \frac{1}{2}BC \text{ and } GH \text{ is parallel to } FE.$$

***Remains to prove that the other sides are equal and parallel. HE and GF are mid-segments in triangles ADB and ADC, respectively. Therefore we can conclude that***

$$GF = HE = \frac{1}{2}AD \text{ and } GF \text{ is parallel to } HE. \text{ We have proved}$$

***that there are two pairs of opposite sides equal and parallel, therefore the shape is parallelogram.***

Do we need all the steps Ahmad made? If so explain why, if not what steps can be omitted?

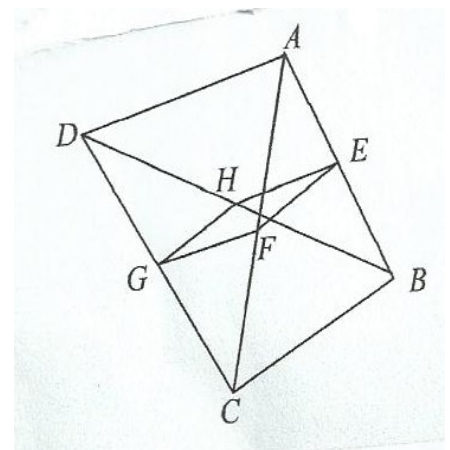

Figure 2: The Parallelogram Task

The results in Table 2 indicate that the tendency to give a non-economical definition for a parallelogram appears to have an influence on the process of proving, and many

students adopt the non-*economical proof*: 57% of all students claim that all the steps are necessary.

Only 37% of the participants wrote that there are superfluous steps in the proof, and 75% among these students explained their response by using an economical definition; e.g. a16 wrote: *It is not necessary to do all the steps. Ahmed could only prove that one pair of sides are equal and parallel.*

Explanation	Didn't explain	Used an economical definition	Used non-economical definition	Used insufficient definition	Tautology	Wrote unrelated things	Total
Student's claim							
Didn't claim	4 (4.4%)	2 (2.2%)	0	0	0	0	6 (6.6%)
All steps are necessary	21 (23.3%)	4 (4.4%)	4 (4.4%)	0	4 (4.4%)	18 (20%)	51 (56.6%)
There are superfluous steps	3 (3.3%)	25 (27.7%)	2 (2.2%)	1 (1.1%)	0	2 (2.2%)	33 (36.6%)
Total	28 (30.8%)	31 (34.1%)	6 (6.6%)	1 (1.1%)	4 (4.4%)	20 (22%)	90 (100%)

Table 2: Students' responses to the Parallelogram Task

The issues in this task were investigated by interviews as well. Here is an episode from one of the interviews:

(I – interviewer; A – Aseel, a student: discussing the Parallelogram Task)

- 1 I: Among two students from your class, one proved only that each two opposite sides are parallel. The other student proved only that each two opposite sides are equal.
- 2 A: O.K.
- 3 I: Which answer is correct? Are both of them correct? Is one of them correct? Is any answer correct?
- 4 A: Both are wrong, because in the parallelogram each pair of opposite sides are parallel and equal.
- 5 I: So, which answer do you prefer?
- 6 A: The first in which the student proves that each pair of opposite sides are parallel.
- 7 I: Why?
- 8 A: We call it parallelogram, parallel, the word parallel must be.

Aseel does not understand the "mathematical agreement" that a definition has to be minimal and that there are often equivalent definitions. In this episode Aseel (4) shows that like another 57% of the students she thinks that "all steps are necessary". Her way

of expressing it indicates that she is confused between the set of all attributes a parallelogram has, and a minimal set of attributes sufficient for the definition of a parallelogram. She does not attend to or does not understand the concept of economical definition and hence not the concept of economical proof either. In addition, the attribute ‘parallel’, which is part of the figure's name affects Aseel's definitions and therefore affects her preference for proving.

**Rectangle Or Not Task:** This task (See Figure 3) had three subtasks, but here we will relate to subtask b only. Our aim here is to investigate if and in what way understanding (or not) the inclusion relationships between groups of quadrilaterals is expressed in proving. Especially we want to know whether the students will use the rectangle and kite definitions or not. In the analysis of the first questionnaire we found that only 7% correctly identified the square as a kite and about 17% identified the square as a rectangle.

	<p>Definition: A rectangle is a parallelogram with one right angle.</p> <p>Problem: There is a circle with center O, <math>OB=OC</math> are two radii. They are <i>perpendicular</i>. From point A outside the circle we draw two tangents to the circle: AB and AC.</p> <p>Is <math>ABOC</math> a rectangle? If not which quadrilateral it is? Prove your answer!</p> <p>Mohamed says: <b><i>In the quadrilateral ABOC there are three right angles. In addition <math>OB=OC</math> (the radii are equal), therefore all 4 sides are equal. Hence the quadrilateral ABOC is a square and can't be a rectangle or a kite, because in a rectangle and a kite not all sides are equal.</i></b></p> <p>Is Mohamed's proof correct? If not, explain your response!</p>
--	--

Figure 3: Rectangle or not Task.

The main findings from Table 3 are: Only a third of the students claimed that Mohamed's proof was wrong. But only 27% of these use a correct definition of a kite or a rectangle, or correctly identified the inclusion relationships between the squares and rectangles and between the squares and kites; e.g. c10 writes: *because all 4 sides are equal and all angles are right angles and the square is a kite and also a rectangle*. About half of the students claimed that Mohamed's proof is correct and did not relate to the fact that the square has all the critical attributes of the rectangle and kite concepts. Whereas 57% among them didn't explain their responses (they were not asked to do it) and about 30% among them referred only to the square. E.g. c8 writes: *"right, according to what he proved the constructed shape is a square and not rectangle because he proved that there are 4 equal sides and 4 right angles"*. Again we have evidence that the difficulties in understanding the inclusion relationships among the groups of quadrilaterals and their attributes influence the ways the students deal with and evaluate proofs.



Student's claim \ Explanation	Didn't explain	Correctly used definitions of kite and rectangle	Correctly used the inclusion relationships	Claimed that Mohamed should prove that the other two sides are equal	Claimed that the square is a kite and not a rectangle	Only claimed that the shape is a square	Wrote unrelated things	Total
Didn't decide	8 (8.9%)	0	0	2 (2.2%)	0	0	0	10 (11.1%)
Mohamed's proof is correct	25 (27.7%)	0	1 (1.1%)	0	0	13 (14.4%)	5 (5.5%)	44 (48.9%)
Mohamed's proof is incorrect	1 (1.1%)	4 (4.4%)	4 (4.4%)	8 (8.9%)	2 (2.2%)	4 (4.4%)	7 (7.7%)	30 (33.3%)
Mohamed's proof is partially correct	0	0	1 (1.1%)	1 (1.1%)	0	4 (4.4%)	0	6 (6.6%)
Total	34 (37.7%)	4 (4.4%)	6 (6.6%)	11 (12.2%)	2 (2.2%)	21 (23.3%)	12 (13.3%)	90 (100%)

Table 3: Students' responses to the Rectangle or not Task

### CONCLUDING REMARKS

We can see a general and clear tendency: Student's difficulties in understanding the definitions of geometrical concepts affect these students' proof processes. These difficulties affect proof processes wherever these processes rely on the definitions. This tendency is in agreement with Knapp (2006). We can interpret some of these difficulties by the lack of students' understanding that a definition must on one hand not contain any superfluous information (see the Parallelogram Task), but must on the other hand contain a necessary and sufficient set of attributes. The other difficulties might be explained by the students' lack of understanding the two directions of inclusion relationships (see the third task): inclusion relationships between groups of quadrilaterals in one direction and the inclusion relationships of their attributes in the opposite direction (Hershkowitz et al., 1990). It is worth to note that in spite of what we claimed above, there are cases in which students are not attentive to incomplete proof although the correct definition is given as in the findings of the Trapezium Task.

### References

- Edwards, B. S., & Ward, M. B. (2004). Surprises from mathematics education research: Student (mis)use of mathematical definitions. *The American Mathematical Monthly*, 111, 411-424.
- Fischbein, E., & Kedem, I. (1982). Proof and certitude in the development of mathematical thinking. In A. Vermandel (Ed.), *Proc. 6<sup>th</sup> Conf. of the Int. Group for the Psychology of Mathematics Education* (pp. 128-131). Antwerp, Belgium: PME.

- Haj-Yahya, A., & Hershkowitz, R. (2013). When visual and verbal representations meet the case of geometrical figures. In A. M. Lindmeier & A. Heinze (Eds.), *Proc. 37<sup>th</sup> Conf. of the Int. Group for the Psychology of Mathematics Education* (Vol. 2, pp. 409-416). Kiel, Germany: PME.
- Hershkowitz, R. (1989). Visualization in geometry—Two sides of the coin. *Focus on Learning Problems in Mathematics*, 11, 61-76.
- Hershkowitz, R., Ben-Chaim, D., Hoyles, C., Lappan, G., Mitchelmore, M., & Vinner, S. (1990). Psychological aspects of learning geometry. In P. Nesher & J. Kilpatrick (Eds.), *Mathematics and cognition* (pp. 70-95). Cambridge: Cambridge University Press.
- Knapp, J. (2006). A framework to examine definitions in proof. In S. Alatorre, J. L. Cortina, M. Sais, & A. Mendez (Eds.), *Proc. of the 28<sup>th</sup> annual meeting of the North American chapter of the International Group for the Psychology of Mathematics Education* (Vol. 2, pp. 15-22). Merida, Mexico: PMENA.
- Martin, T. S., McCrone, S. M. S., Bower, M. L. W., & Dindyal, J. (2005). The interplay of teacher and student actions in the teaching and learning of geometric proof. *Educational Studies in Mathematics*, 60, 95-124.
- Moore, R. C. (1994). Making the transition to formal proof. *Educational Studies in Mathematics*, 27, 249-266.

# **GENDER-NEUTRAL, YET GENDERED: EXPLORING THE CANADIAN GENERAL PUBLIC'S VIEWS OF MATHEMATICS**

Jennifer Hall

University of Calgary

*By investigating the general public's views, we can better understand the cultural milieu in which mathematics teaching and learning take place. This study, part of an international research project, investigated the Canadian general public's views of gender and mathematics. Using a brief survey, people on the street and in public spaces in four demographically diverse locations in the Canadian province of Ontario were asked their views on the topic. The findings suggest reasons to be both cautiously optimistic and concerned. While the most common response to the questions examined was to see no gender difference, more participants held a gendered view (typically privileging boys) than a gender-neutral view.*

## **INTRODUCTION**

Investigating the general public's views about mathematics is essential in order to garner an understanding of the social milieu in which mathematics teaching and learning occur. Unfortunately, as argued by Leder and Forgasz (2010), "attempts to measure directly the general public's views about mathematics, its teaching and its impact on careers are rare" (p. 329). While several studies exist regarding views of mathematics, these studies are often conducted with select populations, such as high school and university students (e.g., Mendick, Epstein, & Moreau, 2007; Morge, 2006). Only a few known studies have investigated this topic with the general public, and none of these were in a Canadian context. For example, research in the United Kingdom explored the general public's images and opinions of mathematics (Lim, 1999; Lim & Ernest, 1999). Overall, the most negative views of mathematics were found in the youngest age group (17-20 years of age) and in students who were not mathematics majors. Views of mathematics were mixed: Encouragingly, the majority of participants disagreed with the stereotype that mathematics is a male domain. However, the majority of the participants also agreed that mathematics is a difficult subject, only for a select few. Lim concluded that the adults' views were primarily influenced by their school mathematics experiences. More recent research (Lucas & Fugitt, 2009), conducted in the United States, explored the general public's views of mathematics education. The study's participants tended to hold traditional views, criticizing today's practices as lacking emphasis on 'the basics' and being too focused on technology. Overall, mathematics was seen by the participants as being very important to success in both postsecondary education and future careers.

Due to concerns about a lack of research in this domain, Leder and Forgasz initiated research in Australia that investigated the general public's views of mathematics, with

a particular focus on gender and mathematics (reported in such publications as Forgasz & Leder, 2011; Forgasz, Leder, & Gómez-Chacón, 2012; and Leder & Forgasz, 2010, 2011). Using a brief survey, initially conducted on the street and later via Facebook, Leder and Forgasz gathered data from both Australian and international participants. In order to expand the research internationally, a team of researchers was assembled to collect street-level data in a variety of countries. The research reported in this paper addresses the data collected in Canada for this larger, international research project.

### **Context**

The data collection for the Canadian sample took place in the province of Ontario, which is located in central Canada and contains nearly 40% of the country's population (Statistics Canada, 2010a). In Canada, education falls under the purview of individual provinces and territories (i.e., no national curriculum exists). Ontario's mathematics curriculum (Ontario Ministry of Education, 2005a, 2005b, 2007) addresses a wide variety of mathematical topics in each grade level, and emphasis is placed on diversity in both teaching practices and assessment types. The use of mathematical tools is encouraged, both in class and on provincial large-scale assessments. Fundamentally, the Ontario Mathematics Curriculum is based on the belief that "all students can learn mathematics and deserve the opportunity to do so" (2005a, p. 3).

Since the 2003/2004 school year, Ontario students have been required to participate in large-scale provincial assessments of mathematics in Grades 3, 6, and 9. These assessments are created and conducted by the Education Quality and Accountability Office (EQAO). The EQAO assessments involve a variety of question types and address the provincial curriculum. My analysis of five years of EQAO data (Hall, 2012) showed that no statistically significant gender differences existed at any grade level in terms of mathematics achievement. In contrast, as demonstrated by data from the questionnaires that accompany the assessments, gender differences existed with regard to affective factors. Namely, across all grade levels and across the five years of data examined, a statistically significantly higher percentage of boys, compared to girls, reported liking mathematics and being good at it.

In Ontario, students are required to take three mathematics credits during high school. At the Grade 12 level, when most students have completed their required mathematics courses, boys have a higher proportion of mathematics courses in their timetables than do girls. Additionally, boys are the majority of students in five of the six Grade 12 mathematics courses offered (Hall, 2012). These gender differences persist at the university level, where women are the minority in mathematical fields from the bachelor's to doctoral degree level. Notably, the proportion of women in mathematical fields of study at the bachelor's and master's degree levels has been declining since the early 1990s (Statistics Canada, 2010b).

## **THEORETICAL FRAMEWORK**

This study was guided by a social constructivist and feminist epistemological stance, in which gender is viewed as being socially constructed, as well as historically and culturally situated. I align with Howard and Hollander's (1997) definition of gender as "the culturally determined behaviors and personality characteristics that are associated with, but not determined by, biological sex" (p. 11, as cited in Glasser & Smith, 2008, p. 346). In this definition, the roles that the broader society and culture play in policing behaviours presumed to be 'gender-appropriate' are highlighted, which is particularly relevant in mathematics, a field historically viewed as a male domain. I view both gender and sex as social constructions that fall on a spectrum, rather than into binary categories. That said, I support the lead researchers' decision to offer 'boys' and 'girls' as responses – both in terms of a pragmatic decision and in terms of reflecting current society, in which binaried representations and categorizations are the norm.

## **METHODOLOGY**

As this research is part of a larger, international project instigated by Gilah Leder and Helen Forgasz of Australia, the data collection instrument and methods of data collection followed the guidance of the principal investigators.

### **Data Collection Instrument**

Data were collected using a survey comprised of 14 questions that addressed the research topic (i.e., views of gender and mathematics) and the participant's mathematical experiences. Namely, two questions addressed the participant's school mathematics experiences, while the other 12 questions addressed the research topic. Specifically, three of these questions generally sought the participant's views on mathematics while nine addressed gender issues, both with regard to mathematics and science/technology more generally. In addition to these survey questions, demographic information about the participant's gender, age (under 20, 20 to 39, 40 to 59, and 60 and older), and home language (strictly English or another language) was collected.

### **Data Collection and Participants**

Data were collected in the Canadian province of Ontario between December of 2012 and August of 2013. Four locations were selected based on their varied demographic make-up, herein referred to as Rochester (rural, southwestern Ontario, population of 3,000), Thomasville (town, central Ontario, population of 25,000), Upton (urban, eastern Ontario, population of 900,000), and Smithburg (suburb, eastern Ontario, population of 110,000). Data collection took place in grocery stores in Rochester and Smithburg, in a community centre in Thomasville, and on a downtown street in Upton. In each location, permission to conduct the research was garnered by the appropriate individuals (e.g., store managers), in addition to the Research Ethics Board permission granted by the Australian and Canadian universities associated with the research. In Thomasville, the initial data collection site, I collected the data by myself, which resulted in an inefficient process (seven hours to collect approximately 50 surveys).

For the other three sites, I was assisted by a colleague in order to make the data collection process more efficient; in each instance, the requisite number of surveys was collected in two hours. In each location, data collection occurred on a weekend day or holiday, in hopes of maximizing the number of passersby.

In each instance, I would approach a passerby, introduce myself, and ask if they would be willing to take part in a brief survey. Participants were then asked if they agreed to be audiotaped; if not, answers were recorded on a hard copy of the survey. Prior to being asked the gender-related questions, the participants were informed that, although the questions were worded in a binary manner (i.e., girls or boys), they were welcome to answer as they wished (e.g., ‘They are equal’). If participants inquired further about the research project, a handout was provided with more information.

In total, 204 people participated in this project: 52 from Rochester, 53 from Thomasville, 49 from Upton, and 50 from Smithburg. In each location, more women than men took part, although the participants were more gender-balanced in Upton and Smithburg (55.1% and 52.0% women, respectively) than in Rochester and Thomasville (67.3% and 62.3% women, respectively). Overall, 59.3% of the participants were women. The age distribution of the participants is shown in Table 1, with percentages applying to each row.

	Age Category			
	Under 20	20 to 39	40 to 59	60 and older
Rochester	4 7.7%	15 28.8%	13 25.0%	20 38.5%
Thomasville	0 0.0%	26 49.1%	11 20.8%	16 30.2%
Upton	0 0.0%	33 67.3%	9 18.4%	7 14.3%
Smithburg	0 0.0%	13 26.0%	20 18.4%	17 34.0%
Total	4 2.0%	87 42.6%	53 26.0%	60 29.4%

Table 1: Participants, by age category

### Data Analysis

Using the audio or written recordings, the participants’ responses to the questions were coded using categories (e.g., ‘boys’, ‘girls’, ‘same’, ‘don’t know’, ‘depends’) provided by the lead researchers (to allow for international comparisons). These data were analyzed using descriptive statistics (e.g., percentages). If participants provided further explanation for their responses, these comments were transcribed and analyzed using emergent coding. That is, the responses for each question were examined to obtain a sense of the data, and then categories were created and used to code the responses. Due to the space constraints of this paper, results will be presented for the dataset as a

whole. During the conference, additional analysis with regard to the age and gender of the participants will be presented.

## **FINDINGS**

For the purposes of this paper, I focus on the two questions about the participants' school experiences, in order to provide a clearer profile of those who took part in the research, and the five questions that specifically related to gender and mathematics. Findings are presented for each question in the following sections. Responses that were coded as 'don't know' or 'depends' are combined as 'unsure/ambivalent'.

### **When you were at school, did you like learning mathematics?**

Just over half of the participants (54.4%) reported that they enjoyed learning mathematics while they were in school, compared to 33.3% who reported disliking mathematics. Only 12.3% of the respondents reported feeling ambivalent toward mathematics. Unsurprisingly, the explanations provided for positive or negative feelings toward mathematics often related to how strong or weak the participants felt they were in mathematics. Other reasons provided for liking mathematics included finding the subject interesting and real-world applicable, as well as appreciating the logic, order, and 'black and white' nature (i.e., only one right answer) of mathematics. Participants who disliked mathematics described it as boring, reported having poor teachers, and described themselves as 'language people'.

### **Were you good at mathematics?**

As noted, reports of liking mathematics were often linked to reports of being good at mathematics. It follows that a similar proportion of participants, 52.9%, reported being good at mathematics. However, participants who felt they were not good or average at mathematics were more evenly distributed (27.0% and 20.1%, respectively) than the 'no' or 'ambivalent' responses to the prior question. Explanations for being good at mathematics primarily related to school grades, although a few participants provided other evidence, such as working in a mathematics-focused field, being in gifted classes, and understanding mathematics quickly.

### **Who are better at mathematics, girls or boys?**

Encouragingly, the most common response (37.3%) was that there were no gender differences. However, this response was only slightly more common than believing that boys are better at mathematics (31.9%). Although a substantial proportion of participants reported that girls are better at mathematics (20.6%), these responses were only two-thirds the number of those who selected boys. Therefore, over half of the participants held some sort of gendered stance with regard to mathematics. Few participants reported being unsure or ambivalent toward this question (10.3%). Explanations for girls' mathematical superiority often related to girls being stronger students overall, whereas explanations for boys' mathematical superiority tended to relate to innate ability ('mathematical nature'). Related, the notion of girls being better at language arts and boys being better at mathematics was discussed.

### **Do you think this has changed over time?**

Participants' views were quite mixed (40.2% agreed and 44.6% disagreed), which may perhaps be indicative of different interpretations of the question. Some participants' explanations appeared to indicate that they thought the question referred to ability, whereas others' explanations indicated understanding the question as referring to achievement. In the former cases, participants would explain that girls and boys have always been equally capable of doing mathematics, but that societal factors may have held girls back (e.g., sexist teachers). In the latter cases, participants stated that boys used to do better at mathematics, but that girls now do equally as well (or, in some cases, better), since they have more opportunities. Nearly one-sixth (15.2%) of the participants reported being unsure or ambivalent about this question.

### **Who do parents believe are better at mathematics, girls or boys?**

While the participants' views of parents' views of gender and mathematics were quite mixed, the most common response was to believe that parents thought that boys were better than girls at mathematics (30.9%). These participants argued that parents held these views because they believed the stereotypes about gender and mathematics. Nearly as many participants (27.9%) argued that parents held gender-neutral views of their children and mathematics. As with the previous question, the least common view was that parents believed that girls were better at mathematics (21.1%). Similar to the previous question, one-fifth of the participants reported being unsure or ambivalent about this question (20.1%). These participants often explained that they either did not have children or that their children were adults.

### **Who do teachers believe are better at mathematics, girls or boys?**

In contrast to views of parents, the most common view of teachers was that they held gender-neutral views of their students and mathematics (33.8%). Participants explained that teachers would have more knowledge about this topic than the 'average person', plus they would have exposure to many children doing mathematics, so would form a less biased view than parents (who may base their opinions solely on their own children). Perceptions of teachers holding gendered views were fairly equally distributed: 18.6% of participants reported boys, compared to 20.1% reporting girls. Explanations provided were similar to those discussed with regard to being better at mathematics in general. A large proportion of the participants (27.5%) reported being unsure about teachers' feelings. These participants typically explained that they had no contact with teachers at the present time, either because they did not have school-aged children or because they did not know any teachers personally.

### **Is it more important for girls or boys to study mathematics?**

Of all the questions regarding gender and mathematics, this question had the most consistency in the participants' responses: 94.6% of the participants argued that it was equally important for boys and girls to study mathematics. Only 2.5% of participants reported a gendered stance (0.5% for girls; 2.0% for boys). Additionally, only 3.0%



reported being unsure or ambivalent toward this question. The overwhelmingly most common explanation provided was that everyone needs to know mathematics – for school, everyday life, and future occupations. Indeed, many participants were incredulous that the survey would even include such a question.

## CONCLUDING REMARKS

The data from over 200 participants from the Canadian province of Ontario suggest that gendered views of mathematics (and of others' views of mathematics) tend to be the norm. Although 'no difference' was typically the category with the highest proportion of responses, the combination of 'girls' and 'boys' categories (i.e., the gendered responses) was almost always a higher proportion. The only question for which the majority of participants held a gender-neutral view (rather than a 'boys' or 'girls' view) addressed studying mathematics. For the questions regarding superiority in mathematics, more participants held a gendered view (either boys or girls) than a gender neutral view. In most cases involving gendered views, more participants selected boys than girls, indicating a more favourable view of boys and mathematics. This finding suggests that gender stereotypes regarding mathematics persist, even in a very gender-neutral society like Ontario, wherein equity is inscribed in the mathematics curriculum. Similar findings were found in the culturally-similar country of Australia: While nearly all participants held gender-neutral views with regard to studying mathematics and 'no difference' tended to be the most common response, the greatest proportion of participants held gendered views regarding being 'better' at mathematics, with boys being selected more often than girls as a response (Leder & Forgasz, 2010).

The findings from this Canadian research, while somewhat encouraging, should also raise concerns for those involved in mathematics education. Since the majority of the adults surveyed tended to hold gendered views (with more of these gendered views favourable toward boys than girls), these messages are arguably being disseminated to young people, particularly by their parents. In another research project (Hall, 2013), I found that children's views of mathematics are indeed impacted by their parents' views of the subject matter. Thus, targeting parents' understandings of gender and mathematics, by both the educational system and the media (which, in both cases, mathematics education researchers can play a key role), should be a focus.

## References

- Forgasz, H. J., & Leder, G. C. (2011). Mathematics, computers in mathematics, and gender: Public perceptions in context. *PNA*, 6(1), 29-39. Retrieved from <http://www.pna.es/index2Eng.html>
- Forgasz, H., Leder, G., & Gómez-Chacón, I. M. (2012). Young pedestrians' gendering of mathematics: Australia and Spain. In J. Dindyal, L. P. Cheng, & S. F. Ng (Eds.), *Mathematics education: Expanding horizons: Proc. 35<sup>th</sup> annual conf. of the Mathematics Education Research Group of Australasia* (pp. 298-305). Singapore: MERGA.

- Glasser, H. M., & Smith, J. P. III (2008). On the vague meaning of “gender” in education research: The problem, its sources, and recommendations for practice. *Educational Researcher*, 37(6), 343-350. doi:10.3102/0013189x08323718
- Hall, J. (2012). Gender issues in mathematics: An Ontario perspective. *Journal of Teaching and Learning*, 8(1), 59-72.
- Hall, J. (2013). *Societal views of mathematics and mathematicians and their influence on elementary students* (Unpublished doctoral dissertation). University of Ottawa, Ottawa, Ontario, Canada.
- Leder, G. C., & Forgasz, H. J. (2010). I liked it till Pythagoras: The public’s views of mathematics. In L. Sparrow, B. Kissane, & C. Hurst (Eds.), *Shaping the future of mathematics education: Proc. 33<sup>rd</sup> annual conf. of the Mathematics Education Research Group of Australia* (pp. 328-335). Fremantle, Australia: MERGA.
- Leder, G. C., & Forgasz, H. J. (2011). The public’s views on gender and the learning of mathematics: Does age matter? In J. Clark, B. Kissane, J. Mousley, T. Spencer, & S. Thornton (Eds.), *Mathematics: Traditions and new practices: Proceedings of the AAMT-MERGA conference* (pp. 446-454). Adelaide, Australia: MERGA.
- Lim, C. S. (1999). Using metaphor analysis to explore adults’ images of mathematics. *Philosophy of Mathematics Education Journal*, 12, Article 9. Retrieved from <http://people.exeter.ac.uk/PErnest/pome12/article9.htm>
- Lim, C. S., & Ernest, P. (1999). Public images of mathematics. *Philosophy of Mathematics Education Journal*, 11, Article 6. Retrieved from <http://people.exeter.ac.uk/PErnest/pome11/art6.htm>
- Mendick, H., Epstein, D., & Moreau, M.-P. (2007). *Mathematical images and identities: Education, entertainment, social justice*. Swindon, England: Economic and Social Research Council.
- Morge, S. P. (2006). *College students’ beliefs about mathematics, gender, and popular media* (Unpublished doctoral dissertation). University of Indiana, Bloomington, IN.
- Ontario Ministry of Education. (2005a). *The Ontario curriculum grades 1-8: Mathematics (Revised)*. Toronto, Ontario, Canada: Queen’s Printer for Ontario.
- Ontario Ministry of Education. (2005b). *The Ontario curriculum grades 9 and 10: Mathematics (Revised)*. Toronto, Ontario, Canada: Queen’s Printer for Ontario.
- Ontario Ministry of Education. (2007). *The Ontario curriculum grades 11 and 12: Mathematics (Revised)*. Toronto, Ontario, Canada: Queen’s Printer for Ontario.
- Statistics Canada. (2010a). *Table 051-001 – Estimates of population, by age group and sex for July 1, Canada, provinces and territories, annual (persons unless otherwise noted), CANSIM (database), Using E-STAT (distributor)*. Retrieved July 1, 2010, from <http://estat.statcan.gc.ca/>
- Statistics Canada. (2010b). *Table 477-0014 - University degrees, diplomas and certificates granted, by program level, Classification of Instructional Programs, Primary Grouping (CIP\_PG) and sex, annual (number), CANSIM (database), Using E-STAT (distributor)*. Retrieved June 28, 2010, from <http://estat.statcan.gc.ca/>

# WHAT AND HOW MATHEMATICS SHOULD BE TAUGHT: VIEWS OF SECONDARY MATHEMATICS TEACHER CANDIDATES WITH STEM BACKGROUNDS

Allyson Hallman-Thrasher, Jeff Connor

Ohio University

*This qualitative study examines what mathematics teacher candidates with STEM backgrounds think about their future work as mathematics teachers. The content preparation for a STEM career is not identical with that taken by traditional teacher candidates and may not develop the pedagogical content knowledge necessary for candidates to connect their experience with the grade 7-12 classroom. Candidates were found to emphasize applied mathematics in both what, and how, with little attention given to mathematical proof. Given their interest applications of mathematics, they, surprisingly, struggled to articulate how to meaningfully integrate science and mathematics.*

U.S. K-12 students' continue to struggle in mathematics and science achievement. Recent PISA results show that US is outperformed in mathematics by 35 of 65 participating countries (Organization for Economic Cooperation and Development, 2013). One remedy to weak student performance is to increase teacher quality and a route for improving teacher quality in mathematics and science that is gaining popularity is to recruit teachers with expertise in science, technology, engineering and/or mathematics (STEM) content areas (e. g., Robert Noyce Teacher Scholarship Program, Woodrow Wilson Teaching Fellows program, Knowles Science Teaching Fellows program). The assumption underlying these programs is that individuals with strong STEM content backgrounds can be transformed into effective mathematics and science teachers in a shorter time frame than can traditionally prepared teacher candidates, and with minimal attention to content knowledge. The study reported here examines what mathematics teacher candidates with STEM backgrounds think about their future work as grade 7-12 mathematics teachers and their preparation for that work in a program with STEM discipline integration. We define STEM background as having an undergraduate degree in a STEM field or, in addition to a degree, having work experience as a STEM professional. This study is part of a larger research project whose goal is to determine how the content backgrounds and prior experiences of STEM graduates and STEM professionals influence their teaching.

## OUR STEM TEACHER EDUCATION PROGRAM

Ohio University hosts a one-year master's program that prepares candidates with STEM backgrounds for certification in grades 4-9 or 7-12 mathematics or science teaching. The first cohort began the program in summer 2012, the second in summer 2013, and the final cohort in summer 2014. Each cohort completes the program one

calendar year after beginning. Teacher candidates start the first summer semester with coursework focused on curriculum, learning, development, and making connections between STEM disciplines and grade 4-12 mathematics and science classrooms. A unique feature of the program in the first semester is that candidates seeking mathematics licensure or science licensure take courses together that focus on all STEM content areas. During fall semester, the candidates continue taking general education courses together, but also have content and content-specific teaching methods courses that are only for mathematics teacher candidates or science teacher candidates. They also work with a mentor teacher three days a week in a grade 4-9 or grade 7-12 mathematics or science classroom. In spring, they complete their professional internship (student teaching) under the supervision of the same mentor teachers. In their final summer semester, they complete and present their masters research thesis.

### **CHALLENGES FACING TEACHER PREPARATION FOR STEM EXPERTS**

Programs such as ours are not a panacea for the nation's struggling students and schools. Programs that prepare teacher candidates with STEM backgrounds face challenges that are distinct from or more pervasive than those of a traditional teacher preparation program. Developing thorough content knowledge is often a key aim of mathematics teacher preparation programs. In programs for content experts this goal is often assumed to be met by candidates' prior experience and this assumption can be problematic for several reasons. First, content preparation of a mathematics or science major is not identical to that of K-12 mathematics teacher. The coursework taken to prepare for a STEM career is likely different than the STEM coursework taken by prospective teacher (e.g., a typical engineering or mathematics major does not take coursework in geometry). Second, even with an ideal content background, content knowledge alone does not determine teacher effectiveness (Monk, 1994). Pedagogical knowledge has been shown to have an impact on mathematics teaching effectiveness as well (Brown & Borko, 1992), but teacher candidates who were trained as STEM professionals have less exposure to pedagogical issues than their traditionally prepared counterparts. They are unlikely to have familiarity with or experience in K-12 schools (beyond their own tenure as a K-12 student) that would have been developed in the early years of traditional undergraduate teacher education program through coursework and field experiences. A third potential challenge a teacher candidate who was trained as a STEM professional may face is connecting her or his STEM background and previous coursework to the K-12 curriculum. Pedagogical content knowledge is more specialized than disciplinary content knowledge and includes more than knowing and doing mathematics well; it must also involve representing content in multiple ways, making challenging content accessible to students, and guiding students to a broad conceptual understanding of mathematics (Shulman, 1986). Teacher candidates with STEM backgrounds will have views of mathematics and science that are based on their prior STEM studies and experiences and that may not be conducive to the development of pedagogical content knowledge.

## **BACKGROUND**

There is a small but growing body of literature related to STEM major and STEM career changer teacher preparation programs, but there is nearly no literature addressing how the content backgrounds and prior experiences of STEM graduates and STEM career changers influence their teaching. One exception is Vierra's (2011) work addressing the question of how a non-teaching STEM background influences the development of the content knowledge for teaching. In her study of 69 teacher candidates from multiple universities, she compared the entry-level pedagogical content knowledge of first year mathematics teachers with STEM career backgrounds to first year teachers with traditional backgrounds. Vierra found that there was no consistency in the pedagogical content knowledge in either STEM career changes or traditionally prepared teachers and no significant difference between these two groups. She concluded pedagogical content knowledge was not predictable based on a candidate's background.

More generally, the connection between knowledge of mathematics content and teaching effectiveness at the secondary level is poorly understood. Though content knowledge is an essential component of what makes an effective teacher (National Mathematics Advisory Panel, 2008), there is less evidence for a strong connection between teacher effectiveness and content knowledge in the absence of pedagogical knowledges (Goos, 2013). There is, however, a connection between mathematics teacher effectiveness and a teacher's pedagogical or specialized content knowledge (Ball, Thames, & Phelps, 2008), which is related to content knowledge. This literature suggests that a candidate's STEM background, in and of itself, will not guarantee their becoming an effective teacher; the formation of their pedagogical content knowledge (i.e., how they will use their knowledge in the classroom) will be critical to their success. As the teacher candidates are to build on their STEM backgrounds whilst becoming teachers, how their STEM background might influence their development of pedagogical content knowledge, and hence their development as effective teachers, is a nontrivial gap in the literature—especially in light of society's substantial investment in preparing STEM professionals to become teachers.

This study examined the views of mathematics teacher candidates with STEM backgrounds in regards to teaching and their teacher preparation in a program with integration among STEM disciplines. An implicit assumption of policies promoting the recruitment of STEM professionals into teaching is that the benefits of a STEM background are wholly positive. However, there exists the possibility that a STEM background may lead to misconceptions about teaching, learning, or the articulation of mathematics curricula. It is important to be aware of such issues so that teacher preparation programs can respond by tailoring experiences for this population. By examining this particular subset of teacher candidates' views on teaching at the outset of their preparation program, our study is a first step towards reaching this goal.

## METHODS

In the larger study, the candidates are interviewed three times: immediately after the first summer term, at the conclusion of their professional internship, and at the end of their first year of teaching. The data reported in this paper is focused on the first interview, in which candidates were asked about the impact of their preparation for a career as a STEM professional and/or work experience in STEM fields on their preparation for careers as teachers. Admission to the program was selective: candidates were accepted based on strong content backgrounds and demonstrated potential for teaching. In the first cohort of 12, five sought initial licensure in grades 7-12 mathematics. All of those candidates had earned their bachelor's degree no more than five years before entering the program and two had prior work experience in a STEM field. Degree areas included chemistry, accounting, and mathematics (pure and applied) and biology. All five mathematics candidates participated in this study.

Interviews ranged in length from approximately 40 to 70 minutes. The interviewer used the questions listed in Figure 1 to guide these interviews and, as needed, used follow-up probes to help the candidate elaborate on or clarify an idea. The five interview transcripts comprised the data set for this study.

<p>How did you become interested in (math, biology, chemistry and/or physics)?</p> <p>Could you describe your school experiences (K-college) related to the study of (math, biology, chemistry and/or physics)?</p> <p>Could you describe your work experiences related to the study of (math, biology, chemistry and/or physics)?</p> <p>How do you think your school experiences (K-college) related to the study of (math, biology, chemistry and/or physics) will affect the content you will teach?</p> <p>How do you think your school experiences related to the study of (math, biology, chemistry and/or physics) will affect the teaching methods you will use?</p> <p>How do you think your work experiences related to the study of (math, biology, chemistry and/or physics) will affect the content you will teach?</p> <p>How do you think your work experiences related to the study of (math, biology, chemistry and/or physics) will affect the teaching methods you will use?</p> <p>How do you think experiences outside of school or work will affect the teaching methods you will use?</p>
---

Figure 1: Interview questions

To analyze data, researchers read and coded transcripts using an open coding process (Denzin & Lincoln, 2000) where researchers individually developed descriptive codes while reading the transcripts. At least three researchers read and coded each transcript with some team members reading all of the transcripts. The team noted which codes were common among all researchers and these became the basis for a composite

coding scheme. For codes that were not common to all team members, discussion led to consensus to either to omit the code because it was too idiosyncratic, add it because it provided greater clarity, or merge it with another code because it was duplicative. In a few cases, discussion of codes led researchers to subdivide one code into several, each providing greater specificity. For example, the team divided the code *teacher influence*, a code common to all members, into three more specific codes: *influence from family member who was a teacher*, *influence from K-12 teacher*, and *influence from post-secondary teacher*.

With the coding scheme established, one coded transcript was compiled for each of the five candidates and researchers identified emergent themes. Then, each researcher returned to the transcripts to look for evidence of the salience of the emergent themes that had been suggested, identify alternative themes, and develop ideas about how to map back from the set of emergent themes to evidence in the data set. For each emergent theme, a summary was composed that included a description and the data supporting that theme.

This data analysis method contributed to the credibility of the findings not only through its careful attention to the data and its systematic approach to analysis but also through its reliance on investigator triangulation (Denzin, 1978). Because there were multiple readers of the transcripts, it was less likely for the preconceptions of one researcher to influence the ultimate interpretation. In the few cases where members of the team had different initial readings of the data or different perspectives about the salience of a potential theme, review of portions of the transcripts helped the group as a whole reach consensus. The eventual list of themes therefore represented the best judgment of the research team as a whole.

## RESULTS

In framing our findings, we rely on two roughly synonymous constructs from mathematics and science education, respectively: teacher beliefs (Phillip, 2007) and teacher orientation (Friedrichsen, Driel, & Abell, 2011). The orientation scheme considers three categories of teacher conceptions: about the nature of the science, about the nature of science teaching and learning, and about the goals of science education. Beliefs in mathematics education are not as neatly divided, but several primary areas of research on beliefs parallel the structure of science education's orientation scheme: beliefs about mathematics (conceptions of discipline), beliefs about students' mathematical thinking, beliefs about curriculum, and beliefs about technology (conceptions of teaching). Following Pajaraes (1992), who warns that merely examining beliefs as a whole is unhelpful, we focus on particular "belief[s]-about". The themes presented here are organized by orientations/beliefs about: 1) *what* content should be taught, (candidates' understanding of mathematics) and 2) *how* the content should be taught, (what is good mathematics teaching).

### **What content should be taught**

The mathematics candidates had a narrow view of mathematics. They all described mathematics as a tool for problem solving, and mentioned that problem solving was what they found most engaging about studying mathematics. In discussing the mathematics they would emphasize in their own teaching, they focused on applied mathematics or topics generally useful for other STEM disciplines. They often valued mathematics for its usefulness as a tool for other disciplines. They also discussed the difference between applied and pure or theoretical math, with all but Alex (whose STEM training was in pure mathematics) noting a preference for the former. One candidate summarized this view saying, “I like having a practical problem that I can actually solve, and having real world applications” (Reagan, p. 4). Another candidate noted that she valued using “more real world applicable” ideas in K-12 mathematics classes (Jennie, p.10). Four out of five of the mathematics candidates expressed some degree of dissatisfaction with mathematical proof; in particular they did not appreciate why proof was needed. Reagan tried to articulate the group’s reaction to proving:

The proofs in geometry seem illogical to me. Or unnecessary....I felt like a lot of the geometry proofs that I did [in her summer courses] were like, ‘Well, this is pretty clear. I don’t know why I’m doing a proof. It just makes sense.’ (p. 22)

At the same time, the candidates noted that in their own study of mathematics they “couldn’t much memorize things. I had to actually know how it works” (Gerald, p. 5) and that they enjoyed explaining math to others.

Though mathematics candidates valued applied over theoretical mathematics and viewed mathematics as a tool needed for science, they were challenged by the idea of integrating the STEM disciplines. On the surface candidates claimed that using applications of mathematics “gives a purpose for what you’re learning [in mathematics class]” (Jennie, p. 13) and they acknowledged that the STEM disciplines “all just hook together in a way” (Sienna, p. 8). They were even able to mention one example of a way relate two STEM fields, though with varying specificity. Reagan, Alex, and Gerald explicitly noted using mathematics to model scientific phenomena (e.g., modeling population growth, carbon dating, and the molecular make-up of chemical compounds). All candidates spoke more generally of physics or physical science as natural or obvious way to connect science and mathematics. But when pressed to elaborate on these ideas, the candidates struggled: “I haven’t really figured out all of the ways it [the STEM disciplines] hooks together” (Sienna, p. 8). Though they found it interesting to learn about STEM topics outside of their discipline, most did not see integrating the topics as a way to drive teaching practice. A mathematics candidate explained her view on integrating STEM disciplines:

In some ways, some of the things we talked [in class] about don’t directly correlate to mathematics, and so it’s hard to see how I would correlate them into my mathematics classroom.... to use mathematics to discover things in scientific fields and things. I think that it’s great when the two of them can be combined as often as possible, but I think that there’s a point where they also need to be separated out. (Jennie, p. 11)



## How content should be taught

Mathematics candidates cited *relevance* as a motivator for learning content and considered that a key facet of instructional practice. They mentioned *relevance* in three contexts, which framed their thinking about becoming teachers: relevance as an aspect of their own K-12 and undergraduate experience; relevance of their STEM-integrated program coursework; and relevance as a desired feature of their own future pedagogy. Relevance also had two different meanings: relevance as what engages or interests students and relevance as what students need to know about a topic.

All candidates mentioned former teachers who “made everything fun and relatable” (Sienna, p.3), with three candidates specifically mentioning courses that were hands-on and/or project-based. Jennie elaborated, saying one of her favorite teachers:

would pull in things in that he knew would interest us, that also had Chemistry within them, and I think that that’s really important to, high school kids, because that’s how you keep their attention...that’s how you keep them interested in your subject area. (p. 14)

They believed these features spurred their own interest in mathematics and science and they wanted to replicate those experiences for their students. Alex extended the notion of relevance further, stating:

I think if you can help the kids understand, what kinds of jobs are out there...how these different jobs use math, use science, bring it together, I think it’ll help them really become interested in some of these things. (p. 7)

The candidates were less certain as to how relevance played out in their program courses. Some candidates appreciated STEM integration as with Alex who explained why he enjoyed a particular lesson: “It played to the science, it played to the math, and we could all see how we [the different content areas] were all together” (p. 6). Whereas other mathematics candidates found the integration unbalanced, and this, at times, led to isolation and doubt about the relevance of integration. Reagan stated, “I don’t know that that [a unit on the philosophy of science] was particularly helpful for a lot of us (p. 16). Candidates wanted instruction that was relevant for them and for their prospective students. All five stated that they would teach particular mathematics topics or concepts because, “They’re going to do this in their real life” (Sienna, p. 8).

## CONCLUSIONS

There were several surprising inconsistencies in the candidates’ views on what, and how, mathematics should be taught. Overwhelmingly, mathematics candidates wanted to recreate for their future students the experiences that had most engaged them as students: using mathematics as a tool for problem solving. While they valued understanding the *why* behind mathematical ideas, they did not see proof as a means of explaining mathematics. While candidates valued using applications of mathematics as a way to make mathematics interesting and relevant to students, they could not meaningfully address how to use the sciences to provide applications for mathematics content. This is especially noteworthy because these candidates were ideally

positioned to be aware of integrating STEM disciplines (having a strong STEM content background, being immersed in a setting of diverse STEM expertise, and taking coursework designed to motivate their attention to integrating STEM).

## References

- Ball, D., Thames, M. H., & Phelps, G. (2008). Content knowledge for teaching: What makes it special? *Journal of Teacher Education*, *59*, 389-407. doi:10.1177/0022487108324554
- Brown, C. A., & Borko, H. (1992). Becoming a mathematics teacher. In D. A. Grouws (Ed.), *Handbook of research on mathematics teaching and learning* (pp. 209-239). New York, NY: Macmillan.
- Denzin, N. K. (1978). *The research act: A theoretical introduction to sociological methods*. New York, NY: McGraw-Hill.
- Denzin, N. K., & Lincoln, Y. S. (2000). Introduction: The discipline and practice of qualitative research. In N. K. Denzin & Y. S. Lincoln (Eds.), *Handbook of qualitative research* (2nd ed., pp. 1-28). Thousand Oaks, CA: Sage.
- Friedrichsen, P., Driel, J. H. Van, & Abell, S. K. (2011). Taking a closer look at science teaching orientations. *Science Education*, *9*, 358-376. doi:10.1002/sce.20428
- Goos, M. (2013). Knowledge for teaching secondary school mathematics: What counts? *International Journal of Mathematical Education in Science and Technology*, *44*, 972-983. doi:10.1080/0020739X.2013.826387
- Monk, D. H. (1994). Subject area preparation of secondary mathematics and science teachers and student achievement. *Economics of Education Review*, *13*, 125-145. doi: 10.1016/0272-7757(94)90003-5
- National Mathematics Advisory Panel. (2008). *Foundations for success: The final report of the National Mathematics Advisory Panel*. Washington, DC: U.S. Department of Education.
- Organization for Economic Cooperation and Development. (2013). *PISA 2012 results in focus*. Retrieved from <http://www.oecd.org/pisa/keyfindings/pisa-2012-results-overview.pdf>
- Pajares, M. F. (1992). Teachers' beliefs and educational research: Cleaning up a messy construct. *Review of Educational Research*, *62*, 307-322. doi:10.3102/00346543062003307
- Philipp, R. A. (2007). Mathematics teachers' beliefs and affect. In F. K. Lester (Ed.), *Second handbook of research on mathematics teaching and learning* (pp. 257-315). Charlotte, NC: Information Age Publishing.
- Shulman, L. S. (1986). Those who understand: Knowledge growth in teaching. *Educational Researcher*, *15*(2), 4-14. doi: 10.3102/0013189X01500200
- Vierra, V. A. (2011). *A comparison study of the pedagogical content knowledge of single subject mathematics credential candidates* (Doctoral dissertation). Available from ProQuest Dissertations and Theses database. (UMI No. 3495767)

# TEACHING LINEAR ALGEBRA IN THE EMBODIED, SYMBOLIC AND FORMAL WORLDS OF MATHEMATICAL THINKING: IS THERE A PREFERRED ORDER?

John Hannah<sup>1</sup>, Sepideh Stewart<sup>2</sup>, Mike Thomas<sup>3</sup>

<sup>1</sup>Canterbury University, NZ, <sup>2</sup>Oklahoma University, USA, <sup>3</sup>Auckland University, NZ

*This research project involved teaching linear algebra to second year undergraduates. Using Tall's three worlds of mathematical thinking as a theoretical framework, students were taught fundamental linear algebra concepts using each of the embodied, symbolic and formal dimensions. By varying the order in which these approaches were used in each topic we investigated students' perceptions of the combinations and their potential for understanding and learning. The results show that students seem to react positively to symbolic examples and embodied ideas but there is little effect overall of order on understanding.*

## BACKGROUND

Can we improve the way we introduce students to linear algebra concepts? Over the last decade Tall's (2004, 2008, 2010) theory of three worlds of embodied, symbolic and formal mathematical thinking, along with APOS theory (Dubinsky & McDonald, 2001), has been employed to construct a Framework of Advanced Mathematical Thinking (FAMT) (Stewart & Thomas, 2009) for investigating lecturing (Hannah, Stewart, & Thomas, 2013) and students' conceptual understanding of key linear algebra concepts (e.g., Thomas & Stewart, 2011). According to Tall's theory, in the embodied world we think using our mental perceptions of real-world objects and other forms of visuo-spatial imagery (Tall, 2004). In this world a vector might be thought of as directed line segment, or a quantity having magnitude and direction. In the symbolic world we calculate using symbols, arrays and equations. In this world a vector might be an  $n$ -tuple of real numbers. In the formal world objects are defined in terms of their properties, with new properties deduced by formal proof. In this world a vector is an object obeying the axioms for elements of a vector space. All three worlds are available to, and used by, individuals as they engage with mathematical thinking, and they interact so that "three interrelated sequences of development blend together to build a full range of thinking" (Tall, 2008, p. 3). When students first meet new concepts, such as *subspace* or *linear independence*, the question naturally arises as to whether there is a right, or best, order in which they should meet these three world views of the concepts. Tall observes that although school students usually meet embodiment first, followed by symbolism and then, finally, formalism, "when all three possibilities are available at university level, the framework says nothing about the sequence in which teaching should occur" (Tall, 2010, p. 22). So a fundamental research question for us is whether there is a preferred order of presentation of concepts in the FAMT framework.

Traditionally, a typical first linear algebra course begins in the formal world, with an axiomatic presentation that took many years to achieve its present form (Harel & Tall, 1989). But the presentation could perhaps just as easily begin in the embodied or symbolic worlds. A number of recent studies have considered the relationship between formal thinking in linear algebra and students' other approaches and demonstrated that to develop teaching that promotes formal ideas a knowledge of student thinking prior to teaching is valuable. For example, Wawro, Sweeney, and Rabin (2011) considered students' concept images of the notion of subspace and found that they made use of geometric, algebraic and metaphoric ideas to make sense of the formal definition. In other work, Wawro, Zandieh, Sweeney, Larson, and Rasmussen (2011) found that students' intuitive ideas about span and linear independence could be employed to assist them to develop the formal definitions.

In this paper we present the results of a study where the lecturer (the second author) experimented with different orders of presentation for each of the main concepts in an introductory linear algebra course. A crucial feature of her lectures was the use of *contingent teaching* (Draper & Brown, 2004), which involves gaining responses from the whole class via clickers and immediately reacting to the data, so that the lecturer is constantly confronted with decision making. Research shows that although lecturers appreciate the feedback they receive through clickers (Abrahamson, 2006) the ability to react to these responses on the spot, according to students' needs, is challenging. In this setting "lecturers must develop their plans beyond the factory machine stage of executing a rigid, pre-planned sequence regardless of circumstances" (Draper & Brown, 2004, p. 91) and have relevant strategies on hand, depending on student responses.

## METHOD

This research project comprised a mixed methodology of action research, as a university lecturer examines and refines her teaching practice, along with a case study of student reactions to the teaching. The first phase of the project was conducted in the Fall of 2013 at a large research university in the USA. The researcher, who is the second named author, was teaching an introduction to linear algebra course to two classes of students (mainly from engineering and other science majors), C1 and C2.

To investigate whether the order in which the material is presented has an impact on students' learning and attitudes, each of the following possible combinations of teaching concepts was used: Embodied, Symbolic, Formal (ESF); Embodied, Formal, Symbolic (EFS); Symbolic, Embodied, Formal (SEF); Symbolic, Formal, Embodied (SFE); Formal, Symbolic, Embodied (FSE); Formal, Embodied, Symbolic (FES) and two most common ways of teaching with no embodied exposure at all: Formal, Symbolic (FS) and Symbolic, Formal (SF). The aim was to try to establish whether the order influences understanding of a particular concept. For example, concept A was taught in the morning to class C1 in the ESF order, whereas in the afternoon class C2 was taught in the FSE order. To expose students to as many orders as possible, concept

B was taught using SFE in the morning and SEF in the afternoon section, and so on. Hence, each concept was taught in all three worlds of embodied, symbolic and formal mathematical thinking to each class, but in different orders. To try to gain some measure of students' understanding the lecturer employed contingent teaching, incorporating clicker quiz questions into the presentation of the teaching material. The design of suitable quizzes, posed at the right moment, was a crucial part of the project. The students were also given clicker opinion questions throughout the lecture regarding their preference of the order of presentation, to gauge the reaction of the class and make sure everyone was following. These included questions such as: How would you like to be taught this particular concept? (a) by a definition, (b) an example, (c) a picture. Now that you have seen the examples, what would you prefer to see next? Students were also asked a number of True/False opinion questions regarding their understanding. (e.g. I fully understand this theorem. T/F). Data was collected from the student clicker quizzes to try to establish the effect of a particular order on student attitudes and learning. It was noticeable that this approach changed the class atmosphere and it appeared that students were more involved and engaged, started to respond better and embraced the lecture style.

Other forms of data gathering occurred through the lecturer's daily journals for each lecture, specific in-class activities, homework assignments, tests, final examination questions and student interviews, which are still under analysis. Of the 82 students in the classes 68 gave consent for their data and course material to be used. In addition, during the final two weeks of the course, 10 student volunteers from classes C1 and C2 were given semi-structured interviews by a colleague, using questions such as: Did you notice any difference in the way Dr. Stewart taught different concepts in her lessons this semester? If so, in what way were they different? If not, was her approach in teaching concepts always the same? If you prefer teaching to start with one particular approach, which one would it be? Can you explain why you prefer this approach? Do you think that step should always come first (second, third), or are there situations where you would prefer a different order? Which type of thinking do you prefer, or feel most comfortable with: embodied, symbolic or formal? Do you think any of these types of thinking is more important than the others in mathematics? If so, which one? What do you think about clicker questions (quizzes and opinion)?

The research questions for this part of the study are: Is there a preferred order of exposure to linear algebra concepts (based on Embodied, Symbolic and Formal)? Do different categories of students (eg geometric, symbolic and versatile thinkers) prefer different orders? Is there any influence of order of presentation on understanding?

## **RESULTS AND DISCUSSION**

We reiterate that concepts were taught to each class using all three worlds of embodied, symbolic and formal mathematical thinking, but in different orders. This section considers several examples of the effect of these different orders.

### Example 1: Linear Combination and Span, FSE versus ESF

The concept of linear combination was introduced in two different ways: one class, C1, met the concept first through its formal definition, then through symbolic examples and finally through embodied pictures (FSE), while the other class, C2, met the concept first through a pictorial embodied explanation, then symbolic examples and finally through the formal definition (ESF). Clicker responses were used to gather answers to questions. Of course, one problem with some of the categories used (see below) is that they are not necessarily mutually exclusive but still force a choice. For example, a student could think that their understanding is complete *and* that they didn't get much from the definition.

Following three geometric examples of linear combinations in  $\mathbb{R}^2$  and  $\mathbb{R}^3$ , the ESF students in C1 were asked to use the clickers to select from: A) Pictures were fine but I need a definition to understand the concept and B) Examples are all I need to understand the concept. 36% chose A) and 64% B), indicating that even at this stage the embodied view was useful for a number of students, and most preferred to add examples than a definition. In contrast the FSE group of students, C2, was first show a formal, algebraic definition and asked to select from: A) Now that I have seen the definition my understanding is complete, B) I didn't get much from the definition, C) I need some examples and D) I need a picture. The percentages choosing each option were 33%, 14%, 42% and 8%, respectively, with 3% not selecting any. This suggests that a third of the students felt that the definition was sufficient for them to understand the concept, but a larger percentage still needed some examples.

The second step for the ESF group (C1) was the introduction of some symbolic, matrix-based examples and a link to consistent solutions of the equation  $A\mathbf{x} = \mathbf{b}$ . Once again they were asked to choose from the options A) I completely understand the concept, B) I need to study a bit more to understand this and C) I am ready to see a definition of the concept. 44% now claimed to understand the concept completely but 52% still needed more study to understand. Only 4% said they were ready for the definition. The FSE group (C2) had exactly the same symbolic, matrix-based examples and link, but were not asked about their understanding at that point.

The final phase for the ESF students was to be given the formal, algebraic definition of linear combination and following this they used the clickers to choose between A) now that I have seen the definition my understanding is complete and B) I didn't get much from the definition. In the event, 73% said they now understood completely and 27% did not get much from the definition. At this point the FSE group was given the same three embodied, geometrical examples that the ESF students started with. Finally they were given the choice between A) Pictures were great, I always learn better when I see a picture, B) I am not in favor of pictures, I learn mainly from examples and C) I first look for a definition. 36% were pleased to see the pictures (A), 50% said they learn mainly from examples and 14% went for the definitions option. They weren't asked about their understanding at this stage.

Following the lectures on linear combination the two groups were taught span, which, of course, is based on the concept of linear combination. The class C1 was taught this using the order FSE, the order C2 had received first, while the FSE students in C2 were presented with ESF ordered material, so both groups experienced each order of presentation. After the formal definition the C1 students responded to A) I completely understand the definition, B) This definition is very abstract – I don't understand it and C) I need more time to understand it, with just 13% saying they understood it, 45% saying they didn't and 39% wanting more time. After being shown a geometric picture 21% chose A) I am still not sure about the span, while 79% selected B) I am happy about the idea of span. Due to time constraints it was the start of the next week when the C1 students were asked to choose from the options: A) I can't remember much from last week; B) I remember the definition of Span; C) I remember some pics; D) I remember the story: *once upon a time there were two vectors, together they spanned the entire  $\mathbb{R}^2$*  and E) I remember the examples. 30% claimed not to remember much, 9% said they remembered the definition and 9% some pics, while 39% could recall the story of the two vectors and 13% the examples.

For group C2, following the geometry 20% said A) I am not sure about the span. I don't really get it, but 80% chose B) So far what you are saying does make sense. Following some symbolic, matrix examples 63% were convinced that A) I completely understand it now, 8% said B) I need a concrete definition now and 26% went for C) I need more examples (and 3% were uncommitted). Interestingly, after they had been presented with the formal definition only 44% said A) I completely understand the definition, 14% thought B) This definition is very abstract – I don't understand it and 42% were in the category C) I need more time to understand it.

We see that the students preferred different routes to using the formal definition to gain understanding of linear combination and span, but this was an essential part of the picture for them, often cementing together their geometric and matrix ideas.

### **Example 2: Subspaces, FSE versus ESF**

The concept of subspaces was introduced using the same orders FSE and ESF as linear combination. The contrast between the initial introductions is quite stark. After seeing the formal definition of a subspace and the theorem requiring to check closure for a non-empty subset to be a subspace, only 37% of the class felt they understood anything, the rest feeling lost (22%) or in need of more time to think about it (41%). On the other hand, after the pictorial embodied introduction 83% felt they had at least partial understanding (44% thought they had complete understanding). Asked what would help them understand better, about 80% of both groups of students wanted (symbolic) examples. Fortunately the plan for both classes was to supply that very need. After seeing some symbolic examples almost all students in both classes felt they had at least partial understanding (97% of the FSE class and 91% of the ESF class) but only 21% of the FSE class felt they had full understanding whereas 71% of the ESF class did. By the time each class had experienced all three worlds, however, their

feelings were essentially identical, with 68% (FSE) or 69% (ESF) feeling they had full understanding, and another 29% or 23% (respectively) claiming partial understanding.

Students' actual understanding was sampled at the end of the same lecture, with two true-false questions, and again with another true-false question at the start of the following lecture. Students in the ESF class performed slightly better at the end of the first lecture (with 85% getting the first question correct and 95% the second, compared with 76% and 93% for the FSE class) but by the time of the following lecture there was hardly any difference between the two groups of students with the ESF class actually performing slightly worse this time (with 49% of the ESF class choosing the correct option and 54% of the FSE class).

### **Student interviews**

In the interviews students displayed a wide variety of preferences while often cautioning that not all concepts would lend themselves to the same treatment and that not all students would have the same learning styles.

When asked to nominate which of the three worlds (embodied, symbolic or formal) they felt most comfortable, eight of the ten students chose the symbolic world. However, one of these (Ed) qualified his answer: "Symbolic is the easiest for me but I enjoy formal thinking the most." The other two students both saw themselves as visual learners, but Rod went on to say that "in the cases where the pictures won't work I guess symbolic would be the best" and Wade pointed out that in some cases "the picture either might throw you off or, if you don't know what it's talking about, it's not going to help you learn it." This is consistent with what we saw in Example 1, where about 80% of both classes asked for more (symbolic) examples when the concept had been introduced through either the formal or the embodied world in Example 1.

Students were also asked if they had a preferred order in which they would like to meet the embodied, symbolic or formal aspects of a new concept. Most, but not all, of the interviewed students felt that the formal aspect should come last. Typical of the non-visual people was Jenny: "I like to see the examples on how to work through it and then maybe go back and understand what we did from the definition side of it." On the other hand Rod identified himself as a visual learner: "The visual idea of something usually is enough to make it work out for me. So whenever I get examples and then definitions I can understand it better." On the other hand, two students could see reasons for looking at the formal aspect first. James, studying mechanical engineering, preferred to follow the habit of his engineering classes where:

What we'll do is, first we'll prove or do a derivation of what we're about to do; then we'll do an example of what we just derived; and then our professor, most of the time, will show a visual representation of what we just did. So that's just how I think.

Andrew didn't "know if pictures would make sense coming before the theorem" but he saw a role for the formal aspect at the start and the end:



but I do, like I said theorem I like to see before and after I think. I think it makes more sense because like seeing it before at least it introduces you to it even if you don't know what it means and then you see like examples and maybe a picture and then you see the theorem afterwards it makes, it kind of cements it a little bit more and then you can see how it relates to an actual example.

The majority view here perhaps reflects what we saw in Example 2, where presenting the formal aspect of subspaces first resulted in only 37% feeling they had understood anything, as opposed to 83% when the embodied aspect was put first.

Several students emphasized the importance of looking at all three aspects (embodied, symbolic or formal) even when they had definite preferences for the order in which they wanted meet these aspects. Sara preferred the order ESF but rejected the idea that one of these might be more important: "No, I think they all go together equally." But John knew that if he "had to say" which was more important, it would be the formal: "I'm trying to get better at formal. I'm a math major, I have to get better at that." But there was a feeling that this only applied to mathematics majors. James pointed out that most of the students in his class were engineering or meteorology majors and for them "application-wise, I think the symbolic world would probably be more important." Ed echoed this distinction: "if I'm going to enter mathematics as a profession, then I need to be very well grounded in formal mathematics, more so than in symbolic mathematics, like, symbolic is more the applied mathematics area."

## CONCLUSION

The initial analysis of the data above shows that students noticed the fact that the lecturer was tailoring the material to their needs, and they appreciated this. The students were always keen to see examples of the concepts and we found that student affect is much more positive when concepts are first met in the embodied or symbolic worlds, but that once students have met all three aspects of a concept there seems to be little difference in the levels of understanding gained. One of the aims of the lectures was for students to appreciate for themselves the power of formal world thinking, and that examples alone are often insufficient. Most students did value the formal definitions of concepts, whenever they were introduced, but often found them more challenging. This may be because it takes time to appreciate fully all the details of a formal definition and why they are important. By the end of the course student perspectives on formal aspects of mathematics, definitions, theorems and proofs, were much more positive than at the start. Integrating the power of the mathematical thinking in each of the three worlds is not a simple matter. We hope that the results of this study will contribute to the thinking and practice of the many university teachers who are seeking to do so.

## References

- Abrahamson, L. (2006). A brief history of networked classrooms: Effects, cases, pedagogy and implications. In D. A. Banks (Ed.), *Audience response systems in higher education: Applications and cases* (pp. 1-25). Hershey, PA: Information Science Publishing.

- Draper, S. W., & Brown, M. I. (2004). Increasing interactivity in lectures using an electronic voting system. *Journal of Computer Assisted Learning*, 20(2), 81-94.
- Dubinsky, E., & McDonald, M. (2001). APOS: A constructivist theory of learning. In D. Holton (Ed.), *The teaching and learning of mathematics at university level: An ICMI study* (pp. 275-282). Dordrecht: Kluwer Academic Publishers.
- Hannah, J., Stewart, S., & Thomas, M. O. J. (2013). Emphasizing language and visualization in teaching linear algebra. *International Journal of Mathematical Education in Science and Technology*, 44(4), 475-489. doi: 10.1080/0020739X.2012.756545
- Harel, G., & Tall, D. O. (1989). The general, the abstract and the generic in advanced mathematical thinking. *For the Learning of Mathematics*, 11(1), 38-42.
- Stewart, S., & Thomas, M. O. J. (2009). Linear algebra snapshots through APOS and embodied, symbolic and formal worlds of mathematical thinking. In R. Hunter, B. Bicknell, & T. Burgess (Eds.), *Crossing divides: Proceedings of the 32<sup>nd</sup> annual conference of the Mathematics Education Research Group of Australasia* (Vol. 2, pp. 507-514). Wellington, New Zealand: MERGA.
- Tall, D. O. (2004). Building theories: The three worlds of mathematics. *For the Learning of Mathematics*, 24(1), 29-32.
- Tall, D. O. (2008). The transition to formal thinking in mathematics. *Mathematics Education Research Journal*, 20(2), 5-24.
- Tall, D. O. (2010). Perceptions, operations and proof in undergraduate mathematics. *Community for Undergraduate Learning in the Mathematical Sciences (CULMS) Newsletter*, 2, 21-28. Retrieved from <http://www.math.auckland.ac.nz/CULMS/wp-content/uploads/2010/08/CULMS-No2-Complete-v2.pdf>
- Thomas, M. O. J., & Stewart, S. (2011). Eigenvalues and eigenvectors: Embodied, symbolic and formal thinking. *Mathematics Education Research Journal*, 23(3), 275-296.
- Wawro, M., Sweeney, G., & Rabin, J. (2011). *Subspace in linear algebra: Investigating students' concept images and interactions with the formal definition*. *Educational Studies in Mathematics*, 78, 1-19. doi: 10.1007/s10649-011-9307-4
- Wawro, M., Zandieh, M., Sweeney, G., Larson, C., & Rasmussen, C. (2011). *Using the emergent model heuristic to describe the evolution of student reasoning regarding span and linear independence*. Paper presented at the 14<sup>th</sup> Conference on Research in Undergraduate Mathematics Education, Portland, OR.

# A LONGITUDINAL ANALYSIS OF THE RELATIONSHIP BETWEEN MATHEMATICS-RELATED AFFECT AND ACHIEVEMENT IN FINLAND

Markku S. Hannula, Emmanuel Bofah, Laura Tuohilampi, Jari Metsämuuronen

University of Helsinki, Finland

*In this paper, a nationally representative longitudinal data of mathematics learning outcomes in Finland is analyzed in order to determine the direction of causality between mathematics-related affect and achievement. First, the results indicated that students' mathematical achievement, emotion, and self-efficacy were significantly stable over time. Different models were estimated to test the reciprocal relationship between students affect and achievement. The results indicated that mathematics achievement and self-efficacy have a reciprocal relation, where the dominant effect is from achievement to self-efficacy. The results indicate also a weaker unidirectional effect from achievement to emotion.*

## INTRODUCTION

Emotions, attitudes and motivation play an important role in contemporary research on mathematics education. Attitudes and motivation are important, because they determine how much people choose to study mathematics after it becomes optional and in many countries the society has a shortage of mathematically educated persons in scientific and technical fields. Moreover, the needs of society increasingly emphasize creativity, problem solving, and other higher-level cognitive processes, which are intrinsically intertwined with emotions. Although it is well known that mathematics-related affect and achievement are related, we do not yet understand well enough how these develop in interaction with each other.

In this study, we shall focus on two affective traits (enjoyment and self-efficacy) and their relationship with achievement in mathematics. There is much evidence for the positive correlation between these three (e.g. Hannula & Laakso, 2011; Roesken, Hannula & Pehkonen, 2011), but there is need to study further their interaction and development throughout the school years. The present paper will analyze the longitudinal development of mathematics-related achievement, enjoyment and self-efficacy in the Finnish comprehensive school.

Several studies have explored the relationship between mathematical affect and achievement. Ma and Kishor (Ma & Kishor, 1997a, b; Ma, 1999) have summarized much of that research in their meta-analyses. They found a negative correlation between mathematics anxiety and achievement that was consistent over gender groups, age groups and ethnic groups (Ma, 1999). Their results suggested that there would be a causal direction from liking mathematics to achievement in mathematics (Ma & Kishor, 1997a) and the positive correlation between self-concept and achievement in

mathematics was found to decrease as students grow older (Ma & Kishor, 1997b). International comparative studies have also produced large databases for modeling the causal relationships of different variables. Williams & Williams (2009) studied the relationship between self-efficacy and performance in mathematics for 33 nations, finding a good fit to the data in 30 nations and support for a reciprocal determinism in 24 of these. Their results for Finland showed that the effect from mathematical self-efficacy to achievement is statistically significant, but small in comparison to most other countries, and the effect in the opposite direction is one of the largest in OECD. A longitudinal study in Finnish comprehensive schools (from grade 5 to grade 6 and from grade 7 to grade 8) suggested that the main causal direction would be the opposite: from self-efficacy to achievement. However, for the older subsample a significant effect was also found among female students from achievement to self-confidence, supporting the hypotheses of a reciprocal linkage (Hannula, Maijala & Pehkonen, 2004).

The longitudinal studies analyzing the relationship between affective and cognitive variables in mathematics are still few in number. When student socio-economic status, openness and conscientiousness of Italian students were controlled, the cross-lagged effects from self-efficacy (at the age of 13) to achievement (at the age of 16) was on the same level as the effect from achievement (at the age of 13) to self-efficacy (at the age of 16) (Capara, Vecchione, Alessandri, Gerbino, & Barbaranelli, 2011). A review of eight Japanese longitudinal studies (Minato & Kamada, 1996) found no predominance of either attitude or achievement in most of the studies. However, in the few instances that predominance was found, the causal direction was from attitude to achievement. An Australian longitudinal study measured also the students' motivational orientations and found effects between self-concept and achievement to be of similar magnitude for both directions, while the causal direction for achievement and motivation was from achievement to motivation (Seaton, Parker, Marsh, Craven & Yeung, 2013). This suggests that self-efficacy rather than motivational orientation is a primary determinant for the longitudinal development of mathematical competences. In addition, a dominant causal relationship from achievement to perceived usefulness of mathematics has been found in the Longitudinal Study of American Youth (Ma & Xu, 2004).

So far, we have found no longitudinal study including measures for both self-beliefs and emotions analyzing their reciprocal relationship with achievement. However, Green, Liem, Martin, Colmar, Marsh & McInerney (2012) included all three elements in a longitudinal design to test the self-system model of motivational development. In addition to academic self-concept, positive attitude towards school (emotion) and academic achievement test, they measured three types of motivation, and three behavioral measures. The Australian high school students responded to the survey twice, within one year intervals. The analysis of the data consisted of testing alternative models for both measurements separately and only then testing the model fit for a longitudinal design. Their analysis suggested that positive attitude – possibly together

with behavioral variables – mediated the effect of self-concept and motivation on academic achievement. The model where test performance would be directly influenced by all other variables was rejected due to poor model fit in the first stage of the analysis without testing it in the longitudinal design.

Summarizing the aforementioned studies, there seems to be strong evidence for a reciprocal relationship between academic self-efficacy and achievement. There is mixed evidence for the dominant direction of this relationship and for its development. With respect to the relationship between mathematics-related emotions and achievement the evidence is even less clear, but it suggests a reciprocal linkage, with the dominant direction possibly from emotions to achievement.

In the present study, we will analyze longitudinal data from Finland to study the relationships between achievement in mathematics and two affective measures: enjoyment of mathematics and self-efficacy in mathematics in a longitudinal design. Our aim is to determine the dominant direction of effect between the chosen affective variables and achievement in mathematics.

## **METHODS**

The data of this study has been collected by the Finnish National Board of Education (FNBE) to study the long-time development of Finnish comprehensive students' mathematics-related affect and achievement from the beginning of grade 3 to the end of grade 9. A nationally representative sample of intact grade 3 classes was selected for the first measurement in 2005. The same pupils were tested again in 2008 at the beginning of their sixth grade in their intact classes, hence increasing the sample size. At this stage, we reached 80 % of the original sample. A similar selection of intact classes of previously participated students was measured again in 2012 at the end of ninth grade, when we reached 60 % of the original sample. Total number students who took part in all three-time points was 3,502 (48% female). Metsämuuronen (2013) has reported the details of the sample, procedures, and instruments in the official assessment report. For the present analysis, we included also students who participated only the first two ( $n = 1,050$ ), or the last two measurements ( $n = 654$ ).

### **Measures**

The mathematics tests were composed by expert panels to measure the attainment of Finnish National Core Curricula (FNBE 2004) and the three tests shared several linking items. To make test scores comparable across grade levels, item response theory (IRT) was applied using the link items across grade levels to compute estimate test scores from each grade level to a common metric scale (see Béguin, 2000). The reliabilities were calculated for the subsample that responded to all three measures: mathematics enjoyment scale (four items, e.g. "I like to study Mathematics";  $\alpha$ :  $t_1 = 0.879$ ,  $t_2 = 0.879$ ,  $t_3 = 0.885$ ) and mathematics self-efficacy scale (four items, e.g. "Mathematics is an easy subject";  $\alpha$ :  $t_1 = 0.879$ ,  $t_2 = 0.879$ ,  $t_3 = 0.885$ ).

### **Statistical procedures and model fit**

Using Mplus 7.11 (Muthén & Muthén, 1998-2012), latent autoregressive and cross-lagged panel models were estimated. Latent autoregressive/cross-lagged models account for random measurement error by using multiple indicators at each time point. Using the cross-lagged model the reciprocal causal relationship between mathematics enjoyment, mathematics self-efficacy, and mathematics achievement can be estimated between different measurement time points. Model fit was evaluated with several fit indices: the chi-square difference test (Satorra & Bentler, 2001), the Comparative Fit Index (CFI > 0.90), and the Root Mean Square Error of Approximation (RMSEA < 0.08), and the Akaike (AIC: lower value indicates a better fit) (Brown, 2006). Missing data patterns were handled with Mplus feature of full information maximum likelihood (FIML). Analyzes was based on the Mplus robust maximum likelihood estimator (MLR), which is robust to non-normality and to control for the non-independence of observation (Muthén & Muthén, 1998-2012).

With respect to structural relations between students' self-efficacy, enjoyment and achievement over time, we initially estimated a baseline model with autoregressive but no cross-lagged paths. To account for the indicator-specific effects seeming common in longitudinal analyses because the same indicators are repeatedly measured (Geiser, 2013; Raffalovich & Bohrnstedt, 1987), we allowed for correlations between the measurement error (residual) variables that relate to the same indicator over time (e.g., Sörbom, 1975). We also allow residual to correlates for each time point to account for shared occasion-specific effects between the constructs at the same time point (Anderson & Williams, 1992; Geiser, 2013). The results indicate that the baseline autoregressive measurement model fits the data adequately well (model 1, table 1).

Additionally, because invariance of factor loadings over time is conceptually important we tested if the factor structure of self-efficacy and enjoyment were invariant across the three time points. To test the factorial invariance, we tested a model whereby all the factor loadings on self-efficacy and enjoyment were freely estimated (configural model) across the three measurement time points ( $\chi^2 = 3248.323$ ,  $df = 296$ , CFI= 0.957, RMSEA = 0.038) with models whereby the factor loadings were constrained equal ( $\chi^2 = 4499.981$ ,  $df = 312$ , CFI= 0.940, RMSEA = 0.044). There was support for the factorial invariance over the three measurement time points. For all subsequent analysis the factor loadings were constrained equal.

After establishing the stability model, we specified a structural model by including a cross-lagged path of measurement time point 1 and time point 2 in order to examine possible reciprocal relations between mathematics achievement, mathematics enjoyment and self-efficacy as depicted in Figure 1.

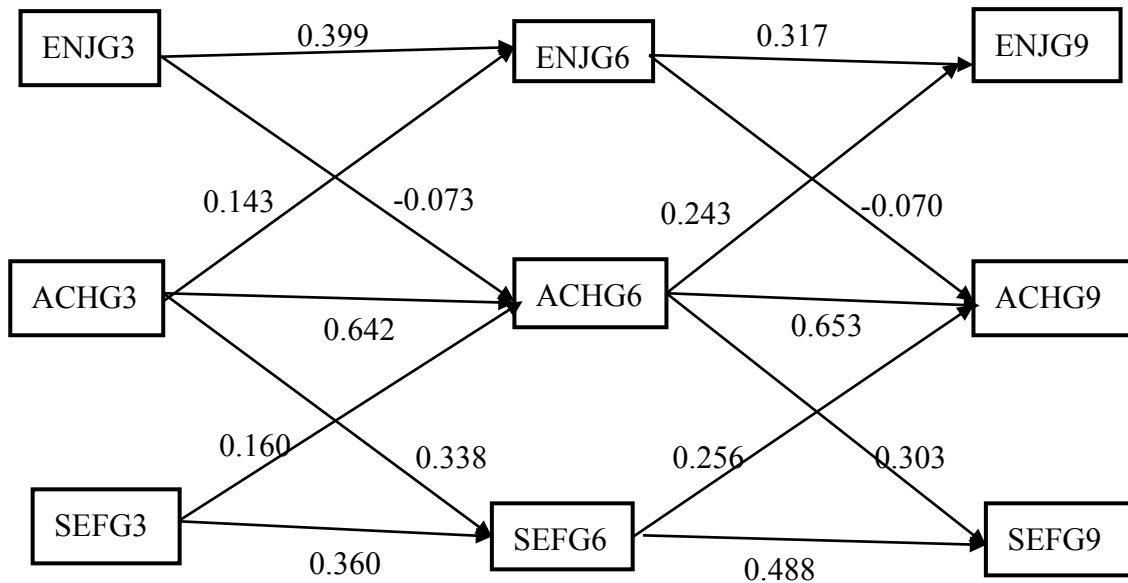

Figure 1: Latent autoregressive/cross lagged model measuring student's mathematics self-efficacy, enjoyment, and mathematics achievement on three measurement occasions (grade 3, grade 6 and grade 9). To avoid cluttering, only path estimates are shown. AchG3-AchG9 = Achievement at grade 3 to grade 9, EnjG3-EnjG9 = mathematics enjoyment at grade 3 to grade 9, SefG3-SefG9 = mathematics self-efficacy at grade 3 to grade 9.

## RESULTS

### Autoregressive effect of mathematics self-efficacy, enjoyment and achievement

The unidimensional path linking measurement at time point 1 (grade 3) and subsequent grades is used to access the autoregressive/stability effect. As all autoregressive effects were statically significant, a significant portion of individual differences has remained stable over time. The stability effect was much stronger and consistent for mathematics self-efficacy (from  $\beta = 0.360$  to  $\beta = 0.488$ ) and mathematics achievement ( $\beta = 0.642$  to  $\beta = 0.653$ ). Moreover, the findings indicated that mathematics enjoyment at grade 3 influenced mathematics enjoyment on grade 6 but mathematics enjoyment in grade 6 had smaller impact on mathematics enjoyment at grade 9.

### Cross-lagged effect between mathematics self-efficacy, enjoyment and achievement

Nonetheless, individual students' differences were not perfectly stable over time. This was further tested by comparing models with and without cross-lagged effects (table 1). First, the model without the cross-lagged structural path (M1) was compared with models with cross-lagged from students' achievement to students' affects (M2), and from affects to achievement (M3). As seen in table 1, the model fit and chi-square difference test indicated that models with cross-lagged effects account for the data better than the model without them. The model with all the cross-lagged effect (M4) was practically and significantly better than any other of the tested models. The

comparison (AIC) between models M2 and M3 indicates a better model fit for M2. Also from the bidirectional cross-lagged model (M4), we can see that the cross-lagged effect from mathematics achievement to affects ( $\beta = 0.143-0.338$ ) were larger than the corresponding cross-lagged effects from affect to achievement ( $\beta = -0.073- 0.256$ ). These findings suggest that the longitudinal effect from achievement to affect is stronger than the effect to the opposing direction. Overall, the cross-lagged effects were consistently smaller in size compared to the autoregressive coefficients, indicating that cross-lagged effect was less important than the stability of all three measured variables.

Model	MLR $\chi^2$	df	CFI	RMSEA	AIC	Comparison
No cross-lagged (M1)	4499.981	312	.940	.044	327912.090	
Cross-lagged from						M1 vs. M2
ACH <sub>T1</sub> -Affect <sub>T2</sub>	3503.168	308	.954	.039	326854.238	$\Delta\chi^2 = 990.001,$ $\Delta df = 4$
ACH <sub>T2</sub> -Affect <sub>T3</sub> (M2)						
Affect <sub>T1</sub> -Ach <sub>T2</sub>	4064.330	308	.946	.042	327460.032	M1 vs. M3
Affect <sub>T2</sub> -Ach <sub>T3</sub> (M3)						$\Delta\chi^2 = 478.595,$ $\Delta df = 4$
All cross-lagged paths (M4)	3187.793	304	.958	.037	326528.064	M1 vs. M4 $\Delta\chi^2 = 1348.144,$ $\Delta df = 8$ M2 vs. M4 $\Delta\chi^2 = 334.070,$ $\Delta df = 4$ M3 vs. M4 $\Delta\chi^2 = 842.432,$ $\Delta df = 4$

Table 1: Goodness-of-fit indices and chi-square difference tests of models tested. ACH= Achievement, Affect = mathematics enjoyment and mathematics self-efficacy, T1 = Time 1=Grade 3, T2 = Time 2= Grade 6, T3 = Time 3 =Grade 9. S = Scaling Correction Factor, CFI = Comparative fit index, RMSEA = Root Mean Square Error Of Approximation, robust maximum likelihood estimator (MLR), Akaike (AIC)

The correlations between the residual variables between the mathematics achievement, self-efficacy and enjoyment were statistically significant and small to medium ( $r_s = 0.165- 0.410, p_s < 0.001$ ), but the correlations between mathematics self-efficacy and enjoyment were higher ( $r_s = 0.647- 0.739, p_s < 0.001$ ). This indicated that a high



amount of shared situation-specific effects influence the self-efficacy and mathematics enjoyment constructs at the same measurement time

## DISCUSSION

The results of this longitudinal study support the view that mathematical self-efficacy and achievement are reciprocally linked and that the dominating direction of this relationship is from achievement to self-efficacy. Such a relation between self-efficacy and achievement could be characterized as evidence-based development of self-efficacy beliefs. Previous studies (Williams & Williams, 2010) suggest that this direction of the relationship may be characteristic for Finland. However, it should be noted that the effect of self-efficacy on achievement was larger for the older students. This supports the earlier hypothesis (Hannula, Majjala, & Pehkonen, 2004) that there might be a developmental trend from achievement-dominated relationship to a reciprocal relationship, which would eventually become a relationship dominated by self-efficacy beliefs.

Results of our study do not support the model suggested by Green et al. (2012), where the causal relation of these three variables would be from self-efficacy to achievement through emotions. In our data the cross-lagged effect was primarily from achievement to self-efficacy and we also found a unidirectional effect from achievement to emotions.

## References

- Anderson, S. E., & Williams, L. J. (1992). Assumptions about unmeasured variables with studies of reciprocal relationships: The case of employee attitudes. *Journal of Applied Psychology, 77*(5), 638.
- Béguin, A. (2000). *Robustness of equating high-stake tests*. Enschede: Febodruk B.V.
- Brown, T. A. (2006). *Confirmatory factor analysis for applied research*. New York: Guilford Press.
- Caprara, G. V., Vecchione, M., Alessandri, G., Gerbino, M., & Barbaranelli, C. (2011). The contribution of personality traits and self-efficacy beliefs to academic achievement: A longitudinal study. *British Journal of Educational Psychology, 81*(1), 78-96.
- Geiser, C. (2013). *Data analysis with Mplus*. New York: Guilford Press.
- Green, J., Liem, G. A. D., Martin, A. J., Colmar, S., Marsh, H. W., & McInerney, D. (2012). Academic motivation, self-concept, engagement, and performance in high school: Key processes from a longitudinal perspective. *Journal of Adolescence, 35*(5), 1111-1122.
- Hannula, M. S., & Laakso, J. (2011). The structure of mathematics related beliefs, attitudes and motivation among Finnish grade 4 and grade 8 students. In B. Ubuz (Ed.), *Proc. 35<sup>th</sup> Conf. of the Int. Group for the Psychology of Mathematics Education* (Vol. 3, pp. 129-136). Ankara, Turkey: PME.
- Hannula, M. S., Majjala, H., & Pehkonen, E. (2004). Development of understanding and self-confidence in mathematics: grades 5-8. In M. J. Høines & A. B. Fuglestad (Eds.),

*Proc. 28<sup>th</sup> Conf. of the Int. Group for the Psychology of Mathematics Education* (Vol. 3, pp. 17-24). Bergen University College: PME.

Ma, X. (1999). A meta-analysis of the relationship between anxiety toward mathematics and achievement in mathematics. *Journal for Research in Mathematics Education*, 30, 520-541.

Ma, X., & Kishor, N. (1997a). Assessing the relationship between attitude toward mathematics and achievement in mathematics: A meta-analysis. *Journal for Research in Mathematics Education*, 28(1), 26-47.

Ma, X., & Kishor, N. (1997b). Attitude toward self, social factors, and achievement in mathematics: A meta-analytic review. *Educational Psychology Review*, 9, 89-120.

Ma, X., & Xu, J. (2004). Determining the causal ordering between attitude toward mathematics and achievement in mathematics. *American Journal of Education*, 110(3), 256-280.

Metsämuuronen, J. (2013). Pitkittäisaineistoon liittyviä menetelmäratkaisuja [Methodological solutions regarding the longitudinal data]. In J. Metsämuuronen (Ed.), *Perusopetuksen matematiikan oppimistulosten pitkittäisarviointi vuosina 2005–2012* [The longitudinal assessment of mathematics learning outcomes for comprehensive education] (pp. 31-64). Helsinki, Finland: Opetushallitus.

Minato, S., & Kamada, T. (1996). Results on research studies on causal predominance between achievement and attitude in junior high school mathematics of Japan. *Journal for Research in Mathematics Education*, 27, 96-99

Muthén, L. K., & Muthén, B. O. (1998-2012). *Mplus user's guide* (7<sup>th</sup> ed.). Los Angeles, CA: Muthén & Muthén.

Raffalovich, L. E., & Bohrnstedt, G. W. (1987). Common, specific, and error variance components of factor models estimation with longitudinal data. *Sociological Methods & Research*, 15(4), 385-405.

Roesken, B., Hannula, M., & Pehkonen, E. (2011). Dimensions of students' view of themselves as learners of mathematics. *ZDM – The International Journal of Mathematics Education*, 43(4), 497-506.

Satorra, A., & Bentler, P. M. (2001). A scaled difference chi-square test statistic for moment structure analysis. *Psychometrika*, 66(4), 507-514.

Seaton, M., Parker, P., Marsh, H. W., Craven, R. G., & Yeung, A. S. (2013). The reciprocal relations between self-concept, motivation and achievement: Juxtaposing academic self-concept and achievement goal orientations for mathematics success. *Educational Psychology*, 34(1), 49-72.

Sörbom, D. (1975). Detection of correlated errors in longitudinal data. *British Journal of Mathematical and Statistical Psychology*, 28(2), 138-151.

Williams, T., & Williams, K. (2009). Self-efficacy and performance in mathematics: Reciprocal determinism in 33 nations. *Journal of Educational Psychology*, 102(2), 453-466.

# A THEORETICAL FRAMEWORK FOR THE FUNCTION OF GENERALIZATION IN LEARNING MATHEMATICS

Toru Hayata, Masataka Koyama

Graduate School of Education, Hiroshima University, Japan

*The purpose of this study is to clarify for what students do generalize something in learning mathematics. In this study, we make a distinction between generalization and extension, and focus on the function of generalization in terms of its meaning, purpose, and usefulness. Through reviewing literature on generalization and philosophical considerations, six functions with their examples are identified; variablization, purification, unification, discovery, association, and socialization. We propose a new theoretical framework for the function of generalization in learning mathematics, suggesting that the framework has possibility of a principle of didactics for teachers and a guideline in forming mental habit for students.*

## INTRODUCTION

In mathematics classrooms, we evaluate more students' mathematics activities based on mathematical knowledge than their static mathematical knowledge. Students are expected to be improved as the result of their activity. We call such improvement by the term of *learning*. In learning mathematics, generalization is one of most important mathematics activities. Generalization is to extending the range of reasoning and/or communication from the particular (concrete something) to the general (abstract something). In that sense, generalization is essential to mathematics. In our daily life, however, knowledge about the particular is enough for most of our purpose, and such knowledge sometimes may be more useful than knowledge about the general. Thus, students may have a question; "For what do we generalize it?". It's a natural question from the *viewpoint of students*. In fact, students do not always make any endeavors to generalize in learning mathematics (cf. Tatsis & Tatsis, 2012), though our human mind has an ability of generalize something and a tendency to generalization since very young age (cf. Vinner, 2011).

However, in mathematics education, the authors of this paper believe in the value of that students find its meaning, purpose, and usefulness of generalization by themselves through mathematics activities. Therefore, we will investigate and clarify an epistemological motivation of generalization for students. In this paper we use the term "*function of generalization*" as the meaning, purpose, and usefulness of generalization for students in learning mathematics, and discuss the following two research questions:

RQ1: What are specific and characteristic functions of generalization for students in learning mathematics?

RQ2: How do the functions of generalization improve students' mathematics learning?

For RQ1, previous studies pointed out mainly two suggestions. First, for example according to Davydov (2008), generalization means that one investigate invariant(s) and associate the invariants with a label. As a result, generalization yields useful structures or systematization (pp.74-75). It's no doubt a function of generalization, and the view is commonly shared among some researchers (cf. Radford, 1996). However, this function is not specific to mathematics but common in all scientific disciplines. Furthermore, as Davydov (2008) pointed out, this function is that generalization *functioned* as a result identified when one observer makes an analysis of a completed and static mathematical (and scientific) knowledge. Hence, a student as a learner may not think “I associate the invariants with the label for systematization!” The interest for us is the function of generalization in students’ activities of learning mathematics. The function of generalization must be identified from the students’ viewpoint, though it is not contradicted with the Davydov (2008). Second, previous studies on generalization in mathematics education pointed out the function of *variablization* that is to extending a range of reasoning and/or communication (Ursini, 1990; Dörfler, 1991; Iwasaki & Yamaguchi, 1997; Radford, 2001). This function is an important function of generalization. However, variablization is one of functions of generalization, because some researchers pointed out other functions of generalization.

### DISTINCTION BETWEEN GENERALIZATION AND EXTENSION

In this study, we use the term of generalization as “recognition that has epistemological direction from the particular to the general”. The necessity of this definition is derived from the fact that similar recognition called extension does not have this direction. The authors (Hayata & Koyama, 2012) make a distinction between generalization and extension, and formalize them as following in Figures 1 and 2 respectively:

$D$  is a field.  $D'$  is a wider field than  $D$ .  $M$  is a meaning in the field  $D$ .  $M'$  is an established meaning in the field  $D'$ .

Generalization: Recognition establishing  $M$  in  $D$ , and extending  $D$  to  $D'$  without changing  $M$

Extension: Recognition incorporating  $D$  into  $D'$  such that if  $D'$  is limited to  $D$ ,  $M'$  is equivalent to established  $M$

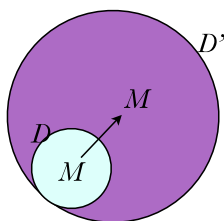

Figure 1: Model of generalization

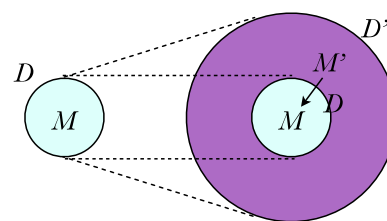

Figure 2: Model of extension (Tomosada, Himeda, & Mizoguchi, 2006, p. 9)

For example, when students noticed that the sum of interior angles is straight angle ( $M$ ) in concrete triangles ( $D$ ), thereby they suppose that it is case of all triangles ( $D'$ ). This recognition is generalization because  $M$  is not changed. On the other hand, for

example, when students work on multiplication of decimal numbers (D') for the first time, they cannot solve the multiplication by using the meaning of multiplication as repeated addition (M) in natural numbers (D). The decimal number multiplication can be solved with the meaning of proportion (M'), and this meaning is equivalent to repeated addition in natural numbers. So, by its definition, this recognition is extension.

In this study, we make the above distinction between generalization and extension, and focus on the function of generalization in terms of its meaning, purpose, and usefulness of generalization for students in learning mathematics. On the other hand, we do not distinguish between algebraic generalization and geometrical generalization for the purpose of this study in spite of that there are important cognitive differences between them (Iwasaki & Yamaguchi, 1997), because in both generalizations one must consciously see algebraic/geometrical symbols as general symbols (e.g.  $n$  is general natural number, and triangle ABC is general triangle).

## METHODOLOGY

As mentioned above, previous studies mainly discussed the function of generalization identified in the static and completed mathematics knowledge. Thus, their method is, for example, to analyse the history of mathematics (cf. Radford, 1996). However, there is no whole picture/framework for the function of generalization in mathematics activities. Without a framework, we cannot see and analyse any students' actual learning activities of mathematics in school classroom practices. For this reason, in this study the authors adopt the methodology of analyzing previous studies on generalization in terms of its meaning, purpose, and usefulness in order to extract implicit functions of generalization from the studies, carefully consider them, and organize them in a framework. In this paper, we analyze Polya (1954), Dörfler (1991), Ito (1993), and Tatsis and Tatsis (2012), because all of them epistemologically consider generalization in mathematics from the learner's viewpoint, and reveal the nature of generalization without restricting generalization to any specific mathematical context. In the following, as a result of the analysis, six identified functions of generalization (*variablization*, *purification*, *unification*, *discovery*, *association*, and *socialization*) are presented with their examples, and a new theoretical framework consisted of the six functions and their structure is proposed.

## SIX FUNCTIONS OF GENERALIZATION IN LEARNING MATHEMATICS

### Variablization

In short, the widely accepted meaning of generalization is to extending the range of reasoning. When one intends to extend the range, some attributes of the particular at hand are ignored and abstracted to become variables. For example, when students find out that area of a concrete rhombus ABCD with diagonals of AC (9cm) and BD (6cm) can be calculated by  $9 \times 6 \div 2$ , and from it they infer that the area of all rhombuses can be calculated by "diagonal  $\square$  another diagonal  $\square 2$ ". In this case, the students see length

of sides, inner angles, and so on as not essential attributes, thus these attributes will become variables, while the angle between two diagonals is not variable. The variablized attributes are dealt as algebraic variables, and can be substituted by any concrete values. As a result, students can know all objects in a set (ex. set of rhombus) nevertheless there is infinite number of objects in the set. We call this characteristic function *variablization*. This function leads to construct new class. The variablized objects are more or less isolated from physical objects. Thus, some symbols are needed to deal with the objects. For this reason, some researchers emphasized the importance of generalization in algebra. The variablization is important function of generalization, but it is not enough for learning algebra (cf. Dörfler, 2008).

### Unification

There is another case of generalization as “extending the range of reasoning”. One recognizes that known various particulars are integrated by single notion, and therefore elements in a set are increased. As a result, in such case, the range of reasoning also is extended. For example, let’s consider the same example of area of rhombus used in explaining the variablization. The area formula “diagonal  $\square$  another diagonal  $\square 2$ ” for rhombus is also applied to kite, because the formula depends only on the condition that angle between two diagonals makes a right angle, and because that angle between two diagonals is also right angle. In this case, two particulars (area of rhombus and area of kite) are unified by single notion (area formula). Thereby the range of the formula that calculates area of rhombus is extended. We call this characteristic function of generalization *unification*. According to Polya (1954), sometimes we can surprisingly unify different objects by single notion through generalization. We need pay attention to this different function unification from the function *variablization*.

### Purification

In actual problem solving, there are many situations where one does not always intend to work the function variablization of generalization. In such situation, for solving the problem easily one removes the attributes appeared unnecessary from the original problem. For example, let’s think about the problem to find  $\sqrt{103 \times 102 \times 101 \times 100 + 1}$ . If students must solve this problem without using any devices, they have to work on a quixotic challenge to find  $\sqrt{106110601}$ . Thus, some students are motivated to conjecture that generalizing the problem may be useful for solving it. They express it generally, and try to factorize  $\sqrt{(n+3)(n+2)(n+1)n+1} = \sqrt{n^4 + 6n^3 + 11n^2 + 6n + 1}$ . In this case, to factorize the generalized  $(\sqrt{n^4 + 6n^3 + 11n^2 + 6n + 1} = \sqrt{(n^2 + 3n + 1)^2} = n^2 + 3n + 1)$  is easier than to find  $\sqrt{106110601}$ . Finally, they substitute  $n=100$  for the equation, and get the answer to original problem is 10301. In this case, the generalization of “extending the range of reasoning” is not purpose but means. We call this characteristic function *purification*. Dirichlet and Dedekind (1999) and some researchers pointed out “As it often happens, the general problem turns out to be easier than the special problem would be if we had attacked it directly (p. 13; quoted in Polya (1954: 29))”.

## Discovery

According to Giusti (1999), new mathematical knowledge is invented implicitly while solving a problem and subsequently discovered as valuable object. In deed, Giusti (1999) pointed out that method of solving problem of planetary orbit (i.e. differential) invented the notion of limit implicitly. In school mathematics, we can find similar examples of generalization leading to a “discovery”. For instance, in the above example used for the *purification* (find  $\sqrt{103 \times 102 \times 101 \times 100 + 1}$ ), one can discover new proposition; “the value of  $\sqrt{(n+3)(n+2)(n+1)n+1}$  is always natural number  $n^2 + 3n + 1$ ” by generalizing the original problem. This proposition was not expected when students tried to solve the problem. We call this characteristic function *discovery*. According to Tatsis and Tatsis (2012), the function *discovery* of generalization is for students to “grasp” the deeper underlying structure of mathematics.

This function is closely related to the Dörfler’s notion of “symbols as objects”. According to Dörfler (1991), at first the abstracted something is associated with cognized particular(s), then, they are separated in the process of generalization. As a result, the abstracted something with symbols become independent object. He called this process as “symbols as objects”. As the above example indicates, the function *discovery* is interpreted as our conscious evaluation of the independent object.

## Association

In learning mathematics, new mathematical objects (knowledge, concepts, and so on) are constructed in mathematical activities. The something new should be meaningful for students. According to Howson (2005), there are two methods to create meaning. The first is to construct geometrical (graphical) model such as Poincaré Disk Model in mathematics, and number line for arithmetic operations in school mathematics. The second is to associate known objects with new object. The second has two methods in detail; to investigate and organize the connection between known objects with new object, and to construct new object by using known objects and inference rules.

Here, if we interpret “known objects” in the latter method of the second as “the particular”, we can say, new object that is constructed by using the particular and inference rules has meaning. We call this characteristic function *association*. For example, according to Howson (2005), one can meaningfully construct integer (the general notion) by using natural number (the particular) and inference rules. In school mathematics, for example, students have their meaning for general triangle that is invisible and inexistent, because they construct general triangle by being based on particular triangles. Ito (1993) focused on this function and developed his learning theory, and analyzed elementary school students. As a result, he pointed out that the students had spontaneous attitude to use this function in order to construct new objects. In mathematics classroom, usually the function *association* does not become obvious. Rather, the function seems work implicitly in students’ mind in learning mathematics.

## Socialization

For example, if one says that the next term in the number sequence of 1, 2, 3, 4, 5, 6, ... is 727, most people may not agree to it, and say that answer is 7. If those who wants to convince others that the next term is 727, they must present that the sequence  $\{a_n\}$  can be generalized such as  $a_n = (a-1)(a-2)(a-3)(a-4)(a-5)(a-6) + n$ . In this example, both 7 and 727 are correct. As this example shows, however, other people do not always accept an individual subjective cognition even if the individual cognition (e.g. 727) is reasonable for the person without making the reason public. Thus, if the person wants to make one's own cognition be socially acceptable knowledge among other people, the generalization is required. Typically, we can say that Euclid described *The Element* with the intention to generalize the known and accepted propositions for socialization. This social aspect of generalization is emphasized by Dörfler (1991). We call this characteristic function *socialization*. Because the socialization means to open own cognition to other people, the function plays a very important role in constructing sound mathematical knowledge.

The function *socialization* of generalization usually works implicitly, especially from students' viewpoint. When students' cognition meet the counterintuitive, the function may become obvious. Nevertheless, the function socialization always plays very fundamental roll in the activity of learning mathematics in school classroom.

## A FRAMEWORK FOR THE FUNCTION OF GENERALIZATION

In this section we will organize the six functions for making a theoretical framework. The above examples and consideration suggest that there is epistemological order from *variablization* to *unification*, and from *purification* to discovery respectively. In fact, Polya (1954) argued that *unification* is more higher than *variablization*, and likened it to the proverb; "To dilute a little wine with a lot of water is cheap and easy. To prepare a refined and condensed extract from several good ingredients is much more difficult, but valuable (p.30)". On the other hand, their examples imply that *association* and *socialization* are usually functioning implicitly, but both play fundamental rolls in learning mathematics. In addition, *association* and *socialization* are in their nature different from other four functions. They are not exclusive, and play different roll in constructing meanings for oneself or other people. Therefore, we propose a hypothetical structure of the six functions of generalization in Figure 3.

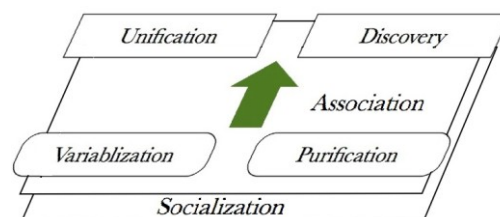

Figure 3: A hypothetical structure of the six functions of generalization

The framework consisted of six functions and their structure implies three didactical suggestions. First, teacher should design didactical situations where students can



discern meaning of the six functions of generalization (ex. purification and/or unification). It is the answer to the students' question; "For what do we generalize it?". Second, the structure shown in Figure 3 has possibility of a principle of didactics for designing mathematics classes. For example, if teacher intends to promote the unification in a mathematics class, the unification should be set up after the variablization or the purification. If teacher intends to promote students discern the socialization and/or the association, it is latent until after teacher expose students to other functions in a mathematics class. In a mathematics class, when one function of generalization is changed, teacher should give students the needed didactical support for making them be aware of the change "for what we do generalize it". Third, the most important suggestion is that the structure may become a guideline in forming mental habit for students through their experiencing the functions of generalization in mathematics classes. For example, Figure 3 shows that after activity of variablization, students do the activity of unification, and then reflecting on the association. However, it is difficult for students at the beginning do these activities without any didactical supports by teacher. Hence, if mathematics classes are usually planed based on the structure in Figure 3, it may become a guideline in forming mental habit for students, for example, "we have variablized this notion, so maybe we can unify other objects!" We expect that the formed mental habit could support students use the functions of generalization, leading to enjoy and endeavor their generalization as genuine mathematics activity.

## CONCLUDING REMARKS

In this paper, as the answer to RQ1, we identified six functions with their examples of generalization; *variablization*, *purification*, *unification*, *discovery*, *association*, and *socialization*. We proposed the new theoretical framework consisted of the six functions and their structure for generalization in learning mathematics. Then, as the answer to RQ2, we implied three didactical suggestions for teaching and learning mathematics in classroom. First, teacher should design didactical situations where students can discern meaning of the six functions of generalization. Second, the structure has possibility of a principle of didactics for designing mathematics classes. Third, the structure may become a guideline in forming mental habit for students through their experiencing the functions of generalization in mathematics classes.

The following are main tasks to be tackled in the future research. First, we need to plan and practice mathematics classes based on the framework for the function of generalization in classrooms. Second, the functions and their structure need to be more refined with empirical data and philosophical consideration. Third, we need to investigate and sequence in detail the differences in the function of generalization for students in learning mathematics from elementary to secondary school mathematics.

## References

Davydov, V. (2008). *Problems of developmental instruction: A theoretical and experimental psychological study*. NewYork: Nova Science Publishers.

- Dirichlet, P. G. L., & Dedekind, M. R. (1999). *Lectures on number theory*. (J. Stillwell, Trans.). USA: American Mathematical Society.
- Dörfler, W. (1991). Forms and means of generalization in Mathematics. In A. J. Bishop, S. Mellin-Olsen, & J. V. Dormolen (Eds.), *Mathematical knowledge: its growth through teaching* (pp. 63-85). Dordrecht, Netherlands: Kluwer.
- Dörfler, W. (2008). En route from patterns to algebra: comments and reflections. *ZDM*, 40, 143-160.
- Giusti, E. (1999). *Where numbers come from – Hypothesis about the nature of mathematical objects* [in Japanese]. Tokyo, Japan: Kyoritsu.
- Hayata, T., & Koyama, M. (2013). Generalization, mental object, and stability of import. In A. M. Lindmeier & A. Heinze (Eds.), *Proc. 37<sup>th</sup> Conf. of the Int. Group for the Psychology of Mathematics Education* (Vol. 3, pp. 17-24). Kiel, Germany: PME.
- Howson, G. (2005). "Meaning" and school mathematics. In A. J. Bishop (Ed.), *Meaning in mathematics education* (Vol. 37, pp. 17-38). New York: Springer.
- Ito, S. (1993). *A study on the constructive method in mathematics education part 1* [in Japanese]. Tokyo, Japan: Meijitoshu.
- Iwasaki, H., & Yamaguchi, T. (1997). The cognitive and symbolic analysis of the generalization process: the comparison of algebraic signs with geometric figures. In E. Lehtonen (Ed.), *Proc. 21<sup>st</sup> Conf. of the Int. Group for Psychology of Mathematics Education* (Vol. 3, pp. 105-112). Lathi, Finland: PME.
- Polya, G. (1954). *Mathematics and plausible reasoning: Volume I, Induction and analogy in mathematics*. USA: Princeton University.
- Radford, L. (1996). Some reflections on teaching algebra through generalization. In N. Bernarx, C. Kieran, & L. Lee (Eds.), *Approaches to algebra* (Vol. 18, pp. 107-111). Netherland: Springer.
- Radford, L. (2001). Factual, contextual and symbolic generalizations in algebra. In M. V. D. Hauvel-Panhuizen (Ed.), *Proc. 25<sup>th</sup> Conf. of the Int. Group for the Psychology of Mathematics Education* (Vol. 4, pp. 81-88). Utrecht, Germany: PME.
- Tatsis, B., M., & Tatsis, K. (2012). *Generalization in mathematics at all educational levels*. Rzeszów, Poland: Rzeszów University.
- Tomosada, S., Himeda, K., & Mizoguchi, T. (2006). Aspects of mathematical activity in mathematics learning through generalization or extension and its design [in Japanese]. *Tottori Journal for Research in Mathematics Education*, 9(1), 1-10.
- Ursini, S. (1990). Generalization processes in elementary algebra: Interpretation and symbolization. In G. Booker, P. Cobb, & T. N. Mendicuti (Eds.), *Proc. 21<sup>st</sup> Conf. of the Int. Group for the Psychology of Mathematics Education* (Vol. 2, pp. 149-156). Lahti, Finland: PME.
- Vinner, S. (2011). The role of examples in the learning of mathematics and in everyday thought processes. *ZDM*, 43, 247-256.

# HOW SHOULD STUDENTS REFLECT UPON THEIR OWN ERRORS WITH RESPECT TO FRACTION PROBLEMS?

Tim Heemsoth, Aiso Heinze

Leibniz Institute for Science and Mathematics Education, Kiel, Germany

*Educational research assumes that error reflections are efficient if they include the rationale behind the own error instead of just correcting the error. However, thus far there is a lack of empirical evidence regarding this aspect. Thus, we conducted a field experiment with pre-post-follow-up design and with 7<sup>th</sup> and 8<sup>th</sup> grade students (N = 174). The study was conducted during standard mathematics lessons. We compared two different error-handling strategies. Our findings indicate that students who reflected the rationales behind their errors enhanced their procedural knowledge more than students who reflected on the corresponding correct solution only. Regarding conceptual knowledge we found this effect only at the follow-up-test. The implications for theory and school instructions are discussed.*

## INTRODUCTION

Educational researchers assume error reflections to comprise a high learning potential for the students' learning (e.g. Siegler, 2002; VanLehn, 1999). Yet, most of the previous studies investigated learning from errors committed by someone else (e.g. Große & Renkl, 2007). To our knowledge studies investigating learning from reflections on one's own errors are very rare. Moreover, thus far it is unclear what error-handling strategy supports the students' learning from own errors most efficiently. A core assumption is that students develop more comprehensive cognitive models if the error-handling strategy includes the rationale behind one's own error (Ben-Zeev, 1998). The main objective of the study presented in this contribution is to address these desiderata and to investigate the question whether 7<sup>th</sup> and 8<sup>th</sup> grade students learn fractions better by reflecting on the rationales behind their own errors or by only reflecting on the corresponding correct solution only.

### Student reflections upon errors

If errors occur during the learning process, they have the potential to trigger the reconstruction of the students' concepts and strategies (Duit & Treagust, 2003; Siegler, 2002). Thus far, these concepts and strategies might have been absolutely sufficient to solve previous problem solving situation. However, in the error situation these concepts and strategies need to be reconsidered in order to solve new problem solving situations. Educational research assumes that the corresponding error reflections comprise elaborate learning: It is easy to explain why a correct answer is correct just by citing the given answer. However, explaining why an incorrect answer is incorrect forces the learner to reflect on both the correct solution and its scope of application (Siegler & Chen, 2008). In this study, we assume that an error-handling strategy

supports these elaborate learner's reflections if the strategy builds on the *rationale* behind the error. A rational error occurs if a learner applies a strategy that has worked successfully in a previous problem-solving situation to a new and similar problem that would require another strategy (Ben-Zeev, 1998). For example, students erroneously *overgeneralize* a specific strategy: From addition exercises with two fractions having the same denominator they internalized the rule "numerator plus numerator and denominators remain the same". Some students overgeneralize this rule to multiplication exercises and calculate  $3/9 \times 4/9 = 12/9$  (see Padberg, 2009). Such rational errors indicate a principle misunderstanding. Reflections on these rationales behind the errors can enable the learner to access and adjust his/her insufficient cognitive models (cf. Ben-Zeev, 1998).

### **Previous empirical findings**

Educational research has shown that the integration of errors into the learning process can enhance the students learning (e.g. Große & Renkl, 2007; Keith & Frese, 2005; Siegler, 2002). Yet, in previous studies the role of the rationale behind the error was not investigated systematically. Research on *error management training* highlighted that learners who were encouraged to conduct errors during the learning process improved their task performance more than learners who were instructed to avoid errors (e.g. Keith & Frese, 2005). However, learners who were encouraged to conduct errors were not instructed to reflect on the rationale behind their own error. Instead, research on *learning from incorrect examples* used prompts to trigger learners to reflect why answers were incorrect, to explain the reasoning behind a student's wrong answer or to change the problem so that the student's answer is correct (Große & Renkl, 2007; Heemsoth & Heinze, 2013; Siegler, 2002). In some of these studies learners who were confronted with incorrect examples improved their performance more than learners who were only confronted with correct examples. Yet, some findings indicated that there is an interaction effect regarding the learners' prior knowledge: Learners with high prior knowledge benefited more from incorrect examples while students with low prior knowledge benefited more from correct examples. These findings were found both for university students learning statistics (Große & Renkl, 2007) and for secondary school students learning fractions (Heemsoth & Heinze, 2013). However, even though in these studies students were encouraged to reflect on the rationale behind the error committed by someone else, they did not reflect on their own errors. In one of the few studies that tested instructions on own errors students were instructed to reflect on their own incorrect physics statements by (1) indicating, (2) explaining and (3) correcting their statement (Yerushalmi & Polingher, 2006). A similar error-handling strategy suggests one additional step that asked the students (4) to take action in order to avoid the same error in future problem-solving situations (Guldimann & Zutavern, 1999). In sum, there are indications how to implement an error-handling strategy including the rationale behind students' own errors. However, thus far the effectiveness of these strategies has rarely been investigated. Moreover, since most of the findings described in this section were

derived from strictly controlled experiments with restricted ecological validity, there is a lack of findings with regard to ecologically valid school settings and relevant curriculum topics.

### **The learning topic: Fractions**

In order to investigate our research question we chose fractions as our learning subject. Knowledge of fractions provides a fundamental basis for later algebraic operations, enhances intellectual development and is essential for handling many real-world situations and problems not only occurring during school but during the whole life through (NMAP, 2008) This might be an explanation for why knowledge of fractions has been shown to be a core requirement for mathematical success in later school years (Siegler et al., 2012). Typical student errors have been extensively investigated and many student errors have been shown to be very persistent for the individual student (e.g. Padberg, 2009). In specific, several types of errors can be traced back to a specific rationale. For example these errors result from adopting concepts of natural numbers to fractions (Vamvakoussi & Vosniadou, 2004) or from an overgeneralization of other fraction arithmetic strategies (Padberg, 2009). Thus, fractions seemed to be an adequate domain for our intervention study.

### **The present study**

We examined whether 7<sup>th</sup> and 8<sup>th</sup> grade students improved their knowledge of fractions more if they reflected on the rationale behind their own error (error-centered condition) or if the students were instructed to reflect on a corresponding correct solution only (solution-centered condition). The construction of the error-centered strategy was based on the four metacognitive steps provided by Guldiman and Zutavern (1999). We examined the development of procedural and conceptual knowledge of fractions. We assumed that in the error-centered condition the rationale behind one's own error is included. Thus, students in this condition better adjusted their incorrect cognitive models than students in the solution-centered condition in which the rationale behind one's own error was *not* considered. Moreover, according to Siegler and Chen (2008) we assumed that in the error-centered condition learning was more elaborate. Since elaborate learning is a prerequisite for a successful recall of knowledge (Wittrock, 1989), we assumed the predominance of the error-centered condition to remain stable over time compared to the solution-centered condition. In summary, our research was guided by the following hypotheses:

*Hypotheses 1:* Students in the error-centered condition enhance their procedural knowledge more than students in the solution-centered condition. The effect remains stable after a retention phase.

*Hypotheses 2:* Students in the error-centered condition enhance their conceptual knowledge more than students in the solution-centered condition. The effect remains stable after a retention phase.

## **METHOD**

### **Design**

All students participated in a pre-post-follow-up design. In each class all students were randomly assigned to one of the two the conditions. Before the intervention started we asked for the students' mathematics grade, their gender, and age. During the first two lessons the error-handling strategies were introduced in both conditions. Hereafter, students reflected on their own errors that they conducted either in the pretest (that was conducted after the introduction phase) or in one of two further intermediate tests. The time for reflections on own errors was 135 minutes in total. After the intervention phase a posttest and six weeks later a follow-up test was administered. All tests measured the students' procedural and conceptual knowledge of fractions.

### **Participants**

The sample consisted of 174 students (12 to 15 years of age) who belonged to five 7<sup>th</sup> and four 8<sup>th</sup> grade classes from German secondary schools (Gymnasium or comprehensive school). For all students, the intervention study served as a refresher and opportunity to practice fractions. On the whole, 87 students participated in the error-centered condition and 87 students in the solution-centered condition. There were no group differences regarding mathematics grade, age, gender and number of participants with respect to grade level or school type.

### **Pre-, Post-, Follow-up- and intermediate tests**

We used parallel pre-, post- and follow-up tests to measure procedural and conceptual knowledge of fractions. Example items are presented in Table 1. Seven items emphasized procedural knowledge and asked to use fraction arithmetic procedures to compute a fraction problem. Four conceptual knowledge items comprised basic conceptions of fractions (e.g. part-whole interpretation, see example item in Table 1). To achieve parallel tests, procedural knowledge items differed with regard to numbers and the conceptual knowledge items with regard to the context and numbers. Answers were coded with "1" (correct), "0.5" (partial correct) or "0" (incorrect). Performance scores are represented by the percentage of correct items. The scale reliability for conceptual knowledge at the pretest was low. Thus, findings with regard to conceptual knowledge should be interpreted with caution.

The student reflections were based on the pretest and two more intermediate tests. The intermediate tests were parallel versions of the pre- post- and follow-up-tests. However, due to time restrictions regarding the standard mathematics lessons two shorter versions of the intermediate tests varying in difficulty were administered: Proficiency Level 1 tests only contained two conceptual knowledge items – the two most difficult items were excluded. Proficiency Level 2 tests contained only five procedural knowledge items; the two easiest item types were excluded. Students received Proficiency Level 1 tests if they solved less than 50% of the previous test

problems correctly; they received Proficiency Level 2 tests if more than 50% were solved correctly.

Test	Number of items	Cronbach's alpha			Example Item 1
		Pre	Post	Follow-up	
Procedural knowledge	7	.85	.87	.86	Compute $(\frac{3}{4} * \frac{9}{4}) * 2$
Conceptual knowledge	4	.47	.68	.67	Mr. K. pays a monthly rent of 1500 €. This is $\frac{3}{5}$ of his salary. What is the salary of Mr. K.?

Table 1: Scale reliability and example item for procedural and conceptual knowledge.

### Error-handling strategies

All students reflected on their own errors and used the strategy corresponding to their condition. In the error-centered condition, the students used a worksheet with a table of four rows. The headline of these rows had the following four prompts: (1) Describe your answer and error; (2) Explain, why you thought your answer was correct; (3) Revise your answer; (4) Create a problem in which a similar error could have occurred. Solve this problem correctly. Both the second and the fourth prompt triggered the learners to reflect the rationale behind their errors. In the solution-centered condition, the students worked on examples that corresponded to the exercises that had been solved incorrectly. The examples began with an exercise similar to the exercise the student had solved incorrectly. Below the exercise a correct solution was presented and the students were asked to answer the following three prompts: (1) Describe the student's solution; (2) Explain, why the solution is correct; (3) Revise your answer.

### Procedure

In the first two lessons, the error-handling strategies were introduced in both conditions. Therefore, *non-fraction* problems were presented to the students. During three of the following six lessons, the students took a test of procedural and conceptual knowledge of fractions at the beginning of these lessons (the pretest and the two intermediate tests). Having finished these tests after a short 10-minute break, all students received feedback that was directly presented on the test sheet and indicated right or wrong answers. The students reflected on their own errors using the specific error-handling strategy they had learned before. Reflections were continued in the previous lessons after each test. In total, the reflections lasted 45 minutes each. In the error-centered condition, students who struggled to detect the error were allowed to read a correct example of a similar problem. Examples were the same in the solution-centered condition but were not prompted.

## RESULTS

### Hypothesis 1

To test differences between conditions with respect to procedural knowledge, we used a repeated-measures ANCOVA and entered *condition* as the between-group factor and *time* as the within-group factor. We entered the mathematics grade, gender, age, grade level and school type as covariates to account for possible effects on the students' learning and to estimate results more precisely. There was a significant interaction effect of condition and time on procedural knowledge ( $F(2, 334) = 4.97, p = .008, \eta^2 = .029$ ). Simple effects analyses showed that there was no significant difference at pretest. Yet, the analysis of the post- and follow-up-tests indicated that students in the error-centered condition showed a higher performance both immediately ( $M = 62.32, SD = 33.67$ ) and six weeks after the intervention ( $M = 49.18, SD = 36.13$ ) than students in the solution-centered condition (post:  $M = 54.51, SD = 35.82$ , follow-up:  $M = 43.43, SD = 35.10$ ), post:  $F(1, 167) = 5.99, p = .015, \eta^2 = .035$ , follow-up:  $F(1, 167) = 4.12, p = .044, \eta^2 = .024$  (see Figure 1). Further analyses showed that there were no significant interaction effects between conditions and prior procedural knowledge.

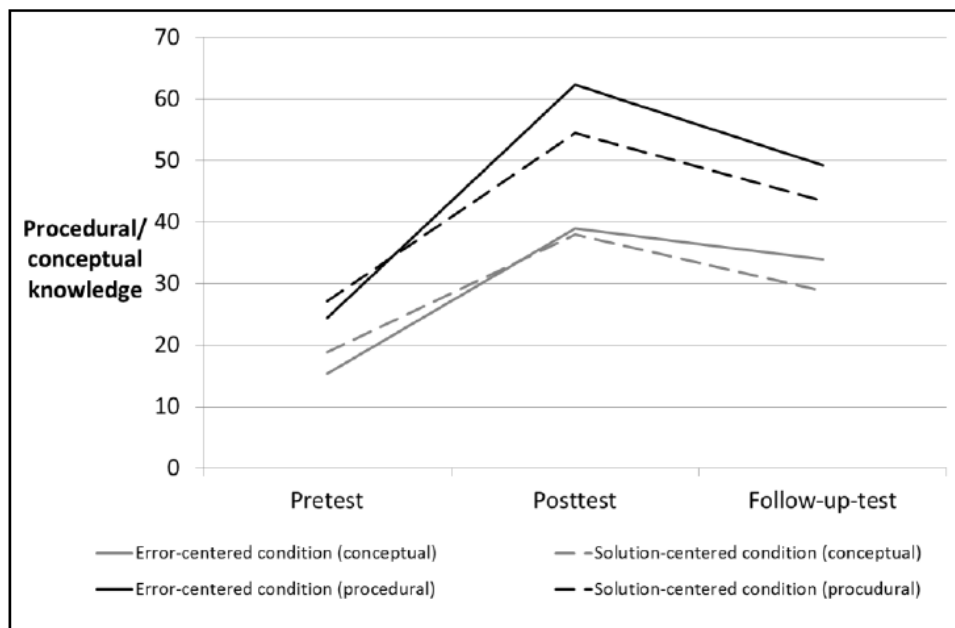

Figure 1: Procedural and conceptual knowledge at pre-, post- and follow-up test, by condition.

### Hypothesis 2

We used a repeated-measures ANCOVA to test for differences between the conditions with respect to conceptual knowledge. We could find a significant interaction effect of condition and time on conceptual knowledge ( $F(2, 334) = 3.26, p = .039, \eta^2 = .019$ ). Simple effects analyses showed that the two conditions neither differed at pretest nor at posttest. However, at the follow-up-test the effect was significant ( $F(1, 167) = 4.02, p = .047, \eta^2 = .023$ ). Students in the error-centered condition had a higher conceptual knowledge ( $M = 33.91, SD = 30.43$ ) than students in the solution-centered condition



( $M = 28.74$ ,  $SD = 32.07$ ). Further analyses showed that there were no significant interaction effects between conditions and prior conceptual knowledge.

## DISCUSSION

In the current study we examined the role of reflections on the rationale behind own errors. In the error-centered condition the students showed a significantly higher performance with respect to procedural knowledge both at posttest and at the follow-up test compared to the students in the solution-centered condition. Regarding conceptual knowledge we could identify a comparable effect only for the follow-up-test. In total we can state that our results support the explanation that instructions on errors are beneficial if they consider the rationale behind one's own errors (Ben-Zeev, 1998). The effect with respect to procedural knowledge is of particular interest because procedural errors were assumed to be very resistant to instructional interventions in some previous research (e.g. Weinert, 1999). The current study might give indications to cope with procedural errors efficiently. An explanation with respect to the retention effect with regard to both knowledge types relies on the idea of more elaborate learning that is triggered by error reflections and that is essential for a recall of knowledge (Siegler & Chen, 2008; Wittrock, 1989). Yet, we must state that to some extent the support is limited to procedural knowledge. For conceptual knowledge the results need to be replicated with more reliable scales. Beyond, the current study indicates that the teachers' fears that reflecting on errors' might confuse students (Heinze & Reiss, 2007) might be not reasonable. Instead, for both mathematics classes and text books our results encourage considering instructions for reflections on the rationale behind own errors.

The current study has some methodological and theoretical limitations that give direction for future research: First, we used parallel knowledge tests. We did not investigate whether reflections on the rationale behind own errors are successful if there are more diverse tasks to-be-learned. Second, we did not assess the quality of error reflections. However, effects of reflections might depend on their appropriateness (Wittrock, 1989). Finally, some students may even have struggled to find the rationale behind their own errors. More specific, there might be errors that are more "treatable" or rather "untreatable" for the students in order to identify the rationale behind the error (see Ferris, 1999).

## References

- Ben-Zeev, T. (1998). Rational errors and the mathematical mind. *Review of General Psychology*, 2, 366-383.
- Duit, R., & Treagust, D. F. (2003). Conceptual change: A powerful framework for improving science teaching and learning. *International Journal of Science Education*, 25, 671-688.
- Ferris, D. (1999). The case for grammar correction in L2 writing classes: A response to Truscott (1996). *Journal of Second Language Writing*, 8, 1-11.

- Große, C. S., & Renkl, A. (2007). Finding and fixing errors in worked examples: Can this foster learning outcomes? *Learning and Instruction, 17*, 612-634.
- Guldimann, T., & Zutavern, M. (1999). "Das passiert uns nicht noch einmal!" - Schülerinnen und Schüler lernen gemeinsam den bewußten Umgang mit Fehlern. In W. Althof & F. Oser (Eds.), *Fehlerwelten. Vom Fehlermachen und Lernen aus Fehlern: Beiträge und Nachträge zu einem Interdisziplinären Symposium aus Anlaß des 60. Geburtstags von Fritz Oser* (pp. 233-258). Opladen: Leske & Budrich.
- Heemsoth, T., & Heinze, A. (2013). Learning fractions from errors. In A. M. Lindmeier & A. Heinze (Eds.), *Proc. 37<sup>th</sup> Conf. of the Int. Group for the Psychology of Mathematics Education* (Vol. 3, pp. 25-32). Kiel, Germany: PME.
- Heinze, A., & Reiss, K. (2007). Mistake-handling strategies in the mathematics classroom: Effects of an in-service teacher training on student's performance in geometry. In J. H. Woo, H. C. Lew, K. S. Park, & D. Y. Seo (Eds.), *Proc. 31<sup>st</sup> Conf. of the Int. Group for the Psychology of Mathematics Education* (pp. 9-16). Seoul, Korea: PME.
- Keith, N., & Frese, M. (2005). Self-regulation in error management training: Emotion control and metacognition as mediators of performance effects. *Journal of Applied Psychology, 90*, 677-691.
- NMAP. (2008). *Foundations for success: The final report of the National Mathematics Advisory Panel*. Washington: US Department of Education.
- Padberg, F. (2009). *Didaktik der Bruchrechnung* (4., erw., stark überarb). Heidelberg: Spektrum, Akad. Verl.
- Siegler, R. S. (2002). Microgenetic studies of self explanations. In N. Granott & J. Parziale (Eds.), *Microdevelopment. Transition processes in development and learning* (pp. 31-58). New York: Cambridge University Press.
- Siegler, R. S., & Chen, Z. (2008). Differentiation and integration: Guiding principles for analyzing cognitive change. *Developmental Science, 11*, 433-448.
- Siegler, R. S., Duncan, G. J., Davis-Kean, P. E., Duckworth, K., Claessens, A., Engel, M., ... Chen, M. (2012). Early predictors of high school mathematics achievement. *Psychological Science, 23*, 691-697.
- Vamvakoussi, X., & Vosniadou, S. (2004). Understanding the structure of the set of rational numbers: A conceptual change approach. *Learning and Instruction, 14*, 453-467.
- VanLehn, K. (1999). Rule-learning events in the acquisition of a complex skill: An evaluation of CASCADE. *The Journal of the Learning Science, 8*, 71-125.
- Weinert, F. E. (1999). Aus Fehlern lernen und Fehler vermeiden lernen. In W. Althof & F. Oser (Eds.), *Fehlerwelten. Vom Fehlermachen und Lernen aus Fehlern: Beiträge und Nachträge zu einem Interdisziplinären Symposium aus Anlaß des 60. Geburtstags von Fritz Oser* (pp. 101-110). Opladen: Leske & Budrich.
- Wittrock, M. C. (1989). Generative processes of comprehension. *Educational Psychologist, 24*, 345-376.
- Yerushalmi, E., & Polingher, C. (2006). Guiding students to learn from mistakes. *Physics Education, 41*, 532-538.

# MATHEMATICS TEACHERS' RECOGNITION OF AN OBLIGATION TO THE DISCIPLINE AND ITS ROLE IN THE JUSTIFICATION OF INSTRUCTIONAL ACTIONS

Patricio Herbst<sup>1</sup>, Justin Dimmel<sup>1</sup>, Ander Erickson<sup>1</sup>, Inah Ko<sup>1</sup>, Karl W. Kosko<sup>2</sup>

<sup>1</sup>University of Michigan<sup>1</sup>, <sup>2</sup>Kent State University

*We describe the conceptualization, development, and piloting of two instruments--a survey and a scenario-based assessment--designed to assess, teachers' recognition of an obligation to the discipline of mathematics and the extent to which teachers justify actions that deviate from what's normative on account of this obligation. We show how we have used classical test theory and item response theory to select items for the instruments and we provide information on their reliability, using a sample of 88 high school mathematics teachers.*

## FOCUS: THE DISCIPLINARY OBLIGATION

This paper reports on efforts to conceptualize and measure teachers' recognition of an obligation to the discipline of mathematics and contributes to an agenda for research that attempts to identify sources of justification for actions in mathematics teaching. This agenda is predicated on the need to have robust ways of predicting how efforts at instructional improvement might fare as they are implemented. The general problem is, given an instructional system located in an institutional context, where, by force of custom, teacher and students are expected to act in ways that are normative, what sources of justification are available for practitioners to use so as to justify, for themselves and colleagues, actions that might depart from the norm?

In their practical rationality framework, Herbst and Chazan (2012) proposed the notion of *professional obligations* as a set of those sources of justification. They identify four obligations --to the discipline of mathematics, to students as individuals, to the class as a social group, and to the institutions where instruction is located (e.g., school, district). This report elaborates on the disciplinary obligation and presents results of our attempts to develop two instruments designed to study it empirically.

## THEORETICAL FRAMEWORK

The problem of why teachers do what they do in classrooms has often been studied using perspectives that consider instructional action as dependent on factors ascribed to the individual teacher (e.g., beliefs, goals, knowledge) and disconnected from considerations of environment (cultural, historical, or institutional; Cooney, 1984;

---

<sup>1</sup> Work done with the support of NSF grant DRL- 0918425 to P. Herbst. All opinions are those of the authors and do not necessarily represent the views of the Foundation.

Schoenfeld, 2010). Often this work has revealed that teachers' perceptions of environmental conditions account for mismatches between what individual teachers might profess to want to do and what they might acknowledge to be able to do in practice (Skott, 2009). Understanding these environmental conditions in which mathematics teachers work is an important terrain for our field still to cover.

Important progress has been made in the last 20 years to conceptualize and study mathematics instruction as an interaction among teacher, content, and students in environments (Cohen et al., 2003). Our field shows plenty of examples of how teacher and students collaboratively shape meanings as they undertake the work of teaching and learning mathematical ideas (Arzarello et al., 2009). Analyses of classrooms as activity systems have helped document the notion that classroom interaction often relies on tacit norms that regulate how teacher and students customarily exchange knowledge (Bauersfeld, 1980; Herbst, 2006).

International studies of mathematics teaching have added attention to the situatedness of instruction in larger systems, in particular national cultures (Stigler & Hiebert, 1999) but one could just as well say historical periods and societal institutions. This scholarship suggest the need to examine in more detail how demands of the environment might affect mathematics instruction, with the hope that this understanding might help explain teachers' instructional actions and decisions.

The discipline of mathematics is an important element in the environment of mathematics instruction in all countries, but it is plausible that it might affect instruction in different ways. In their account of the practical rationality of mathematics teaching, Herbst and Chazan (2012) identify an obligation to the discipline as a source of justification for decisions and actions. They define this obligation in general by saying that "the mathematical knowledge teachers teach needs to be a valid representation of the mathematical knowledge, practices, and applications of the discipline of mathematics" (p. 610). This obligation to the discipline is a reasonable hypothesis that can be traced back to Schwab's (1978) writings on the curriculum or to the heavy investment of mathematicians in the reforms of the 50s and 60s (Kilpatrick, 2012). Research also documents how teachers' views on instructional action, what they consider appropriate or inappropriate to do, are often grounded on disciplinary considerations (Ball, 1993; Lampert, 1990). We could accept as a hypothesis that this obligation affects all teachers of mathematics and still expect this obligation to affect teachers differently. In this paper we offer a conceptualization of those possible differences and we share details of the development of two instruments designed to study those differences.

## **TEACHERS AND THE OBLIGATION TO THE DISCIPLINE**

The discipline of mathematics exercises its role as stakeholder of instruction in various ways. Quite often policy considerations of the state of mathematics education incorporate the views of mathematicians (Becker & Jacob, 2000). Mathematicians are involved in the professional development of teachers and in decisions over the

curriculum for teacher education (see also Wilson, 2003; Ball et al., 2005). Questions can be asked about this influence.

How much and in what ways do teachers recognize an obligation to the discipline? In our earlier analyses of teacher discussions prompted by representations of practice we inspected the rationale that teachers gave for endorsing or opposing actions that deviated from an instructional norm. Among those rationales, participants would make various kinds of references to the discipline: They would draw on the need to show how mathematicians really work, on the need to avoid making unwarranted assumptions, or on the value of writing an elegant proof. The discipline was a salient source of justification, though not the only one (Nachlieli & Herbst, 2009). We undertook a two-pronged approach for the development of research instruments that could help us eventually understand teachers' relationship to the disciplinary obligation. On the one hand we set out to develop a survey that would allow us to gauge the extent to which an individual teacher recognizes an obligation to the discipline. On the other hand we set out to develop a scenario-based questionnaire that would allow us to gauge the extent to which an individual teacher would justify deviating from actions that are normative in instruction on account of an obligation to the discipline. With both instruments our goal was to be able to eventually implement them at scale, so we aimed for final products that could be answered by individuals working on a computer alone and for less than an hour.

### **MEASURING RECOGNITION OF THE DISCIPLINARY OBLIGATION: THE PR-OB-MATH QUESTIONNAIRE**

We have laid out the first steps in investigating recognition of mathematics teachers obligation to the discipline by developing a questionnaire that asks participants to consider statements about mathematics teaching (e.g., "Mathematics teachers do their best to get students to appreciate mathematical elegance") and then asks them to "rate the degree to which mathematics teachers are expected, as professional educators, to act in the manner this statement describes" using a 4-point Likert-type of scale that ranges from (1 = Teachers are always expected to act in this manner to 4 = Teachers are never expected to act in this manner). This instrument, unlike our scenario-based instrument described below, is meant to be used with teachers of mathematics at different levels and nonteachers alike, all of them being asked to indicate their stances toward statements that say what a teacher of mathematics is purportedly expected to do. We developed the survey through several iterations that included brainstorming, item writing, internal and external vetting, piloting with teachers, and examining the collected pilot data using classical test theory (CTT; Crocker & Algina, 1986) and item response theory (IRT; Bond & Fox, 2007).

We started the design process with two versions of the questionnaire, one (ETD, "expected to do") roughly similar to the final one described above and another one (ATS, "appropriateness to say") that included the target statement (e.g., "Mathematics teachers should do their best to get students to appreciate mathematical elegance") in

quotation marks and asked the respondent to rate, using a 6-point Likert-type scale ranging from (1=Very Inappropriate to 6=Very Appropriate), the appropriateness of making such a statement to a fellow mathematics teacher in a teachers' lounge. Following internal review, we vetted our initial set of items through a process of cognitive interviews with secondary mathematics teachers (Karabenick et al., 2007). Initial interviews suggested that teachers did not always interpret the ATS statements as we had intended. Some statements were perceived as inappropriate to say to a colleague but not because of being objectionable actions, but rather because they were too obvious and saying them would insult a colleague's intelligence. We then introduced other contexts where those statements could be made and vetted both the contexts and the statements with additional teachers. These interviews revealed a need to adjust the social context where such disciplinary statements were made (to that of a mentor teacher speaking with a student teacher), assess the validity of items, and revise or discard items. This resulted in a set of 10 items for each ATS and ETD list. We piloted those items with mathematics teachers from a Midwestern U.S. state ( $n = 44$ ) and found them to have low internal consistency ( $\alpha = .49$ ). Efforts to improve reliability via item analysis were not fully successful. In particular we decided to discontinue the ATS items and write more ETD items making sure to anchor statements to emblems of mathematical work that were familiar to teachers. This yielded a list of 26 items.

We piloted the 26 items with a sample of 42 high school mathematics teachers from the Midwest during the Summer of 2013. All statements were rated on a 4-point Likert-type scale in increasing degree of obligation (from 1=Never, to 4=Always). During the piloting of these items we discovered a few difficulties with items, including some modulated (should) statements mixed with descriptive statements, and statements that, along with the rating scale, might yield readings that included double and even triple negatives (e.g., "When introducing a new concept to students, mathematics teachers should not give descriptions that are mathematically imprecise" was not only modulated by "should" but also would become a double negative if participants responded "never"). We rewrote the statements so that they would all be descriptive and that their readings would yield at most one negative (e.g., the statement above became "When teaching students a new property, mathematics teachers ensure that it is described precisely"). This last version of the 26 items was piloted with 46 high school teachers from the Midwest, during the Fall of 2013. Table 1 shows descriptive statistics of the 26 items for both samples.

For the analysis, first, we conducted classical item analysis (looking at the item-total correlations and the changes in alpha coefficient after removal of an item) to remove problematic items among the 26 original items within each of the samples (Summer and Fall 2013). While alpha values (0.756 for Summer and 0.757 for Fall) were acceptable, some items had negative or very low positive item-total correlations. We eliminated 8 items that did not meet a .3 threshold of item-total correlation and as a

result reduced the item set to 18 items. This increased the alpha score of the remaining items to 0.804 and 0.799 for Summer and Fall samples respectively.

We inspected the data set with the goal of running 1-parameter IRT model with the pooled Summer and Fall 2013 samples. Since there had been slight variations in the statement of the items, we inspected first whether the items were functionally equivalent using a DIF analysis on the remaining 18 items. To meet assumptions of DIF and Rasch analysis, we recoded responses from the 4-point scale to dichotomous, using responses 1-2 as 0 and 3-4 as 1. This recoding appeared legitimate given that none of the values of the scale expressed a neutral stance. The DIF analysis showed that 3 of the 18 items functioned very differently in both samples, so we excluded them from the Rasch analysis. (Dorans et al, 1992).

	All 26 items	Selected 13 items
Summer (n=42)	M = 2.96 (.30) $\alpha = 0.76$	M= 3.00 (.40) $\alpha = 0.76$
Fall (n=46)	M = 3.02 (.26) $\alpha = .75$	M= 3.02 (.38) $\alpha = 0.76$

Table 1: Descriptive statistics for items of the PR-OB-MATH instrument

We fit a Rasch model to the pooled samples data for the remaining 15 items and inspected the fit statistics from the Rasch model analyses, excluding 2 more items that, according to Bond and Fox (2007), had poor fit. Thus, the original 26 items could be reduced to 13 items after removing problematic items from iterative item analyses. The selected 13 items were also examined using a Rasch model. The Rasch model with the final selected 13 items shows sufficient item reliability (0.95), but low person reliability (0.52), lower than 0.80 considered acceptable. This means that our items distinguish easier and difficult items well but our items may not be sensitive enough to distinguish between high and low scorers. Table 1 below lists descriptive statistics of our samples with the initial 26 items and the final 13 items.

## THE DISCIPLINARY OBLIGATION'S ROLE IN JUSTIFYING ACTIONS

To investigate the extent to which teachers' recognition of the disciplinary obligation matters in the justification of instructional actions, we developed a scenario-based questionnaire. While the PR-OB-MATH instrument provides a way of assessing the extent to which a mathematics teacher recognizes an obligation to the discipline of mathematics, the role this recognition plays in practical action and decision-making is not apparent: While somebody might recognize an obligation to some extent, the impact of such recognition on action might also depend on practical circumstances such as what they might be expected to do. A *situational judgment test* (Cabrera & Nguyen, 2001) or a scenario-based assessment would give us a chance to explore that question. These assessments have a long history in human resources management, where they are presented as a written vignette or a video. Video-based tests of situational judgment are widely used by personnel departments under the presumption

that a more realistic scenario will result in responses that reflect what candidates will actually do (Weekley & Jones, 2006). Scenarios have also been used to explore teacher decision-making and attitudes for many of the same reasons (Bishop & Whitfield, 1972; Shavelson et al., 1977). Carter et al. (1988) actually presented both novice and expert teachers with slides with visual images from classrooms and used this to compare how experience influenced their descriptions.

To assess the possible impact of recognition of the disciplinary obligation in action, we created items in which the participants view a teaching scenario, represented as a storyboard, and are asked to choose between two courses of action, one considered normative and another that deviates from the former in response to the disciplinary obligation. The introduction to each item would say "In the following slideshow we invite you to consider a scenario in which a high school teacher deviates from a lesson in order to address an issue of mathematical importance. We are interested in the extent to which you think the teacher's action is justifiable." After considering the scenario, participants are asked to indicate "how much you agree or disagree with the following statement:" and given a statement of the form "The teacher should [do what was hypothesized as normative], rather than [do what the teacher had done in the scenario]." To rate their agreement participants are given a 6-point Likert scale ranging from 1 = Strongly Disagree to 6 = Strongly Agree.

We specified 15 such items including scenarios such as providing a definition different than the one given in the textbook, letting a student pursue the consequences of a faulty assumption, modifying the usual format of a task to engage students in a mathematical practice, etc. Because participants had to respond to scenarios that they could relate to, we specified each of the 15 items in general but designed scenarios that adapted that general specification to particularities of instruction in Early elementary (grades K-2), upper elementary (3-5), middle school (6-8), or high school (9-12). (This paper reports high school teachers' data only.) As a rule these scenarios were realized using a set of cartoon characters and the *Depict* software tool that allows us to create storyboards using cartoon characters and speech bubbles. The scenarios were then embedded in a questionnaire created and administered in the LessonSketch platform ([www.lessonsketch.org](http://www.lessonsketch.org)).

After internal review and edition, we convened a focus group including experienced teachers and individuals with strong mathematics background to check whether our hypothesized normative actions were seen as normative by members of the profession and whether the deviations from those normative actions were seen as attending to an obligation to the discipline. After incorporating the group's feedback, the items were piloted with the same groups of high school mathematics teachers described above in Summer 2013 (n=42) and Fall 2013 (n=46). Since items were exactly the same and participants come from the same geographic pool we pooled the samples. In order to fit a 1-parameter IRT model to this data, we recoded responses from a 6-point Likert scale to a dichotomous scale, using responses 1-3 as 0 and 4-6 as 1. The IRT analysis showed good item reliability (.935) and a good range of possible theta scores for participants



(-4.71 to 4.73), indicating that the items, as a set, discriminate between participants that have more or less of the latent trait being measured. In this case, that latent trait is recognition that obligation to the discipline of mathematics can justify actions in a mathematics classroom.

As noted above, while the two instruments, the PR-OB-MATH and the Justifications of Actions scenario-based assessment examine teachers' relationship to the disciplinary obligation, they operationalize different conceptualizations of it and they involve the participants in different activities. It does make sense nevertheless to ask whether and how scores in one instrument are related to scores in the other. We found however no significant correlation between these scores and no significant correlation between either of those scores and years of mathematics teaching experience.

## SIGNIFICANCE AND CONCLUSION

We have made significant progress toward validating two instruments that can help operationalize the notion of professional obligation, which contributes to understanding the rationality behind the work of mathematics teaching. The importance and usefulness of this work goes beyond increasing capacity to describe, explain, and predict instruction; it can also contribute to the development of a professional discourse for mathematics teaching. Indeed, mathematics teachers are professionals but the discourse on which they can justify their actions sits uncomfortably between the individual knowledge and preferences of practitioners and the general discourses of academic disciplines such as mathematics or psychology: The teaching profession can use the development of a shared professional discourse that can better support their practical work. Better understanding how professional obligations impact what teachers deem appropriate to do can help in the long run develop a shared professional discourse of justification.

## References

- Arzarello, F., Paola, D., Robutti, O., & Sabena, C. (2009). Gestures as semiotic resources in the mathematics classroom. *Educational Studies in Mathematics*, 70(2), 97-109.
- Ball, D. L. (1993). With an eye on the mathematical horizon: Dilemmas of teaching elementary school mathematics. *The Elementary School Journal*, 93(4), 373-397.
- Ball, D., Ferrini-Mundy, J., Kilpatrick, J., Milgram, R. J., Schmid, W., & Schaar, R. (2005). Reaching for common ground in K-12 math education. *AMS Notices*, 52(9), 1055-1058.
- Bauersfeld, H. (1980). Hidden dimensions in the so-called reality of a mathematics classroom. *Educational Studies in Mathematics*, 11(1), 23-41.
- Becker, J. P., & Jacob, B. (2000). The politics of California school mathematics: The anti-reform of 1997-99. *Phi Delta Kappan*, 81(7), 529-537.
- Bishop, A. J., & Whitfield, R. C. (1972). *Situations in teaching*. New York: McGraw-Hill.
- Bond, T. G., & Fox, C. M. (2007). *Applying the Rasch model*. London: Psychology Press.
- Cabrera, M., & Nguyen, N. (2001). Situational judgment tests: A review of practice and constructs assessed. *Intl. Journal of Selection and Assessment*, 9(1-2), 103-113.

- Carter, K., Cushing, K., Sabers, D., Stein, P., & Berliner, D. (1988). Expert-novice differences in perceiving and processing visual classroom information. *Journal of Teacher Education*, 39(3), 25-31.
- Cohen, D. K., Raudenbush, S. W., & Ball, D. L. (2003). Resources, instruction, and research. *Educational Evaluation and Policy Analysis*, 25(2), 119-142.
- Cooney, T. J. (1985). A beginning teacher's view of problem solving. *Journal for Research in Mathematics Education*, 16(5), 324-336.
- Crocker, L., & Algina, J. (1986). *Introduction to classical and modern test theory*. NY: Holt.
- Dorans, N. J., Schmitt, A., & Bleistein, C. (1992). The standardization approach to assessing comprehensive differential item functioning. *Journal of Educational Measurement*, 29, 309-319.
- Herbst, P. (2006). Teaching geometry with problems: Negotiating instructional situations and mathematical tasks. *Journal for Research in Mathematics Education*, 37, 313-347.
- Herbst, P., & Chazan, D. (2012). On the instructional triangle and sources of justification for actions in mathematics teaching. *ZDM*, 44(5), 601-612.
- Karabenick, S. A., Woolley, M., Friedel, J., Ammon, B., Blazeski, J., Bonney, C., ... Kelly, K. (2007). Cognitive processing of self-report items in educational research: Do they think what we mean? *Educational Psychologist*, 42(3), 139-151.
- Kilpatrick, J. (2012). The new math as an international phenomenon. *ZDM*, 44(4), 563-571.
- Lampert, M. (1990). When the problem is not the question and the solution is not the answer: Mathematical knowing and teaching. *Amer. Educational Research Journal*, 27(1), 29-63.
- Nachlieli, T., Herbst, P., & González, G. (2009). Seeing a colleague encourage a student to make an assumption while proving. *Journal for Research in Mathematics Education*, 40(4), 427-459.
- Schoenfeld, A. H. (2010). *How we think: A theory of goal-oriented decision making and its educational applications*. New York: Taylor & Francis.
- Schwab, J. J. (1978). Education and the structure of the disciplines. In I. Westbury & N. Wilkof (Eds.), *Science, curriculum, and liberal education* (pp. 229-272). Chicago: University of Chicago Press.
- Shavelson, R. J., Cadwell, J., & Izu, T. (1977). Teachers' sensitivity to the reliability of information in making pedagogical decisions. *Amer. Ed. Research Journal*, 14(2), 83-97.
- Skott, J. (2009). Contextualising the notion of 'belief enactment'. *Journal of Mathematics Teacher Education*, 12(1), 27-46.
- Stigler, J. W., & Hiebert, J. (1999). *The teaching gap*. New York: Free Press.
- Weekley, J. A., & Jones, C. (2006). Video-based situational testing. *Personnel Psychology*, 50(1), 25-49.
- Weiss, M., Herbst, P., & Chen, C. (2009). Teachers' perspectives on "authentic mathematics" and the two-column proof form. *Educational Studies in Mathematics*, 70(3), 275-293.
- Wilson, S. M. (2003). *California dreaming: Reforming mathematics education*. New Haven, CT: Yale.

# FROM KNOWLEDGE AGENTS TO KNOWLEDGE AGENCY

Rina Hershkowitz<sup>1</sup>, Michal Tabach<sup>2</sup>, Chris Rasmussen<sup>3</sup>, Tommy Dreyfus<sup>2</sup>

<sup>1</sup>The Weizmann Institute of Science, <sup>2</sup>Tel Aviv University

<sup>3</sup>San Diego State University

*In this report we further develop the notion of knowledge agent and analyse knowledge agency in an 8<sup>th</sup> grade mathematics classroom learning probability. By knowledge agency we mean the many ways and variations in which knowledge agents act. We also observe the teacher as an orchestrator of the learning process who as such invests efforts to create a learning environment that enables students to be active and become knowledge agents. In our previous work we have identified mainly a single student who acted as knowledge agent. Here we show how four students acted as a group of knowledge agents and that knowledge agency may appear in different forms: as one student and his followers, as two students, and as group of students.*

## INTRODUCTION

For several years now we have been investigating the mechanism of knowledge shifts in mathematics classroom. We combined two approaches/methodologies that are usually carried out separately: The Abstraction in Context approach with the RBC+C model (Dreyfus, Hershkowitz & Schwarz, in press) and the Documenting Collective Activity (DCA) approach with its methodology (Rasmussen & Stephan, 2008). This combination revealed that some students functioned as knowledge agents, where a knowledge agent is a member in the classroom community who initiates an idea, which subsequently is appropriated by other member/s of the classroom community. Knowledge agents are active in shifts of knowledge that are downloaded from the whole class discussion into a group's work or uploaded from a group's work to the whole class discussion, or stayed horizontally within the whole class discourse or the small group discourse. (Hershkowitz, Tabach, Rasmussen & Dreyfus, in press; Tabach, Hershkowitz, Rasmussen & Dreyfus, 2014). We refer the reader to these references for descriptions of the two approaches/methodologies.

In the present research report we focus on empirical examples of knowledge agency in a mathematics classroom learning probability. By knowledge agency we mean the many ways and variations in which knowledge agents act. We also observe the teacher as an orchestrator of the learning process who as such invests efforts to create a learning environment that enables students to be active and become knowledge agents. Thus, our study is aimed at expanding the idea of knowledge agent to knowledge agency based on an empirical bottom up approach.

## THEORETICAL FRAMEWORK

Identifying and understanding the processes governing shifts of knowledge in inquiry mathematics classrooms is a big challenge (Saxe et al., 2009). Hence, questions

regarding the ways that knowledge evolves and moves between and within individuals, groups and the whole class community became very important. These questions are linked to the construct of knowledge agency.

Muller, Yankelewitz & Maher (2012) characterize agency in the classroom in the sense of the interplay of mathematical ideas in the mathematics environment (p. 373). Other researchers take a more explicit stand, where agency is considered mainly as taking the initiative (Pickering, 1995; Wagner 2004), when one or more students create their own mathematical idea or extend an established idea.

Our view regarding knowledge agency in the classroom is longitudinal. It starts from focusing on the student/s who is/are the first to raise a new and relevant mathematical idea when constructing new knowledge. They are knowledge agents for us only if other student/s in the class appropriate this knowledge and use it, that is if knowledge shifts are actualized.

The teacher's role in relation to knowledge shifts, knowledge agents and knowledge agency as a whole in an inquiry classroom is quite delicate. She orchestrates the whole process of learning, but without directly acting as a knowledge agent. Her task is to encourage students to act as knowledge agents within the learning process. Our lens on knowledge agency therefore focuses on this delicate role of the teacher.

## THE STUDY

The data for this study were collected by video recording in an 8<sup>th</sup> grade class engaged in learning probability. The camera was focused either on the whole class discussion or on a focus group. A unit consisting of a sequence of problem situations was carefully designed to offer opportunities for constructing and consolidating knowledge and practices in classroom. The unit included ten lessons.

The present paper focuses on lesson 8 of the unit. During lesson 4, the chance bar as a tool for describing probability in 1-dimensional spaces was introduced and used. Lesson 8, like many of the other lessons, started with a whole class discussion (WCD) followed by small group work, during which we followed the work of a focus group (FG). In the WCD, the teacher initiated a discussion on the *Arrows Problem* (see below), which dealt with a 2 dimensional sample space with un-equal probabilities, represented by a square area model (two orthogonal chance bars).

### The Arrows Problem

Ora and Aya each shoot one arrow aimed at the target.

- a. The probability of Ora hitting the target is 0.3.

Mark this approximately on the chance bar.

- b. The probability of Aya hitting the target is 0.5. Mark this approximately on the chance bar.

- c. Let us draw a square using both chance bars. (The length of the square's side should therefore be 1.) [An empty square was provided.]

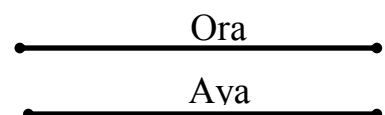

- d. Use your marks on the chance bars to divide the square **approximately** according to the girls' chances of hitting or not hitting the target.
- e. Within each of the four rectangles created, write down what its area expresses.
- f. What is the area of the entire square?
- g. Inside each rectangle, write down its area.
- h. What is the probability of **both girls hitting** the target?
- i. Color a rectangle corresponding to Ora's chances of hitting the target.

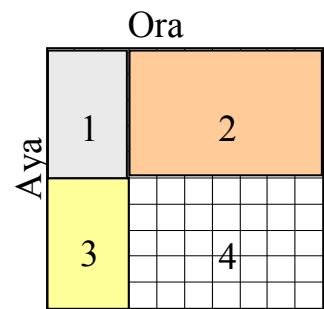

- What is the area of this rectangle?
- j. What is the probability of at least one of them hitting the target? Color the appropriate area.

### A priori analysis of the Arrows Problem

The following Knowledge Elements (KEs) were intended to be constructed while engaging in solving the Arrows Problem.

- Es – Building a square model for the probabilities of a given 2-dimensional sample space problem.
  - Em – Understanding the meaning of a rectangle in the square model as representing the (two dimensional) event.
  - Ep – (event probability) The rectangle measure (area) equals the probability of the event represented by it according to Em.
  - Ec – The whole process can be checked by summing all probabilities to one (100%).
- These KEs have a hierarchical structure. Em cannot be achieved without Es, and Ep cannot be understood without constructing Em. Ec is built on the previous three.

### ANALYSIS AND FINDINGS

The lesson included a WCD, followed by FG work. The WCD was divided into 4 episodes, presented and analysed below. Notation: T – Teacher, S(s) – Student(s).

#### Episode 1: Chance bar for one dimensional sample space (1-7)

- 1 T: We have this: 'Ora and Aya shoot an arrow at a target. ... The probability that Ora will hit the target is 0.3. Mark approximately on the chance bar'. What is the question? What to mark approximately on the chance bar?
- 2 T: Remind me what is there at the ends of the chance bar? Orly, what is there at its ends?
- 3 Orly: 0 and 1
- 4 T: 0 and 1. Now we would like to mark Ora, whose chance to hit the target is 0.3. Would you like to come and mark? You remember the issue of chance bar? [S marks on the chance bar.] He marked the chance; do you think he is correct?

- 5 Ss: Yes!
- 6 T: Good. Now the probability that Aya will hit is 0.5. Where to mark Aya?
- 7 Ss: In the middle!

The teacher reads the problem and encourages the students to be involved (1-2). It seems that the idea of marking the probability of an event on a chance bar, which was introduced in lesson 4, *functions as if shared* in the class (see Hershkowitz et al., in press). The above short episode provides evidence that presenting the probability of a simple event on a chance bar has been consolidated by at least some students.

### Episode 2: Building a square model (8-27)

- 8 T: 0.5 is in the middle. So this is Aya and this is Ora [pointing to chance bars]. Now we will draw a square using the two chance bars. So the length of the side of the square is 1. Why does the length of the square equal 1?
- 9 S: Because this is the length of the chance bar.
- 10 T: Because this is the length of the chance bar. The chance bar was from 0 to 1, right? So we turn one of the lines to build a square from it. I will turn Aya's line and put it here. 'Divide the square approximately according to the chance, the probability of the girls to hit or miss the target'. Does anybody understand what this means? Yes?
- 11 Mike: We divide the square into 4 parts.
- 12 T: Into 4 parts according to the marks. Aya was marked on half, so we will mark it here. Ora we had 0.3, so we mark it here. There, we got 4 regions. Now let us see if we understand what each region means? For example, we have here 4 regions, lets name them: this is region 1, 2, 3, and 4. What does region 1 mean? What does it mean?
- 13 Nitzan: Region 1 is that...[silence]
- 14 T: Is there another region, one whose meaning you know?
- 15 Nitzan: The regions, this is divided to half and this a third.
- 16 T: A bit less than a third, right. What does each region describe? What does region 1 describe, Noam?
- 17 Noam: That Ora and Aya both hit the target.
- 18 T: It says they both hit. Let's see why it says they both hit. Because here from 0 to a half, this part means Aya hits and this that she missed. OK, if you shoot to the target in Aya's case, the chance that it will hit the target is half. And the same that it will not hit, it is also half. So the chance bar divides into: Yes, will hit the target and No, will not hit the target. OK? The same for Ora, only for her the chance to hit the target is smaller, she might be a less good shooter. So the part here says that Ora hit and there is a larger chance that Ora missed. Is this clear?
- 19 Liana: So what is region 3?

- 20 T: What is region 3, good question, who can answer? Who will tell us what is region 3? Yes, Alon.
- 21 Alon: That neither will hit.
- 22 T: 3 says they both miss, this can also happen. What does region 2 say?
- 23 S: That only Ora hit.
- 24 T: This is a region that only Ora hit. What will region 4 say?
- 25 S: That Aya hit.
- 26 T: That only Aya hit. Is it clear what each region means? Is it clear to you?
- 27 Ss: Yes!

The teacher leads a WCD for constructing Es, the idea of the *Square Model*. This episode has a 'procedural flavour', but at the same time the teacher "floods" her students with questions concerning the meaning of the model as a whole and its partial regions in particular. The teacher is aiming at constructing Es and Em. Initially, the meaning of each partial region is not clear to the students, as can be seen from Nitzan (13, 15), a student who already understands the meaning of the chance bar for a one dimensional sample space, but cannot yet combine two chance bars together to create a meaningful sample space in two dimensions. Various students contribute to the construction of the meaning of the rectangles: Noam (17), Alon (21) and two additional students (23, 25). As a group, these four students potentially act as *knowledge agents* by providing their fellow students an opportunity to share with them the knowledge element Em. We say potentially as we do not yet have evidence that other students followed them. Liana in 19 shows interest in the meaning of region 3, and perhaps she is the first "follower".

The way the teacher is orchestrating the discussion is similar to what van Zee and Minstrell (1997) characterized as tossing, meaning that she takes students' questions and "tosses" them back to the class (e.g., 19-20). By doing so, she is moving the responsibility of meaning making and hence learning back to her students.

### Episode 3: Building Ep (28 – 61)

- 28 T: OK. Now how do I know, I am looking at question h. 'What is the probability that both hit the target?' Both hit. Which rectangle is it?
- 29 Ss: Rectangle 1.
- 30 T: Rectangle 1. How from this, from this drawing can I answer the question: 'What is the probability they both hit the target'? Adi?
- 31 Adi: I think that...
- 32 T: I prefer that you will tell me a computation and not a result, by the way.
- 33 Adi: Ah...
- 34 T: Does this help you?
- 35 Adi: No.
- 36 T: No. Ayelet?

- 37 Ayelet: To calculate the area of the rectangle.
- 38 T: Ayelet says that she would like to know the area of this rectangle, in which they both hit. How can we find the area of this rectangle?
- 39 Ss: Side times side.
- 40 T: Side times side, what is the length of this side? Half. The event they both hit will be half times what?
- ...  
47 Guy: In fact the area that only Ora hit is also 15%, because these are the same measures, 0.5 and 0.3.
- 48 T: OK, you say, only Ora hit, it is easy to calculate because accidentally, as Aya has 0.5 chance to hit, at the same time she has 0.5 to miss. The calculation is the same calculation, so I need to calculate something which I already know the answer to. And if we would like to calculate others, how are we going to do it?
- ...  
56 T: Can someone say without calculating or with calculating in a different way what will be here? [Points to the area that was not yet computed].
- 57 Itamar: Both miss?
- 58 T: Yes, both miss
- 59 Itamar: Also 35%.
- 60 T: Because?
- 61 Itamar: Because it is the same size.

Here the episode continues with the teacher leading the emergence of Ep (identifying the measure of each partial area with the probability of the event it represents). The discussion unfolds so that first the meaning is constructed (37-40), and then the procedural knowledge of computing the areas (not presented). The teacher was well aware of students' lack of procedural knowledge regarding multiplication of decimal numbers. She also represented the area by percentages, perhaps trying to create an additional scaffold for some students.

The discussion between Guy and the teacher (46-47) provides evidence that Guy constructed Em and Ep. It also provides evidence that other students acted as knowledge agents concerning Em and Ep. At the same time, he is the first student to express the meaning of the links between the two knowledge elements.

The discussion regarding the probability of each of the events is at a procedural level. Also, the calculation of the probability of each event is done more efficiently and quickly than the previous one. Specifically, Itamar provides evidence for both knowledge elements – Em and Ep.

#### **Episode 4: critical thinking, control (62- 66)**

- 62 T: Right, because it is the same size. Now how can we check that we don't have a mistake?
- 63 Yael:  $15\% + 15\% + 35\% + 35\% = 100\%$



- 64 T: Why does it have to be 100% when adding all these?
- 65 Itamar: Because 100% is the whole.
- 66 T: Because this is the whole, and here we describe all 4 cases that can happen when two people each shot an arrow. Do you understand this task? Including those who did not understand it before?

Here the teacher initiates critical thinking, in order to check the correctness of the probability calculations done. Yael (63) provides data (the probability of each of the four events) and a claim (the sum of the probabilities is equal to 100%). Itamar (65) provides the warrant. In this episode, Yael functions as knowledge agent and Itamar follows her by completing the argument. Together they act as potential knowledge agents for Ec. We do not have any evidence that Yael and Itamar have followers, nor that anyone objects to this argument.

During the following FG discussion, Yael, Noam and Rachel worked on similar problems. In their discussion we have identified traces of knowledge agency, that is their discussion included elements from the WCD.

## DISCUSSION

Our study aimed at expanding the idea of knowledge agent to knowledge agency based on an empirical bottom up approach. The combined (RBC and DCA) analytic approach allowed us to document the evolution and the shifts of mathematical ideas in the classroom, and the main roles individuals play in these processes. As defined above, a knowledge agent is a student who, according to researcher observations, first initiates an idea within one classroom setting, which later is appropriated by others in the same or another classroom setting. This means that in addition to the students who act as knowledge agents, there are students who are qualified enough or have adequate ability to be inspired by the new idea and to appropriate it. We call the raising of a new idea and its appropriation by another student a *shift of knowledge*.

In our previous work we have identified mainly single students who acted as knowledge agents. Here, in Episode 2, we have four students who acted as a group of knowledge agents, together putting forward Em (the meaning of each rectangular part of the square model). In Episode 3, we have evidence (29) that other students followed this idea, hence we can say that the four students acted as knowledge agents. We can see that knowledge agency may appear in different forms: as one student and his followers, as two students (Hershkowitz et al., in press), and as a group of students. Later on in this lesson during FG work we have evidence of additional followers. All the above evidence shows mechanisms of knowledge agency in the classroom, which initiates knowledge shifts in the class.

The role of the teacher in any classroom includes responsibility for the knowledge learned. In an inquiry classroom, this responsibility is expressed in an indirect way, meaning that the teacher's task is to create a learning environment in which knowledge agency may flourish. The teacher in this lesson created such an environment by the tasks and by the way she orchestrated the whole class discussion and the lesson as a

whole. Particularly, in this lesson the knowledge includes procedural processes concerning the use of the area model for calculating the probabilities of two dimensional sample space events. She also succeeded to include critical thinking (Episode 4), and encouraged knowledge agency (episodes 2-3-4).

In the future, we intend to further elaborate on knowledge agency and knowledge shifts in inquiry classrooms, as well as on the role of the teacher in building and sustaining a learning environment in which knowledge agency and knowledge shifts are a powerful and integral part of the learning activity.

### **Acknowledgment**

This study was partially supported by the Israel Science Foundation under grant number 1057/12.

### **References**

- Dreyfus, T., Hershkowitz, R., & Schwarz, B. B. (in press). The nested epistemic actions model for abstraction in context – theory as methodological tool and methodological tool as theory. In A. Bikner-Ahsbals, C. Knipping, & N. Presmeg (Eds.), *Doing (qualitative) research: Methodology and methods in mathematics education*. New York: Springer.
- Hershkowitz, R., Tabach, M., Rasmussen, C., & Dreyfus, T. (in press). Knowledge shifts in a probability classroom – A case study involving coordinating two methodologies. *ZDM – The International Journal on Mathematics Education*.
- Muller, M., Yankelewitz, D., & Maher, C. (2012). A framework for analysing the collaborative construction of arguments and its interplay with agency. *Educational Studies in Mathematics*, 80, 369-387.
- Pickering, A. (1995). *The mangle of practice: time, agency, and science*. Chicago: University of Chicago Press.
- Rasmussen, C., & Stephan, M. (2008). A methodology for documenting collective activity. In A. E. Kelly, R. A. Lesh, & J. Y. Baek (Eds.), *Handbook of innovative design research in science, technology, engineering, mathematics (STEM) education* (pp. 195-215). Oxford: Taylor and Francis.
- Saxe, G. B., Gearhart, M., Shaughnessy, M., Earnest, D., Cremer, S., Sitabkhan, ... Young, A. (2009). A methodological framework and empirical techniques for studying the travel of ideas in classroom communities. In B. B. Schwarz, T. Dreyfus, & R. Hershkowitz (Eds.), *Transformation of knowledge through classroom interaction* (pp. 203-222). London, UK: Routledge.
- Tabach, M., Hershkowitz, R., Rasmussen, C., & Dreyfus, T. (2014). Knowledge shifts in the classroom – A case study. *Journal of Mathematics Behavior*, 33, 192-208.
- van Zee, E., & Minstrell, J. (1997). Using questioning to guide student thinking. *Journal of the Learning Sciences*, 6, 227-269.
- Wagner, D. (2004). Critical awareness of voice in mathematics classroom discourse: Learning the steps in the “dance of agency”. In M. J. Høines & A. B. Fuglestad (Eds.), *Proc. 28<sup>th</sup> Conf. of the Int. Group for the Psychology of Mathematics Education* (Vol. 4, pp. 401-408). Bergen, Norway: PME.

# THE SPACE BETWEEN THE UNKNOWN AND A VARIABLE

Dave Hewitt

School of Education, University of Birmingham

*The meaning given to letters is significant for students' ability to be successful with algebraic tasks. Recent studies have noted that even when students have a sense of generalised number, they often have a natural number bias in the values they think a letter can take. This study analyses interviews from 13 students across two schools to explore the meaning they had for letters. The responses supported the idea that some students have a natural number bias and also that the notion of a letter representing a fraction is problematic. In addition, three other factors emerged which affected the meaning given to a letter: what was mentally stressed; the desire to avoid "messy" calculations; and viewing an equation as an example of a wider class of equations.*

## BACKGROUND

Several studies have identified difficulties students have with algebra (Herscovics, 1989; Kieran, 1981; Küchemann, 1981). These difficulties relate to a number of factors, including the way in which the equals sign is viewed (Sáenz-Ludlow & Walgamuth, 1998), the need to view an expression both as a process to carry out and as an object in its own right (Sfard, 1991) and the parsing of expressions (Gunnatsson, Hernell, & Sönnnerhed, 2012; MacGregor & Stacey, 1997). Another difficulty centres on the meaning given to a letter within an expression. Küchemann's (1981) seminal research identified a hierarchy of six ways in which letters were used by students: *Letter evaluated*, *Letter not used*, *Letter as object*, *Letter as specific unknown*, *Letter as generalised number*, and *Letter as variable*. A good understanding of the concept of a variable can be core to future success within complex algebraic problems (Trigueros, Ursini, & Escandón, 2012), so students' understanding of letters, or literal symbols, is significant.

The meaning placed given to a literal symbol has changed over time within the history of mathematics (Usiskin, 1988). Ely and Adams (2012) and Christou and Vosniadou (2012) suggest that initially literal symbols only stood for natural numbers and only later was their meaning widened to become the symbolic world of real numbers. Usiskin (1988) suggests that not only has the meaning of a literal symbol changed over the course of history but that it can change according to your conception of what algebra really is.

Recent studies have shown that many students have a natural number bias when considering which numbers a letter might represent (Christou & Vosniadou, 2012; Vamvakoussi, Van Dooren, & Verschaffel, 2012). This suggests a complex journey between having a sense of, in Küchemann's (1981) terms, letter as generalised number and letter as variable.

## THE STUDY

This study looked at the meaning students gave to algebraic expressions and equations, including the letters which appeared in them. In all 13 students were interviewed, aged between 12-13 years old, from two non-selective secondary schools in the UK (six from an all-girls school, S1, and seven from a mixed sex school, S2). The questions consisted of presenting students with an expression or an equation and asking them to describe what this meant. With some questions the focus was on the meaning of the letter, or letters, which appeared in that expression or equation. Students were not explicitly asked to solve equations as this might have influenced the meaning they gave for a letter. The questions were presented in two different contexts: the first was simply on a piece of paper, and the second was within a computer environment called *Grid Algebra* which had been used in both schools. Similar questions were presented in each of these environments at different points within the interview. Except for two occasions, there were no differences between the responses students gave to the paper environment compared with the computer environment and as a consequence this is not discussed further in this paper (more detail about the software can be found in Hewitt, 2012). The style of the interviews was semi-structured in that all students were presented with the same questions with additional questions used as appropriate to probe further into the meanings they had. A framework for the interview questions was influenced by Knuth et al. (2005) where an expression or equation was presented and students asked for the meaning they gave to the letter. Follow up questions were guided by the literature on natural number bias (Christou & Vosniadou, 2012) where they had asked students to indicate numbers which could be substituted for a letter. In my case I changed this and offered specific numbers: one larger natural number, one negative number, one decimal and one fraction. In addition, I also presented some expressions and equations and asked what the expression/equation meant. This was to gauge what sense they had of the expression as a whole, whether they interpreted the order of operations correctly and see whether, in the case of equations, they would naturally try to solve the equation without a prompt. Although not the focus of this paper, in general their understanding of order of operations was good.

The interviews lasted between 20-30 minutes and were audio recorded. They were all transcribed and initial analysis was carried out on whether there were significant differences between the responses to similar questions within the two environments. This was to see whether learning had remained context dependant or whether students were able to transfer their learning from the computer environment to the traditional paper environment. As reported above, students invariably responded in a similar way to both environments. Additional analysis was then carried out with a Grounded Theory approach (Strauss & Corbin, 1990) focused on the meanings students gave to the letters involved in expressions and equations. More emphasis was given in the analysis to this than whether their arithmetic, for example, was accurate or not. Thus if they showed an awareness that they needed to carry out inverse operations to solve an equation, and that this meant the letter represented one particular value, then this was

considered to be of more interest than whether they did the inverse operations in the correct order or whether they made an arithmetic error. Indeed, at times during the interview I offered to be a human calculator for the odd student who was struggling with arithmetic calculations. Throughout this analysis, a number of themes developed and sections of the transcripts were coded accordingly.

## RESULTS

Some students showed a clear difference between their meaning of a letter within an expression, such as  $4x+2$ , and an equation such as  $2(x+3)=14$ . For example, Joanna (S1, pseudonyms used for all students) said in relation to the expression that “it [ $x$ ] can mean any number in the world. It’s kind of the substitution for a number and you can put any number and replace  $x$ ”. In relation to the equation above, she said, after solving the equation, that “ $x$  has to be four because if you put any other number in then it wouldn’t equal 14.” Sharon (S1) also talked about this same equation and when asked whether  $x$  could be any number she said “Yeah, as long as it makes 14” and thought that there could be two or three ways of making 14. She showed awareness that the equation is essentially a statement which says that these calculations have to equal 14. It is another awareness altogether that with such a linear equation there would only be one such value which would achieve this. She still had a sense that  $x$  stood for a determined value or values, and that there was not free choice as to the value  $x$  could take.

Sylvia (S2) said the following when talking about the expression  $4x+2$ : “It means any number, for an equation, for anything. Like if you don’t know what you’ve got, how much a specific number is, you put a letter for it”. In her case the language shifts from “*any number*” to a “*specific number*”. Her use of the word “*equation*” also raised questions about how she was viewing this expression. With another student, Myra (S1), she was quite unsure whether  $x$  could take any other value than three in the equation  $4x+2=14$ , saying “I’m not sure. I don’t think so. I’m not sure, I don’t think so. Well it could be something like...no, I’m not sure. I don’t know.”

The interviews revealed some interesting thinking with regard to how a letter was viewed and three themes emerged: *What does ‘any number’ mean?*; *Seeing a class of possible equations*; and *Temporal viewpoints*.

### What does ‘any number’ mean?

Chris (S2) felt that  $x$  could be any number with the expression  $2(x+3)$ . However, I continued by asking him whether it could be 562 and he replied “no”. Upon further questioning it appeared that he felt this was too big a number.

Matt (S2) talked about the meaning of  $f$  in  $2\left(\frac{f-6}{2}+2\right)$  and said “ $f$  is like any number.

So, it could be like 1, 2, 3 or 4, 5.” This list was a list of natural numbers and it could have been just a convenient list to offer as examples or it could have been more about him feeling that  $f$  had to be a natural number. This issue appeared in other expressions

put in front of him where he would start off saying that the letter could be any number but end up restricting the possibilities to natural numbers. For example, with  $4x + 2$  he said initially that  $x$  could be any number. However, when asked whether it could be 532 he said “Probably yeah. But it’ll be an odd question.” He was uncertain whether it could be negative five and felt it couldn’t be 1.8. He ended up feeling that it had to be a “whole number”. This was the case when he considered  $\frac{3(n+2)}{6} - 1$  as well,  $n$  had to be a whole number.

Myra (S1) started off saying  $x$  could be “any number... it’s just any sort of random number” when talking about  $4x + 2$ . However, she then continued to say that it had to be an even number “because it doesn’t really work as well with odd numbers. It’s got to be even.” Her reason for this was because it was easier to divide and times by even numbers than by odd numbers. This sense of something becoming more difficult or ‘messy’ influenced some of the thinking as to what value a letter could take. So, although eventually agreeing that 2.8 could work she talked about it not working “as well as” other numbers because it was a decimal.

Sharon (S1) felt that although the letters in  $k\left(\frac{4}{t} + 6\right) - p$  can take different values “it has to like make sense, if it doesn’t it’s just going to be wrong.” So this, in his view, restricted the values to not allowing “weird” [his word] numbers.

With expressions, where the letter represented a variable, the letter taking on the value of *a half* seemed to be particularly problematic for seven of the 13 students interviewed. For most of these seven, they were quite happy that a letter could be 562 or -5 or even 1.8. However, a half was another matter. Four students said “no” immediately and the other three students hesitated before replying or indicated that they were uncertain. For example, Sarah (S2) was quite happy that  $x$  in  $4x + 2$  could be 562, -5 or 1.8 but when asked about a half she said “probably”. When asked whether that meant probably yes or probably no, she said “no”.

Abigail (S2) also felt that  $x$  could not be a half in  $2(x + 3)$  “because that’s put as a like one dash two instead, but if it was half of like in numbers” then it would be fine. The notational form of a half as  $\frac{1}{2}$  seemed to be problematic as opposed to the decimal form of 0.5. Even one the students, Romana (S1), who responded positively quite quickly to the possibility of the letter being a half, still re-phrased my wording of “a half” when agreeing: “point five, yeah”.

### Seeing a class of possible equations

With some of the interview questions, I presented an expression, such as  $2(x + 3)$ , asking them about what the letter  $x$  means, followed by the same expression but with it equal to a numerical value, such as  $2(x + 3) = 14$ . Some of the students’ responses to

the equation indicated that they were taking this equation as just an example of equations in general, rather than treating this as a particular case. Matt (S2) felt that the situation regarding what  $x$  meant had not changed going from the expression to the equation “because  $x$  plus 3 would be  $x$  plus 3 and then you do  $x$  times 2. So, yeah it’d be the same but the answer would just be different.” Although his statement about the operations was not quite correct, the relevant point here was that he was seeing that  $x$  could still be any number, it was just that the 14 at the end would have to be a different number. So, he saw the 14 as an example of ‘an answer’ rather than it being a particular requirement that  $2(x + 3)$  *must* be 14. Sarah (S2) also seemed to be thinking the same when she responded to being asked whether  $x$  could be 562. She said “it depends” and on further questioning it became clear that it depended upon what number was placed after the equals sign.

Myra (S1) seemed to consider keeping the ‘answer’ of 14 the same with  $4x + 2 = 14$  but explored changing the operations carried out on  $x$  in order that  $x$  could take on different values whilst still ending up with 14. She started off saying that  $x$  had to be three but then decided it could be a different number completely if you could work out the operations to make it equal 14 in the end. She felt that “if you worked it out hard enough then I suppose you could do it [make  $x$  have a different value]”.

### Temporal viewpoints

One student, Rebecca (S1), considered which values  $x$  could take with the equation  $2(x + 3) = 14$ . After much discussion about what  $x$  could stand for, Rebecca gave a clear articulation which summed up her thoughts: “When you look at it, it’s like, it could be any number. You don’t know, you can guess. And then when you work it out it would be one certain number.” Here she gave me a sense that her answer to my question would change according to her state of mind at that particular moment in time. Initially, it could be any number as she had not started working it out yet. However, once it had been worked out, it was one particular number.

## DISCUSSION

There were a few students who felt that the letter within an expression could stand for “any number” and so appeared to have a sense of generalised number (Küchemann, 1981) but then revealed that by “any number” they meant natural numbers. This fits in with the natural number bias identified by Christou and Vosniadou (2012) and Vamvakoussi et al. (2012). However, students also talked about not including certain numbers due it becoming “messy” or “not working so well”. This seemed to indicate that it was not only a matter of the letter itself being a natural number but that, whichever value the letter took, the ensuing calculations should involve only natural numbers. This led to more restrictive domains for the possible values of the letter. For example, Myra wanted the letter not to be an odd number as division was involved and she felt division was “easier” with even numbers.

Many of the students felt that the letter could not represent  $\frac{1}{2}$  but some felt that it could represent 0.5. This raised the issue of how they viewed fractions. Stafylidou and Vosniadou (2004) point out that the development of students' concept of fraction is different to that for natural numbers due to its particular notation. Students have difficulty relating the two numbers involved with the numerator and denominator and as such they "think of fractions as pairs of whole numbers and not as single numbers" (Christou & Vosniadou, 2012, p. 515). This might account for why the students rejected "a half" as a possible value for  $x$  since they might have viewed the fractional form of a half as not a single number.

Three of the students saw a particular equation as a representation of a class of equations, where either "the answer" (the number to the right of the equals sign in these cases) could be changed, or the operations carried out on the letter could be changed. By considering a class of equations they felt that  $x$  could take on different values.

Lastly, Rebecca's response to  $2(x+3)=14$  gave a sense of her state of mind at particular moments in time. On first seeing the equation, perhaps before taking on board the particular numbers and operations involved, she had an initial feeling that she did not know what the letter was. So, at that moment in time,  $x$  could be anything. There was a sense of the *potential* held within the letter  $x$ . However, at a later point in time, when she had been able to note the particular operations involved, she was able to establish the particular value of the letter. As a consequence the potential ("any number") shifts into the actual ("a particular number"). Bardini et al. (2005, p. 129, their emphasis) commented that for some students "it [a variable] is merely a *temporally indeterminate number* whose fate is to become determinate at a certain point." My understanding of this comment is that more information may be provided in the future which will determine the value of a letter. However, in Rebecca's case it was not a matter of more information arriving but that she shifted her attention onto parts of the information which was already currently available (i.e. the particular operations). Thus the shift from *temporally indeterminate number* to *determinate* was one which reflected her thoughts at particular moments in time and was determined by what she chose to stress at that moment.

The responses here not only support some earlier studies regarding natural number bias and the reluctance to consider fractions, but also offer three other ways in which students' thinking can affect the way letters are viewed in the space between unknown and variable. These are: firstly, how the meaning for a letter can be a temporal matter reflecting a state of mind at a particular point in time; secondly, how the wish to avoid "messy" calculations can restrict the domain even further than that of natural numbers; and thirdly, the meaning for a letter can be affected by seeing an equation as an example of a wider class of equations where the role of a particular letter is considered across the class rather than purely within the particular equation in view.



## References

- Bardini, C., Radford, L., & Sabena, C. (2005). Struggling with variables, parameters, and indeterminate objects or how to go insane in mathematics. In H. L. Chick & J. L. Vincent (Eds.), *Proc. 29<sup>th</sup> Conf. of the Int. Group for the Psychology of Mathematics Education* (Vol. 2, 129-136). Melbourne, Australia: PME.
- Christou, K. P., & Vosniadou, S. (2012). What kinds of numbers do students assign to literal symbols? Aspects of the transition from arithmetic to algebra. *Mathematical Thinking and Learning, 14*, 1-27.
- Ely, R., & Adams, A. E. (2012). Unknown, placeholder, or variable: What is x? *Mathematics Education Research Journal, 24*(1), 19-38.
- Gunnatsson, R., Hernell, B., & Sönnnerhed, W. W. (2012). Useless brackets in arithmetic expressions with mixed operations. In T.-Y. Tso (Ed.), *Proc. 36<sup>th</sup> Conf. of the Int. Group for the Psychology of Mathematics Education* (Vol. 2, 275-282). Taipei, Taiwan: PME.
- Herscovics, N. (1989). Cognitive obstacles encountered in the learning of algebra. In S. Wagner & C. Kieran (Eds.), *Research issues in the learning and teaching of algebra* (pp. 60-86). Reston, Virginia: National Council of Teachers of Mathematics.
- Hewitt, D. (2012). Young students learning formal algebraic notation and solving linear equations: are commonly experienced difficulties avoidable? *Educational Studies in Mathematics, 81*(2), 139-159. doi: 10.1007/s10649-012-9394-x
- Kieran, C. (1981). Concepts associated with the equality symbol. *Educational Studies in Mathematics, 12*(3), 317-326.
- Knuth, E. J., Alibali, M. W., McNeil, N. M., Weinberg, A., & Stephens, A. C. (2005). Middle school students' understanding of core algebraic concepts: equivalence & variable. *ZDM, 37*(1), 68-76.
- Küchemann, D. (1981). Algebra. In K. M. Hart (Ed.), *Children's understanding of mathematics: 11-16* (pp. 102-119). London: John Murray.
- MacGregor, M., & Stacey, K. (1997). Students' understanding of algebraic notation: 11-15. *Educational Studies in Mathematics, 33*, 1-19.
- Sáenz-Ludlow, A., & Walgamuth, C. (1998). Third graders' interpretations of equality and the equal symbol. *Educational Studies in Mathematics, 35*, 153-187.
- Sfard, A. (1991). On the dual nature of mathematical conceptions: reflections on processes and objects as different sides of the same coin. *Educational Studies in Mathematics, 22*(1), 1-36.
- Stafylidou, S., & Vosniadou, S. (2004). The development of students' understanding of the numerical value of fractions. *Learning and Instruction, 14*, 503-518.
- Strauss, A., & Corbin, J. (1990). *Basics of qualitative research: Grounded Theory procedures and techniques*. London: SAGE publications Ltd.
- Trigueros, M., Ursini, S., & Escandón, C. (2012). Aspects that play an important role in the solution of complex algebraic problems. In T.-Y. Tso (Ed.), *Proc. 36<sup>th</sup> Conf. of the Int.*

*Group for the Psychology of Mathematics Education* (Vol. 4, 147-153). Taipei, Taiwan: PME.

Usiskin, Z. (1988). Conceptions of school algebra and uses of variables. In A. F. Coxford & A. P. Shulte (Eds.), *The ideas of algebra, K-12* (pp. 8-19). Reston, Virginia: NCTM.

Vamvakoussi, X., Van Dooren, W., & Verschaffel, L. (2012). Naturally biased? In search for reaction time evidence for a natural number bias in adults. *Journal of Mathematical Behavior*, 31, 344-355.

# STUDENTS' UNDERSTANDING OF SQUARE NUMBERS AND SQUARE ROOTS

Erica J. A. Hiebert

Simon Fraser University & Surrey School District SD36

*Despite their apparent simplicity, the concepts of square numbers and square roots are problematic for high school students. I inquired into students' understanding of these concepts, focusing on obstacles that students face while attempting to solve square number problems. The study followed a modified analytic induction methodology that included a written questionnaire administered to 51 grade 11 students and follow up clinical interviews with 9 students. The study revealed significant obstacles relating to the representation of square numbers and confusion of concepts including both weak distinction between the concepts of square numbers and square roots and inconsistent evoking of their concept images.*

## INTRODUCTION AND FOCUS

Some mathematical concepts appear too simple to cause confusion for students. These concepts are taught as if to understand them only requires being informed of their pertinent properties and from then on no confusion should be possible. Square numbers are such a concept. What could be simpler than arranging dots into a square shape? And yet students do have a variety of ways of comprehending square numbers, and square numbers are not quite as simple as might appear at first glance.

In this study I investigate the research question: “What obstacles do students encounter when attempting to solve problems with square numbers and square roots? In particular to what degree does: confusion of concepts, and representation of square numbers and square roots, hamper students attempting to solve problems?”

Research that focuses on students' learning and understanding of ‘simple’ square numbers and square roots is slim. However, Gough (2007) does discuss the difficulties of teaching square roots and argues that in the case of square roots, the vocabulary can be confusing and detrimental to student understanding. ‘Square number’ and ‘square root’ are similar sounding phrases that evoke images from our everyday English language use of those words and while ‘square number’ *may* yield a useful image, ‘square root’ does not convey much meaning in and of itself. These two phrases are very similar and may hinder students when they are attempting to distinguish between the two. The role of definitions has not been studied with particular respect to square numbers or square roots, but the similarity of the terms square number and square root may be an obstacle for students.

## **THEORETICAL FRAMEWORK**

The data analysis was performed through the lens of the theoretical constructs of concept image and concept definition, and opaque and transparent representation. Each construct is described in general and with particular emphasis on square numbers and square roots.

### **Concept Image and Concept Definition**

Tall and Vinner (1981) were the first to describe concept image and concept definition using these terms; they describe concept image as “the total cognitive structure that is associated with the concept, which includes all the mental pictures and associated properties and processes. It is built up over the years through experiences of all kinds, changing as the individual meets new stimuli and matures” (p. 152). They also describe concept definition as “a form of words used to specify that concept. It may be learnt by an individual in a rote fashion or more meaningfully learnt and related to a greater or lesser degree to the concept as a whole” (p. 152). As an individual’s concept image is built up of many parts and is developed through experience, some portions of the concept image may be incorrect or incomplete, and may conflict with that person’s concept definition.

I looked for examples of students demonstrating a robust and multi-dimensional concept image and examples of students demonstrating a shallow concept image of square numbers and square roots. Examples of incomplete concept images of square numbers include statements that ‘anything squared’ is a square number or that ‘perfect cubes cannot be perfect squares’. A more complete concept image would correctly limit the domain to integers as ‘an integer times itself’.

### **Opaque and Transparent Representation**

A number may be represented in numerous ways. Representations may be referred to as opaque or transparent; representations that highlight a desired property of a number may be said to be transparent to that property, while representations that obscure a property are said to be opaque to that property (Lesh, Behr & Post, 1999). Zazkis and Gadowsky (2001) assert that all representations are opaque to some features and transparent to others. With respect to square numbers and square roots, the representation of an expression may be more or less opaque to the feature of ‘squareness’.  $64^2$  is an example of an expression that is transparent with respect to squareness. Here the exponent ‘2’ clearly shows that this number is a square number based on the definition and common description of a square. The expression  $8^4$  is more opaque and less transparent than the first example, but the squareness is still somewhat evident if only attending to the exponent in the expression.  $16^3$  is now very opaque as the exponent shows no sign of the expression being a square number and the square number must be found by attending to the base of the expression to discover the square. Note that all of these are different representations of the number 4096, which is now very opaque to the squareness.

The role of representation dealing with numbers, rather than algebraic or geometric or other mathematical representations, has been well documented with respect to prime numbers (Zazkis & Liljedahl, 2004; Zazkis, 2005), irrational numbers, (Zazkis & Sirotic, 2004; Zazkis, 2005), divisibility and prime factorization (Zazkis & Campbell, 1996; Zazkis, 2008), but not with square numbers or square roots.

The lack of transparent representation has been found to be hindrance to students when solving problems or attempting to generate examples. However, if students do not have a clear understanding of the structure of a problem or expression, a transparent representation will not guarantee success. Zazkis and Sirotic (2004) found that only 60% of respondents gave the correct response to the question of whether  $53/83$  was rational or irrational after performing the division on a calculator. Although the representation of the number was transparent to rationality a large proportion of respondents did not attend to this representational feature. These students were not attending to the rational expression, but were focused instead on the partial decimal representation shown by their calculators. While studying divisibility, Zazkis and Campbell (1996) found that students must have sufficient understanding of the multiplicative structure in order to attend to the transparent features of an analogous problem.

## **METHODOLOGY**

This study followed the methodology of modified analytic induction, as laid out by Bogdan and Biklen (1998). Modified analytic induction requires a phenomenon of interest and a working hypothesis or theory. One develops a loose descriptive theory, collects data and then recursively rewrites and modifies both the theory and even the phenomenon of interest to fit the new data. Modified analytic induction uses purposeful sampling in order to choose subjects that will facilitate the expansion of the developing theory.

In this study, the phenomenon of interest was students' understanding of square numbers and square roots, and in particular the obstacles that students encounter when attempting to solve problems with square numbers and square roots. The working theory that addresses these questions began as an assumption that the opaque representation of the expression would be an obstacle in students' ability to solve square number and square root problems.

### **The Participants**

The participants in this study were 51 grade 11 students. The students ranged greatly in ability; the group included some of the most mathematically talented students in the school as well as students who were much less capable. Pre-calculus students were chosen for this study in order to capture students with both a great deal of familiarity with square numbers and a wide range of knowledge and ability.

## The Instruments

Two instruments were used; a written questionnaire, completed by all participants and a follow-up semi-structured clinical interview designed to gain more insight into student responses from the questionnaire, completed by nine participants. The nine students who participated in the clinical interviews all had a grade of 'A' or 'B' in both their current mathematics course as well as their previous mathematics course. These students were selected through purposeful sampling by choosing students for the interview based on their willingness to explain their reasoning on the questionnaire responses and their willingness to attempt the problems in good faith.

## The Tasks

The questionnaire tasks were designed to investigate students' capacity to solve problems that moved from more transparent representations of square numbers through more opaque representations of square numbers. Two sample tasks are "Consider  $36^2$ ,  $36^3$ ,  $36^4$ ,  $36^5$ ,  $36^6$ ,  $36^7$ . Circle the perfect squares." and "How many perfect squares are there between 100 and 10,000?"

The clinical interviews were designed to gather additional information of a different nature than that gained from the questionnaire. While the questionnaire was designed to indicate *which* questions students had difficulty answering, the clinical interviews were designed to explore *why* students had difficulty answering a particular question.

## RESULTS

The questionnaire revealed that students have a great deal of difficulty with opaque representations of square numbers. The sample task "Consider  $36^2$ ,  $36^3$ ,  $36^4$ ,  $36^5$ ,  $36^6$ ,  $36^7$ . Circle the perfect squares." was only answered correctly by two of 51 participants, while 19 students only circled  $36^2$ , 17 circled  $36^2$ ,  $36^4$  and  $36^6$ , and 3 participants circled only  $36^2$  and  $36^4$ . Of the 51 participants, 39 or 76%, did not attend to the base of the expressions and were hampered by the opaque representation.

### Concept Definition Confusion

Over the course of the study students used many terms, some interchangeably, and did not seem to have a strong sense of their definitions. During the clinical interviews I used the terms square number, perfect square and square root; the students used these terms as well as additional terms such as non-perfect square, perfect number and others. The meanings given by each student to the terms in use were often inconsistent, unclear or incorrect. These meanings were often only implicit or assumed, from the context, as participants rarely offered any definitions. The concept definitions that students had were not universal and did not seem to be well defined.

A prime example of a clear confusion between concept definitions can be found in my interview with Jack. Jack was an exceptionally able student who answered the majority of questions on the questionnaire and during the interview correctly and swiftly, but he often needed to ask for clarification if I wanted a perfect square or the square root if I

used the term square number. At the end of the interview I asked explicitly for his definition of a square number, as I had noticed him using this term in an unusual manner previously in the interview.

Jack: Square number? Hmm. [pause] Umm, A whole number that is...that is being multiplied by itself to make a perfect square?

Jack was using the term square number to indicate the square root of a perfect square. He did not confuse perfect squares with square roots, but he was not sure about the term square number.

Another facet of the confusion with concept definitions came from Maya, who had been asked which of the following series are square numbers:  $36^2, 36^3, 36^4, 36^5, 36^6, 36^7, 36^8$ . She used her calculator and discovered that  $36^3$  is a square number and was very surprised.

Maya: Well because, what I understood of squares or perfect squares was that, well this would be a cube... wait that makes no sense cause it's a square still...but for a square what I thought they meant was like a 2D form...

Here Maya's definition of a square number was linked to her image of a square. In this case, her concept image of a square number was related to a geometric square, she was limited by this image in her mind and she had difficulty connecting it to the idea that a cube could also be a square number. Her concept image of a square number is narrower than it could be. Note also, the representation of  $36^3$  is transparent as to the number being a cube, but opaque to the number being a square. It is clear that Maya's definition of a square number did not rely on general factors or prime factors and may be quite different than that of her peers.

It is apparent from these examples that the definitions in use by the students are not always clear or consistent with mathematical conventions. Their definitions are also not locally consistent; these students do not share any definitions that are particular to their group. This may be due to the apparent lack of rigorous definitions supplied to students; students must therefore create their own concept definitions.

### **Inconsistent Concept Image**

During the clinical interviews analysis, I found a larger conceptual problem than one of just unclear definitions; that is inconsistent evoking of concept image.

Kennedy was asked to find a perfect square larger than 500. After finding a square number larger than the target number, she became confused when the square root was smaller than the target number.

Kennedy: Um,...[pause] I guess the perfect square of 1000, would be 100,000? Like the square root of 100,000, maybe? Am I allowed to use a calculator?

[...]

Ok, so I'm doing the square root of 10,000. Which is 100, so wait, that's not bigger than 500.

This is not an instance of simply forgetting the original question and this type of confusion was not a unique event as shown by Rachel. She was asked for a perfect square that has three digits. Rachel gave 10,000 as her final answer, because 100 squared is 10,000. Throughout her interview Rachel repeatedly but inconsistently exchanged the term square number for the square root.

Another particularly clear case of this confusion came once again from Maya. Maya became confused between the square number and its square root during a task that asked her to find the number of square numbers between 0 and 100.

Maya: Um, 2, no wait... the last one would be 10. Yeah, 2, 4, 9, ...4?

Interviewer: Ok so how did you come up with 4?

M: Umm, well the last perfect square is 100, so the square root of a hundred is 10.

Or, I don't know why I wrote that, but yeah its 10. Then you go back down to the next number, which is 9 that would be 81,...

But then 8 doesn't have a square root, nor does 7, nor does 6, nor does 5, but 4 and 2 do have one. No wait, 2 does not have one. Or does it have one? No 2 does not have one. I'll go 3. [laughs]

Or 1 wait. Is 1 a square root? I'm pretty sure 1 is a square root as well right?...I'm confused, hold on a second. Uh, yeah.

Maya was attempting to count the square numbers between 0 and 100; she gave her final answer on her paper as “4 – 1, 4, 9 and 100”. She began counting at 10, the square root of 100. Her confusion began just after counting 9, the square root of 81, because “8 doesn't have a square root” even though she had been working on the *square* of 9 not the *square root* of 9.

Like Kennedy and Rachel, there is an issue of losing sight of the problem due to the labels Maya internally assigned to numbers. Maya had 10 and then 9 in her head as square roots, but the fact that 9 is also a square number seems to have confused her. When she moved down her list to 8, she should have squared it but she became confused because she knew that 8 is not a perfect square as 9 is. Maya evoked her own concept image of 9 as a square number when she should have been evoking the image of 9 as a square root. It is not so much Maya had a confused image of either square numbers or square roots, but that she became confused during the problem about what she was trying to accomplish. Maya and others demonstrated a difficulty coordinating concept images consistently with their work.

## Representation

The opaque representation of square numbers was often an obstacle for students to overcome. The most common issue with representation was students who only attended to exponents in expressions when looking for square numbers. They did not attend to the base when determining if an expression was a square number, and in



compound expressions that contained an exponent, any number without an exponent was treated as not a square number.

During the clinical interviews, each student was asked the following two questions: “Can  $k^3$  ever be a square number?” and “Which of these numbers,  $36^2, 36^3, 36^4, 36^5, 36^6, 36^7, 36^8$ , are perfect squares?” However these questions were not always asked in this order. All participants who were asked about  $k^3$  first claimed that it could not be a square number. However, students that were asked about the series first, before the question about  $k^3$ , usually manually checked all the expressions and like Maya were surprised to find that  $36^3$  was a perfect square. Subsequently, they were able to correctly answer that  $k^3$  could be a perfect square for certain  $k$  when asked with that problem later in the interview.

When confronted with problems that forced students to attend to the base of a power expression, some students were more likely to attend to the bases in subsequent problems. However this was only common with problems that were very similar such as  $k^3$  and  $36^3$ . In unfamiliar problems most students continued to only attend to the exponents in the expressions, and were greatly hindered if the representation of a square number was not transparent in the exponent.

## CONCLUSION

This study has found that students do experience difficulty when working with square numbers and square roots, and although the topics may seem simple, there is a wide variety of ways in which to think about and work with square numbers. Students face significant obstacles with opaque representation and concept confusion related to indistinct concept definitions and inconsistent evoking of concept images.

In particular, the students in this study did not share agreed-upon definitions for the terms involved with the wider mathematical community. Some students were unsure if square numbers must be squares of integers, or if they could be any number that could be ‘square rooted’, while others believed that ‘square number’ meant ‘square root’ as opposed to perfect square. I suggest that the lack of clear and concise definitions of square numbers and square roots given to students, is also an obstacle for students to overcome when attempting to solve square number problems.

A unique finding of this study is the confusion demonstrated between the concepts of square number and square root. Many other students became confused while working through a problem, as to which type of number they were dealing with and which properties those numbers had. There exists for them a difficulty in consistent evoking of the appropriate concept image. To what extent this confusion is prevalent and to what extent this confusion stems from the nature of the similarity of the terms square number and square root remains to be determined.

This study adds to the body of knowledge on the role of the representation of numbers, in this case square numbers and square roots. Opaque representation was found to be a large obstacle for students when attempting to solve problems with square numbers or

square roots. When the representation was not transparent with respect to square numbers, students often claimed that the expression could not be a square number, without attempting to verify the statement. In this study students overwhelmingly did not attend to the base in exponential expressions.

## References

- Bogdan, R. C., & Biklen, S. K. (1998). *Qualitative research in education. An introduction to theory and methods*. Needham Heights, MA: Allyn & Bacon.
- Gough, J. (2007). Teaching square roots: Conceptual complexity in mathematics language. *Australian Senior Mathematics Journal*, 21(1), 53-57.
- Lesh, R., Behr, M., & Post, T. (1987). Rational number relations and proportions. In C. Janvier (Ed), *Problems of representation in the teaching and learning of mathematics* (pp. 41-58). New York, NY: Routledge.
- Tall, D., & Vinner, S. (1981). Concept image and concept definition in mathematics with particular reference to limits and continuity. *Educational Studies in Mathematics*, 12(2), 151-169.
- Zazkis, R. (2005). Representing numbers: Prime and irrational. *International Journal of Mathematical Education in Science and Technology*, 36(2-3), 207-217.
- Zazkis, R. (2008). Divisibility and transparency of number representations. In M. P. Carlson & C. Rasmussen (Eds.), *Making the connection: Research and practice in undergraduate mathematics: MAA notes #73* (pp. 81-92). Washington, DC: MAA.
- Zazkis, R., & Campbell, S. (1996). Divisibility and multiplicative structure of natural numbers: Preservice teachers' understanding. *Journal for Research in Mathematics Education*, 27(5), 540-563.
- Zazkis, R., & Gadowsky, K. (2001). Attending to transparent features of opaque representations of natural numbers. In A. Cuoco (Ed.), *NCTM 2001 yearbook: The roles of representation in school mathematics* (pp. 41-52). Reston, VA: NCTM.
- Zazkis, R., & Liljedahl, P. (2004). Understanding primes: The role of representation. *Journal for Research in Mathematics Education*, 35(3), 164-186.
- Zazkis, R., & Sirotic, N. (2004). Making sense of irrational numbers: Focusing on representation. In M. J. Høines & A. B. Fuglestad (Eds.), *Proc. 28<sup>th</sup> Conf. of the Int. Group for the Psychology of Mathematics Education* (Vol. 4, pp. 497-504). Bergen, Norway: PME.

# INTERACTIVE CONSTRUCTION OF ATTENTION PATHS TOWARD NEW MATHEMATICAL CONTENT: ANALYSIS OF A PRIMARY MATHEMATICS LESSON

Keiko Hino<sup>1</sup>, Yuka Koizumi<sup>2</sup>

<sup>1</sup>Utsunomiya University, <sup>2</sup>University of Tsukuba

*On the basis of the construct of “discursive focus” by Sfard (2000), this study explores how students’ attention is brought to new mathematical content in whole-class interaction between the teacher and the children. In a sixth-grade lesson introducing the concept of constancy of proportion, we analyzed the progression of social interaction in terms of how different foci were presented, problematized, or modified. The results show that the children’s vague attention to the constant number was questioned and made an object of examination. The children’s attention was then carefully controlled by involving them in building new perspectives, which became the basis for making sense of constancy of proportion. We also point out several significant teaching actions for making this process happen.*

## BACKGROUND AND PURPOSE OF THE STUDY

Over the past few decades, more studies have been conducted to unpack features of classroom discourse that provides rich learning opportunities. Some researchers study the form and structure of exchanges between teacher and students in terms of hidden classroom-interactive patterns (e.g., Voigt, 1985; Wood, 1998). Many studies also explore the mode and format of classroom communication in which students engage in argument (e.g., Lampert & Blunk, 1998; Krummheuer, 1995). Building on these studies, we have proposed a social interaction pattern to capture interactions in lessons introducing new mathematical content (Koizumi & Hino, in preparation). By examining a primary mathematics lesson conducted by an experienced teacher, this paper proposes to clarify the ways children’s attention is brought to new mathematical content in whole-class interactions after their individual activity.

One of two reasons for exploring this type of classroom interaction is that few studies have concentrated on the social interaction pattern that discloses the students’ elaboration process for their ideas about lesson objectives. Several proposed patterns show that the teacher’s purpose receives more weight than students’ thinking (e.g., Voigt, 1985). In the alternative pattern, students take conversational control, and they are responsible for re-explaining their thinking to others (e.g., Wood, 1998). The analysis of classroom episodes mainly concerns how students are helped by the teacher to talk about important mathematical ideas with respect to a solution given by one student; however, learning opportunities would be embedded in various interactional contexts during the lesson. To deepen our understanding of the relationship between social interaction and the development of students’ mathematical thinking (Wood et al., 2006), we believe that whole-class interaction directed to new mathematical

content will offer important information. The second reason is that this type of interaction requires the teacher to fulfill active roles in comparing, integrating, or evaluating varied solutions presented by the students. Walshaw and Anthony (2008), in their literature review on teachers' roles in developing high-quality classroom discourse, repeatedly assert the importance of a teacher who does *not* simply hear and accept all answers, but *attentively listens to the mathematics in students' talk*. In this paper, we intend to concretize the teacher's role by observing and analyzing what an experienced teacher actually does during such interactions.

Thus, this paper addresses two research questions: (i) What are the paths of children's attention to new mathematical content? (ii) What kinds of leadership does the teacher employ to catalyze this process?

## THEORETICAL FRAMEWORK

In our investigation, we use the construct of discursive focus by Sfard (2000). Pursuing the construction of mathematical objects from the discourse perspective, Sfard argues that the effectiveness of verbal communication is determined by degree of clarity of discursive focus presented within the communication. In doing so, she distinguishes three components of focus employed to grasp the object of attention. *Pronounced focus* is "the word used by an interlocutor to identify the object of her attention" (p. 304). *Attended focus* is "what and how we are attending—looking at, listening to, and so forth—when speaking" (p. 304). Finally, the *intended focus* is the "interlocutor's interpretation of the pronounced and attended foci"; this component includes "the whole cluster of experiences evoked by these other focal components as well as all the statements he or she would be able [to] make on the entity in question, even if they have not appeared in the present exchange" (p. 304). Although intended focus is less tactile than the other two, its presence can be signaled by particular discursive clues or the speaker's tendency to interchangeably use different names. According to Sfard, this focus indicates an actual, context-dependent discursive occurrence. When these foci relate to some stable, self-sustained entity, *an object is constructed discursively*. The discursive objects come into being (or into the signifier's realization) by the important processes of naming, encapsulating, and reifying (Sfard, 2008, pp. 170-171).

The three foci have helped make transparent the teacher's support and guidance in the interaction progress for an introductory lesson to new mathematical content (Koizumi & Hino, in preparation). In the present paper, we further analyze the interaction in another sixth-grade lesson conducted by the same teacher. Comparing this lesson with the previous one, we found that children in this lesson struggled more in the presented task by the teacher.

## RESEARCH METHOD

In January and February 2009, ten consecutive lessons were implemented and recorded in a sixth-grade classroom in a public primary school in Japan. The lesson topic was *proportional relationship*. When the data were collected, the teacher had 30 years of

teaching experience and occupied the school's position as head of mathematics curriculum and instruction.

These lessons were recorded according to the *Learners Perspective Study – Primary* data-collection procedure by revising the *Learners Perspective Study* methodology (Shimizu, 2011). In the classroom, three cameras (focused on the teacher, target children, and the whole class) video recorded each lesson. After each lesson, the target children were interviewed about what they studied in the lesson and what they thought was important. The teacher was interviewed twice about her thinking and emotions during the lesson. In addition, she was asked to write the goal of each lesson, along with her personal reflections.

In these lessons, children were introduced to the concept of proportional relationship mainly through tables. With tables, proportional relationship was defined on the basis of co-variation between two quantities, as shown in Lesson 2 (L2) of Table 1, below. The relationship between two quantities,  $\triangle$  and  $\circ$ , was also formulated in the equation " $\circ \times \text{fixed number} = \triangle$  and  $\triangle \div \circ = \text{fixed number}$ " (L5). Graphical representation of a proportional relationship was also introduced by plotting several points and observing their arrangement as a straight line traveling through the point where both quantities are zero (L6, L7).

Lesson	Topic	Lesson	Topic
1	Exploring the relationships of two quantities varying together.	6	Representing the relationships of two quantities with graphs.
2	Definition of proportional relationship	7	Exploring the features of the graph.
3	Checking whether two quantities are in the proportional relationship.	8	Appreciating the value of graph. Exercises.
4	Making tables and checking whether two quantities are proportional.	9	Exercises (Using digital material)
5	Finding constancy of proportion in the relationship of two quantities.	10	Challenging exercises.

Table 1: Topics of the Ten Lessons

In this paper, we use the data on L5 intended to introduce new mathematical content to the children. Analysis was qualitatively conducted to capture the teacher's methods of eliciting and organizing the children's thinking when introducing new mathematical content. In the first stage of analysis, we identified the phases and activities in the transcripts of "public" talk by the children and the teacher. Using Sfard's three foci in the second stage, we discerned specific instances of the teacher's support and guidance during the interaction process. Our interest especially concerns how the focus is modified or a new focus is built and what role the teacher plays. We corroborated some of our interpretations with the data from the teacher and the targeted children.

## CLASSROOM EPISODE AND INTERPRETATION

Lesson 5 aimed to find constancy of proportion in the relationship of two quantities and to express it in the form of an equation. Since L2, the class had been studying the *horizontal* (co-variation) relationship in a situation of pouring water into a tank using a table showing various amounts of time and the corresponding depths of water in the tank. In L5, the teacher used the same task, but this time she intended the children to *vertically* (correspondence) look at the table to derive constancy of proportion.

Phase	Activity																						
Proposing the problem	<p>The teacher presented the task. She distributed the worksheets below to children.</p> <div style="border: 1px solid black; padding: 10px;"> <p>Let's examine in more detail the relationship in which depth of water is proportional to time. Let's find the fixed number that does not change by vertically looking at the table.</p> <table border="1" style="width: 100%; text-align: center;"> <thead> <tr> <th>Time (min)</th> <th>1</th> <th>2</th> <th>3</th> <th>4</th> <th>5</th> <th>6</th> <th>7</th> <th>8</th> <th>9</th> <th>10</th> </tr> </thead> <tbody> <tr> <th>Depth (cm)</th> <td>2</td> <td>4</td> <td>6</td> <td>8</td> <td>10</td> <td>12</td> <td>14</td> <td>16</td> <td>18</td> <td>20</td> </tr> </tbody> </table> </div>	Time (min)	1	2	3	4	5	6	7	8	9	10	Depth (cm)	2	4	6	8	10	12	14	16	18	20
Time (min)	1	2	3	4	5	6	7	8	9	10													
Depth (cm)	2	4	6	8	10	12	14	16	18	20													
Individual activity																							
Eliciting children's ideas	<p>Children presented their ideas.</p> <p>AO: I think that 2 x of <i>time</i> is the <i>depth of water</i>.</p> <p>IT: I found that if I divide the <i>depth of water</i> by 2, it becomes the <i>time</i>. This can be said to all the values, well..., if I used <math>4 \div 2</math>, then it becomes 2, which is the <i>time</i>. Therefore, I think this [2] can be said to be the number not moving. Therefore, I think that the <i>depth of water equals the time divided by 2</i>.</p> <p>The teacher pointed out that if we apply IT's idea to the equation, it becomes <math>2 = 1 \div 2</math>. TA proposed the equation <math>\text{depth of water} \div 2 = \text{time}</math>. Then, several children talked about 0.5 as a constant number. Finally, NA spoke that <i>depth of water divided by time becomes 2 all the time</i>.</p>																						
Focusing on the object of examination	<p>The teacher proposed that the fixed number should be 2 based on the logic that the <i>depth of water</i> increases 2 cm every time 1 min.</p>																						
Formulating the result on the basis of the object	<p>The teacher said that the proportional relationship can be expressed by <math>\circ \times 2 = \Delta</math> and <math>\Delta \div \circ = 2</math> using <math>\circ</math> as <i>time</i> and <math>\Delta</math> as <i>depth of water</i>. She also mentioned that the <i>fixed number</i> is 2 this time and that the number can vary according to the proportional relationship in the situation.</p>																						

Table 2: Phases and Activities in Lesson 5

When presenting the task, the teacher clearly stated the lesson's goal: "Today, I want you to find the vertical relationship." When she explained the worksheet distributed to the children (see Table 2), she said more about the vertical relationship: "I stressed the point of finding the fixed number that does not change at all when you look at the vertical relationship in the table." Then, as usual, the teacher spent some time allowing the children to work on the task in their own ways. The task was not easy for many of the children. In particular, they were observed to have difficulty in formulating the equation ( $\text{depth} \div \text{time} = 2$ ), which was the objective of L5. In the following section, we describe the whole-class interaction after the individual activity, especially focusing on the phase "eliciting children's ideas."

## Correcting a Mistake by a Child

Two children, AO and IT, presented their findings on the blackboard (Figure 1).

(Time)		(Time)	
(Depth)		(Depth)	
	(Time × 2 = Depth of Water) 時間 × 2 = 水の深さ 1 × 2 = 2    2 × 2 = 4    etc.		(Depth of Water = Time ÷ 2) 水の深さ = 時間 ÷ 2

Figure 1: Work presented by two children: AO (left) and IT (right)

Although IT's equation was not correct, other children raised their hands to show their agreement with IT's work. Then the teacher questioned the correctness of his equation:

- 01 T: By the way, IT, if we put 1 in the *time* [in your equation], then it becomes  $1 \div 2$ . This makes the *depth of water* strange, don't you think?

After the teacher's comment, TA proposed the equation  $\text{depth of water} \div 2 = \text{time}$  by explaining her reasoning:

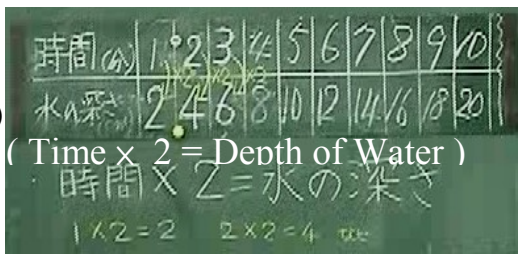
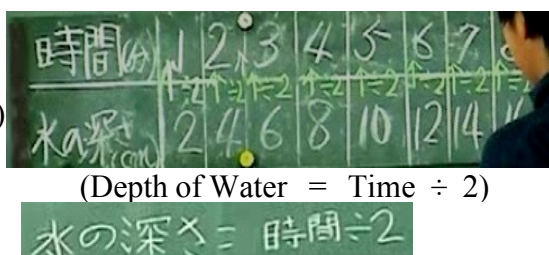
- 02 TA: For example, if the *depth of water* is 2 and time is 1, then  $2 \div 1$  is 2, and if the depth is 4 and time is 2,  $4 \div 2$  becomes 2.

By interrupting IT when he was trying to erase his equation, the teacher continued the conversation.

- 03 T: Let's look at what the differences are [in these two equations].
- 04 T: Very good, they gave us very good examples [to consider]. We'd better substitute them [the word in the equation] with different numbers, I mean numbers. If we change the *time* to 1 in the equation made by IT, if we make *time* into 1, then it eventually becomes  $1 \div 2$ . Don't erase it. Please write it above [the equation]. It's  $1 \div 2$ . Please write 1 above the time and write  $\div 2$ .
- 05 T: [IT wrote above his equation, as directed.] Yes, that's right. Let's write " $1 \div 2$ " there.
- 06 S: It's 0.5.
- 07 T: And then, what is the answer?
- 08 S: 0.5.
- 09 T: It becomes 0.5,... it looks odd. It doesn't become the *depth of water*, does it?
- 10 S: Oh... no, it doesn't.
- 11 T: Are you OK? OK? Let's see about TA's [equation]. How about TA? If we put 4, 4, in the "*depth of water*" [in her equation], 4 divided by 2 is... does it become *time*?
- 12 S: Yes, it becomes *time*.
- 13 T: Does everyone understand? Are you all right with this?

**Interpretation:** When IT presented his work (see Table 2), he provided a focus with respect to the constancy of proportion in the table. He expressed it as *the number not moving* (pronounced focus). It accompanied attended focus with arrows and  $\div 2$  in all

of the corresponding cells in the table (see Figure 1). He further explained his reasoning with his hand moving, which served as the attending procedure. However, his pronounced and attended foci were concerned only with the table. It is likely that his intention to identify the common number resulted in relating two numbers in the upper and lower rows. Weak focus on the equation was also observed in other children, as evidenced by some who agreed with IT. Noticeably, TA showed similar focal behavior even though she developed the correct equation (line 02).

Then, the teacher focused the children's attention on the differences between the two equations by comparing them in relation to the corresponding table (lines 03-12). During the interaction, the teacher closely looked into the two equations by connecting each word and symbol in the equation with the numbers in the table. She provided an attending procedure, i.e., *dividing the number in the upper row by 2 in the equation and checking whether the answer is the number in the corresponding lower row* (line 04). This was the first time that the class explicitly attended to the table in relation to the equation. This procedure involved the children in the process, rather than employing teacher's explanation. As a result, several children vocalized their understanding in line 10. In line 11, they applied the same attending procedure to TA's equation.

### Children's Proposing New Equation

Then, several children began to talk about  $0.5$  as a constant number:

- 14 S: Teacher. Well... These people thought...
- 15 S: All of them are  $0.5$ .
- 16 S: It is  $0.5$ .
- 17 S: If we divide *time* by 2, all of them can become  $0.5$ ...
- 18 T: Oh, well. If we divide *time* by 2...
- 19 S: They all become  $0.5$ .
- 20 S: Yes, you are right.
- 21 T: Oh..., *time* divided by 2. Yes.
- 22 S: Let's see. ... All are  $0.5$ , aren't they!
- 23 T: Oh, well, but, *time* divided by 2, what? If we divide *time* by 2, then, let's see... what? What do you mean by *time*? Do you mean to divide [all of] 1, 2, 3, 4, 5, 6, 7, 8, 9, and 10 by 2? What do you mean?

Here SU raised his hand and conveyed his thinking about the object of discussion:

- 24 SU: Yes. Well, I mean what these people were saying before. I would say to divide *time* by *depth of water*; then, it becomes  $0.5$ . I think it will become  $0.5$  if we do  $1 \div 2$ ,  $10 \div 20$ ,  $7 \div 14$ , or  $5 \div 10$ .

Interpretation: The children actively stated, *all of them are 0.5* (lines 15, 16). *All of them* (pronounced focus) again lacked clarity, and this triggered a child to vocalize an attending procedure (line 17). Because the child attended only to the table, the teacher intervened by questioning the validity of *time divided by 2 is 0.5* (line 23). She specifically mentioned the location of values that should be caught by careful attention.



At this moment, she provided another important attending procedure to construct focus on constancy of proportion, i.e., *to check the equation by not only one pair of the first two numbers (1 and 2), but also multiple pairs of numbers in the table*. Then, SU clearly provided this attending procedure when she justified her equation (line 24).

### A Child's Proposing Another Equation

Another child, NA, raised her hand and proposed her equation:

- 25 NA: In my case, I did the *depth of water* divided by *time* and the *constant number*... (She went to the blackboard and wrote  $\text{depth of water} \div \text{time} = 2$ .) Well, I used this [equation] for every [number in the table]. I did the calculation *depth of water*  $\div$  for the numbers in other places, and they all become 2.

Interpretation: NA explained her equation by clearly mentioning that the equation is valid for every corresponding number in the table. She explicitly offered different pronounced foci “constant number,” “every,” “other places,” and “all.” They consistently suggest her intended focus on constancy of proportion, in which not only the table, but also the equation is assigned an important position.

### DISCUSSION

In the previous section, using the three foci, we illustrated how the children's attention shifted to new mathematical content. The children's vague attention to the constant number was repeatedly questioned and made an explicit object of examination. In this process, the children's attention was carefully controlled by involving them in building new attending procedures, which became the basis for making sense of constancy of proportion. Sfard (2000) argues that the lack of equilibrium between the focal ingredients (pronounced, attended, and intended foci) impels discursive growth. In our analysis, we also observed similar disequilibrium triggering the necessity of well-defined attended focus that guides the communicator's interpretations. Through these processes, the children's focus became clearer and more consistent, a process closely connected to developing comprehension of new mathematical content.

Importantly, the objective of L5 included a mathematical equation as the symbolic means for expressing constancy of proportion. For the children, expressing regularity in the form of an equation was a novel experience. It caused a certain perplexity, but at the same time, it enabled the participants to talk about the validity of different proposals on the constancy of proportion. The children and the teacher proposed, questioned, supplemented, or justified their ideas to shape a clear, precise focus on constancy proportion for the equation. Relying on the children's previous experiences in the lessons, different symbolic means contributed both as metaphor (table) and as rigor (equation), two important discursive steering forces (Sfard, 2000).

Furthermore, the results demonstrate that teacher played a significant role in successfully conducting this process. In attentive listening to the children's talk, the teacher carefully assessed the mathematics behind their talk. Moreover, she purposefully sustained the interaction by providing the foci necessary for them to make sense of new mathematical content. Here two observations should be noted. First, the

teacher knew when to intervene, i.e., intentionally to “step in and out” (Lampert & Blunk, 1998) of the interactions. The teacher intervened in certain pronounced foci, especially weak focus on the constancy of proportion in the equation, and made it a target of examination. Second, her supportive method of providing the foci was responsive rather than directive (Walshaw & Anthony, 2008). The teacher provided two important attended foci and procedures of relating the equation to numbers in the upper and lower rows of the table. Both were provided in the middle of interactions with the children, rather than in sole, advance explanation by the teacher.

It should be noted that these actions are closely linked to the teacher’s conscious lesson objectives (Koizumi & Hino, in preparation). Therefore, children’s paths to new mathematical content become clearer when they are examined throughout the phases of a lesson, and furthermore, in the sequence of lessons. At the same time, since our results are based only on a case study, we need additional analyses of classroom interactions to identify more and other teacher actions in providing children with focus building and refining activities when presenting new mathematical content.

## References

- Funahashi, Y., & Hino, K. (in press). The teacher’s role in guiding children’s mathematical ideas toward meeting lesson objectives. *ZDM*.
- Krummheuer, G. (1995). The ethnography of argumentation. In P. Cobb & H. Bauersfeld (Eds.), *The emergence of mathematical meaning: Interaction in classroom cultures* (pp. 229-269). Hillsdale, NJ: Lawrence Erlbaum Associates.
- Lampert, M., & Blunk, M. L. (Eds.). (1998). *Talking mathematics in school: Studies of teaching and learning*. Cambridge, UK: Cambridge University Press.
- Sfard, A. (2000). Steering (dis)course between metaphors and rigor: Using focal analysis to investigate an emergence of mathematical objects. *Journal for Research in Mathematics Education*, 31(3), 296-327.
- Sfard, A. (2008). *Thinking as communicating*. Cambridge, NY: Cambridge University Press.
- Shimizu, Y. (Ed.). (2011). *Cross-cultural studies of mathematics classrooms from the learners’ perspective: Research report of grants-in-aid for scientific research by Japan Society for the Promotion of Science* (No. 19330196) [in Japanese]. Tsukuba, Japan: University of Tsukuba.
- Voigt, J. (1985). Patterns and routines in classroom interaction. *Recherches en Didactique des Mathématiques*, 6(1), 69-118.
- Walshaw, M., & Anthony, G. (2008). The teacher’s role in classroom discourse: A review of recent research into mathematics classrooms. *Review of Educational Research*, 78(3), 516-551.
- Wood, T. (1998). Alternative patterns of communication in mathematics classes: Funneling or focusing? In H. Steinbring, M. G. Bartolini Bussi, & A. Sierpiska (Eds.), *Language and communication in the mathematics classroom* (pp. 167-178). Reston, VA: NCTM.
- Wood, T., Williams, G., & McNeal, B. (2006). Children’s mathematical thinking in different classroom cultures. *Journal for Research in Mathematics Education*, 37(3), 222-255.

# VISUAL AND ANALYTICAL STRATEGIES IN SPATIAL VISUALIZATION: PERSPECTIVES FROM BILATERAL SYMMETRY AND REFLECTION

Siew Yin Ho, Ajay Ramful, Tom Lowrie

Charles Sturt University & University of Canberra, Australia

*This case study contrasts the strategies used by two students in solving bilateral symmetry and reflection tasks, based on the differential properties they attended to. The ninth grader focussed on congruence of sides as the main property of reflection whereas the eighth grader focussed on perpendicularity and equi-distance, as is the normative procedure. The inadequate criteria for reflection shaped the ninth grader's actions and equally served to validate her solutions, although in a flawed fashion. The visual strategy took over as a fallback measure. We attend to some of the well-known constraints that students encounter in dealing with symmetry, particular situations involving slanted line of symmetry. Importantly, we made an attempt to show how visual and analytical strategies interact in the production of a reflected image.*

## INTRODUCTION

Understanding the ways in which visual and analytical strategies interact in the solution of mathematical problems has been one of the challenging questions for mathematics educators. Some steps have been taken to explain such an interaction. For instance, Hoyles and Healy (1997) showed how students attempted to synthesize the visual anticipation of the solution and their analytic symbolic representations in a microworld environment which equally allowed dynamic actions. In their analysis of the role of visual reasoning, Hershkowitz, Arcavi, & Bruckheimer (2001) suggested that visualization can be an analytical process itself. In fact, symmetry has conceptual foundations that can be investigated through visual and analytic strategies.

Research conducted since the 1980s has consistently shown that the apparently simple concept of symmetry is problematic for many students. One of the first extensive studies conducted in this domain is by Küchemann (1981) who identified five essential variables that influence students' ability to perform bilateral symmetry, namely the slope of the line of symmetry, the slope of the object, the complexity of the object, the existence or absence of intersection between the object and the line of symmetry, and the presence or absence of a grid in the problem. The variables identified by Küchemann were analysed in further depth by Grenier (1985) in her dissertation study to investigate patterns of errors. Recent studies (e.g., Bulf, 2010; Ho & Logan, 2013) continue to highlight the influence of such variables in students' performance.

Although much is known about the type of variables that affect students' ability to perform bilateral symmetry and reflection, the source of the respective difficulties has not been thoroughly investigated. In this paper, we use constructs from the area of

spatial visualization to analyse the processes behind students' strategies and errors (intuitive or learned) in performing bilateral symmetry and reflection tasks. We address the following research questions: (1) What are the sources of conceptual difficulties associated with slanted lines of symmetry? (2) How are visual strategies enacted in bilateral symmetry and reflection tasks? (3) How do visual and analytical strategies interact in the production of the image from the object?

## CONCEPTUAL FRAMEWORK

We analysed the data using constructs from the domain of spatial visualisation which essentially refers to the ability to generate and manipulate images (Yakimanskaya, 1991). Yakimanskaya considers images as the basic operative units of spatial visualization. Additionally, according to Kosslyn (1990), imagery is used "when we reason about the appearance of an object when it is transformed, especially when we want to know about subtle spatial relations" (p. 75).

We now explain how we interpret spatial visualization in relation to the types of symmetry and reflection tasks that students are generally called upon to perform in school mathematics, as is the case in the present study. We distinguish between two types of mental actions where spatial images are involved in reflection tasks in terms of the following visual anticipatory action or imaginative construction:

(i) visual-mental reflection: The visual/mental action of anticipating the image of an object from a line of symmetry. This process occurs when a printed object on paper (either plain or grid paper) is to be reflected given a line(s) of symmetry.

(ii) visual-mental folding: The visual/mental action of imagining the shape of an object being folded to determine the one-to-one geometric or morphological correspondence between the parts of an object. This process occurs in finding the lines of symmetry of shapes or alphanumeric characters.

The two operations described above were defined on the basis of the observations that we made as the participants interacted with the tasks. We refer to a *visual strategy* when attention is given to the use of imagery as related to shape, location/position, orientation and global perception. Such a strategy may equally include kinaesthetic imagery, as will be shown in the data analysis. Reflection, as a transformation, constitutes an isometry as it preserves length, shape and angle. The two main properties that are useful to reflect an image on a line of symmetry are (i) perpendicularity between corresponding points on object and image and (ii) equidistance between object, line of symmetry and image. We use the term *analytical strategy* whenever explicit reference is made to the properties (in terms of following a rule) in performing a reflection, finding the line(s) of symmetry or in the construction of a symmetrical object.

We used the concept of local and global perception from the psychology literature (Enns & Kingstone, 1995) in understanding the strategies used or constraints encountered by participants. In fact, Kosslyn (1990) suggests that imagery and

perception share common features. Psychologists use the term local perception to refer to the interpretation of an image when it is visually parsed into units. On the other hand, global perception refers to the overall structure of the image being processed. In analysing the videorecords, we could equally note how the participants were reorienting the diagrams by moving the worksheets or their posture, or used their fingers on the given diagrams in their imaginative actions. These observations indicated the importance of Presmeg's (1986) construct of kinaesthetic imagery.

## **METHOD**

The two participants of the study are identified by the pseudonym Brittany (Grade 9, age 15 years) and Sara (Grade 8, age 14 years). Each participant was individually interviewed by twice. Accessing mental images and visualization processes are methodologically challenging. In our attempt to capture the moment-by-moment responses of the participants, two cameras were used to record the four interviews so as to focus on their inscriptions and the movements that they made to track their kinaesthetic actions. The students were allowed to complete each task before they were asked to describe their strategies so as not to distort their thinking processes as suggested by Gutiérrez (1996).

The students were presented with four sets of tasks. In the first set, they were required to find the line of symmetry of a polygon (square, rectangle, equilateral triangle, cross, parallelogram and rhombus) and alphanumeric characters (S, X and Z). In the second set, they were asked to find the image of a given line segment or polygon reflected on a line of symmetry on grid paper (see Figures 1(a), 1(d) and 2 for sample tasks). In the third set, they had to complete the object from the partial object and the given number of lines of symmetry (see Figure 3(a) for sample task). In the fourth set, they had to reflect objects on slanted lines of symmetry, without the support of a grid (see Figures 3(c) and (d) for sample tasks). Due to space constraints, we present only selected tasks and responses.

## **RESULTS AND DISCUSSION**

### **The participants' prior knowledge of symmetry**

Brittany described reflection in terms of "exactly opposite" and "folding". The analytical property of 'equal distance' was well-established for her. However, at no point she made any reference to perpendicularity. Her conception of reflection was based on the more intuitive congruence property (referred to as congruence criterion), specifically the congruence between corresponding lengths in the object and image. She gave explicit description of her visual strategy to find the number of lines of symmetry in the alphanumeric characters (S, X and Z). For example, with regard to the letter 'S', she explained that she visualized a solid object: "Like, the shape. It's the shape of the S. So the paper was like cut out in the shape of the S and you can fold it."

On the other hand, Sara had a well-articulated analytical conception of reflection in terms of equal distance between object and image and line of symmetry (referred to as

equi-distance criterion). Particularly, her concept of perpendicularity (referred to as perpendicularity criterion) empowered her to unsparingly reflect objects in slanted line of symmetry. She would always focus on the ends of line segments or vertices of polygons in the application of the equi-distance and perpendicularity criteria. She clearly stated that points on a line of symmetry have no reflection. She described reflection in terms of a “mirror”.

### **(1) WHAT ARE THE SOURCES OF CONCEPTUAL DIFFICULTIES ASSOCIATED WITH SLANTED LINES OF SYMMETRY?**

The nature of the symmetry and reflection tasks dictates when perpendicularity is vital for successful problem solving. For vertical and horizontal lines of symmetry, perpendicularity is readily ensured. However, for slanted lines of symmetry such is not the case, although the visual appearance of the task in a grid may help. While the situations involving the horizontal and vertical lines of symmetry did not pose any constraint for Brittany, the slanted lines of symmetry revealed the inadequacy of her conception of symmetry. She focused on congruence of length as the main criterion of reflection and was not formally aware of the perpendicularity criterion. The second interview also confirmed that Brittany was not aware of the fact that the reflection of a point on a slanted line of symmetry is invariant under such a transformation.

We give a sample response to show the outcome of her focus on congruence of lengths for Task 1.8 (Figure 1(a)). As the given object (vertical line segment) crossed the line of symmetry, she interpreted the object as consisting of two parts. The motion of her pencil suggested that she was thinking about moving either to the right or left, at right angle to the object. She first decided to draw the image to the left of the object (see Figure 1(b)). She joined the two end points (labelled X and Y for explanation purposes) to find a means of getting equal distance between X and Y. Since the length on either side of the line segment XY was different, this led her to realize that this step is incorrect: “That's not really...”. At a later point, she changed her solution by drawing the image on the right of the object (see Figure 1(c)) and mentioned: “Because well this is one square like pass it. So if we do this it's got one part on this side too, the same amount on the other side.” Because the length of the object and image above and below the line of symmetry was the same, she felt confident that she performed the reflection correctly. Further evidence of her reliance on congruence could be observed by comparing the object and its corresponding image in Figures 1(d) and 1(e) respectively.

In contrast, Sara's consistent approach involving equi-distance and perpendicularity properties showed that she had a well-established scheme for lines of symmetry. For example, in Task 1.3 (see Figure 2(a)), she mentioned: “I used the boxes. I made a perpendicular line with my ruler. And then I saw how many boxes I needed.”

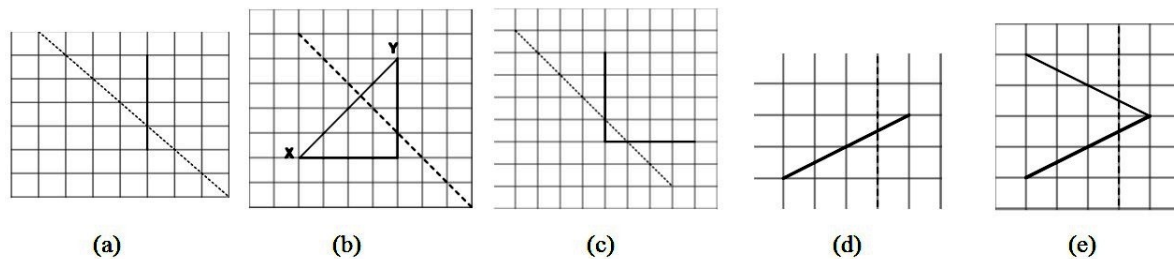

Figure 1: Brittany's responses to Set 2

Our findings led us to conjecture that students' responses to slanted line of symmetry tasks are also dependent on whether the objects are closed or open. A line segment (e.g. Fig. 2(a) and (c)) was more challenging to reflect as compared to when it was part of a figure (e.g. Fig. 2(d) where polygon L contains vertical and horizontal line segments). Furthermore, it appears that the orientation of the object relative to the slanted line of symmetry tends to suppress the global perception necessary to visually check the soundness of the image produced, an observation equally made by Küchemann (1981) and Grenier, (1985). In Task 1.7 (see Figure 2(c)), Brittany merely extended the object vertically down by 4 units, while in Task 1.6 (see Figure 2(b)), she produced the correct image.

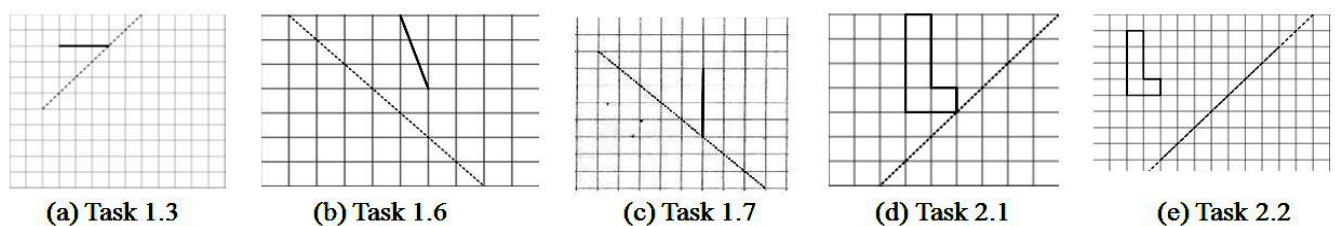

Figure 2: Sample tasks from Sets 1 and 2

In summary, absence of formal awareness of the perpendicularity criterion and failure to recognize that points on line of symmetry are invariant under a reflection, accounted for the difficulties that Brittany experienced with slanted lines of symmetry.

## (2) HOW ARE VISUAL STRATEGIES ENACTED IN BILATERAL SYMMETRY AND REFLECTION TASKS?

We observed four distinct ways in which visual strategies directed the participants' actions in performing the symmetry and reflection tasks.

### Imagining lines of symmetry

We could access Brittany's visual strategy in Set 3 (see Figure 3(a) for sample task) by her actions of positioning an imaginary line of symmetry (as could be inferred by the motion of her pencil) generally in the sequence, vertical, horizontal and slanting to then mentally reflect the shaded cells given in the tasks. She focused not only on the shaded parts but equally looked at the continuous shape made by the unshaded parts. For example, in Task 3.1 (shade one more square so that the diagram has two lines of

symmetry), she focused on the letter H formed on shading the required cell (see Figure 3(b)) to confirm that there were two lines of symmetry.

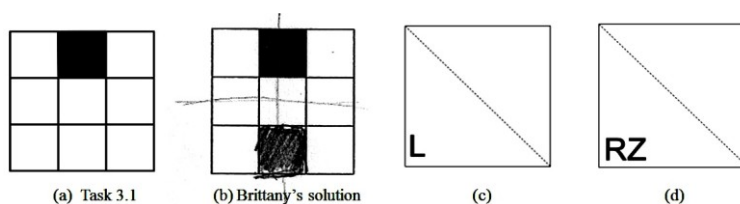

Figure 3: Sample tasks from Sets 3 and 4

### Reorientation of slanted line of symmetry to the vertical

To work with situations involving slanted line of symmetry, particularly when a grid was not available, Brittany and Sara would turn the line of symmetry in a vertical orientation. This reorientation was particularly apparent in Set 4 (Figures 3 (c) and (d)). The visual/perceptual facility afforded by the vertical reorientation of the line of symmetry was explicitly highlighted by Brittany: “If you tilt it (to the vertical) this way, I could just have to work out where it will be”. Psychologists in the area of perception (Giannouli, 2013) made similar observations, claiming that the vertical orientation is favoured by human beings.

### Reflection of part of object as a visual trigger

In some cases, the reflection of one part of the given object served to open the space for reflection of the whole object in the slanted line of symmetry. We could observe such a visual trigger in Figure 2(d). Brittany first reflected the horizontal segment (touching the slanted line of symmetry) in the letter L. Then she reflected the vertical segment (touching the slanted line of symmetry). These two initial constructions apparently served as a trigger for her to spontaneously identify the next part of the image and she quickly proceeded to construct the image, measuring the length of the different parts of the object by counting the number of cells. Küchemann(1981) described this strategy as semi-analytic. However, in Figure 2(e) involving the same object at a distance from the line of symmetry, she could not find the image of one part of the object to serve as a visual trigger for the whole image.

### The visual strategy as a visual check

In a number of cases, we could observe how the students inspected their solution as a whole (global perception) to verify whether the image was correctly drawn. For instance, in Task 2.6 (See Figure 4(a)), where the line of symmetry was not inclined at 45°, both of them could observe that their initial solution was incorrect. Another example is in Set 4 (Figure 3(c) and 3(d)) where Brittany compared the orientation of the alphanumeric characters and their image after reflection in the slanted line of symmetry. She justified her image by mentioning: “It looks correct”. Although Sara used such a visual check, she tended to rely more on her local perception emanating from her primarily analytical approach. In other words, she implemented her



equi-distance and perpendicularity criteria systematically right away and did not seem to find the necessity to rely on the visual approach, except as a check.

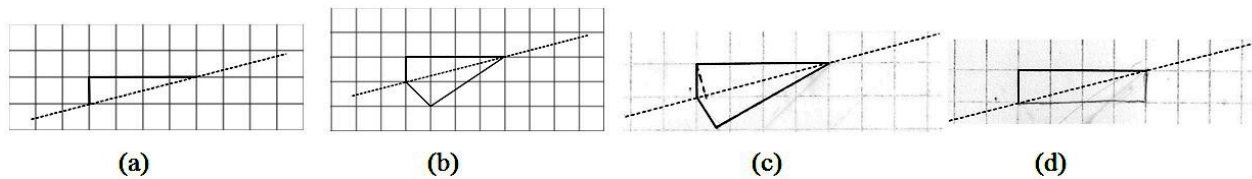

Figure 4: Task 2.6

### (3) HOW DO VISUAL AND ANALYTICAL STRATEGIES INTERACT IN THE PRODUCTION OF THE IMAGE FROM THE OBJECT?

We present excerpts to show how the visual and analytical strategies were conjointly used to produce the image. In Task 2.6 (Figure 4(a)), Sara first drew Figure 4(b) and visually analysed the drawing to mention: “no, it can’t be good”. Then, she used her ruler to set the perpendicular distance (dotted line in Figure 4(c)) to help her draw the image. Brittany initial construction was similar to Figure 4(b) and she could observe that it was incorrect and mentioned: “trying to visualize the whole thing but...” She pursued further with her “congruence of length” criterion to draw the image (see Figure 4(d)). In other words, the incorrect appearance of the image prompted her to switch to the analytical strategy.

#### The visual strategy as a scaffold for the analytic strategy

In some of the tasks, the students asserted that they made a global picture of how the image would look like before actually applying the analytical properties of symmetry and reflection. In Set 4 (see Figure 3(c)), Sara first mentally folded the object before applying the equidistance and perpendicularity criterion. In cases where she experienced constraint, Brittany depended on the visual to scaffold her analytical strategy, “congruence of sides” as in Task 1.8 (see Figure 1(a)). Here, the visual strategy took over as a more intuitive fallback measure. The students also used kinaesthetic imagery in starting their solution. For instance, Brittany tended to pull the page up on the corner in imitating a folding action in Set 4 (See Figures 3(c) and 3(d)).

### CONCLUSION

By focusing on spatial visualization, this study enhances our understanding of the subtle interaction between visual and analytical strategies in relation to symmetry and reflection tasks. It explains the constraints associated with the slanted line of symmetry identified by the seminal work conducted by Küchemann (1981) and Grenier (1985). Parallel to the work of Hoyles and Healy (1997), it explains how the meaning of symmetry is negotiated via visual and analytical strategies. More importantly, it attempts to make explicit the layers of complexity inherent in what is usually regarded as seemingly simple concepts, i.e., symmetry and reflection. It is acknowledged that this two-participant contrasting case study is bound to be limited in scope. However, the ways in which it portrays the explicit students’ actions with the symmetry and

reflection tasks is informative for teachers. The constraints that Brittany encountered with slanted lines of symmetry are not uncommon among students and serve to highlight the necessity to give more attention to the perpendicularity criterion. Ignorance of this criterion may be carried over to adulthood. The data also prompts us to suggest the consideration of global perception as a visual check in instruction on reflection. This study equally brings forth the importance of local and global perception as influential elements in students' reasoning, an aspect that requires further exploration.

## References

- Bulf, C. (2010). The effects of the concept of symmetry on learning geometry at French secondary school. In V. Durand-Guerrier, S. Soury-Lavergne, & F. Arzarello (Eds.), *Proc. 6<sup>th</sup> Conf. of European Research in Mathematics Education* (pp. 726-735). Lyon, France: CERME.
- Enns, J. T., & Kingstone, A. (1995). Access to global and local properties in visual search for compound stimuli. *Psychological Science*, 6(5), 283-291.
- Giannouli, V. (2013). Visual symmetry perception. *Encephalos*, 50, 31-42.
- Grenier, D. (1985). Middle school pupils' conceptions about reflections according to a task of construction. In L. Streefland (Ed.), *Proc. 9<sup>th</sup> Conf. of the Int. Group for the Psychology of Mathematics Education* (Vol. 1, pp. 183-188). Noordwijkerhout, NL: PME.
- Gutiérrez, A. (1996). Visualization in 3-dimensional geometry: In search of a framework. In L. Puig & A. Gutiérrez (Eds.), *Proc. 20<sup>th</sup> Conf. of the Int. Group for the Psychology of Mathematics Education* (Vol. 1, pp. 3-19). Valencia, Spain: PME.
- Hershkowitz, R., Arcavi, A., & Bruckheimer, M. (2001). Reflections on the status and nature of visual reasoning – The case of matches. *International Journal of Mathematical Education in Science and Technology*, 32(2), 255-265.
- Ho, S. Y., & Logan, T. (2013). Students' performance on a symmetry task. In V. Steinle, L. Ball, & C. Bardini (Eds.), *Mathematics education: Yesterday, today and tomorrow: Proc. 36<sup>th</sup> Conf. of the Mathematics Education Research Group of Australasia* (pp. 747-750). Melbourne, VIC: MERGA.
- Hoyles, C., & Healy, L. (1997). Unfolding meanings for reflective symmetry. *International Journal of Computers in Mathematical Learning*, 2, 27-59.
- Kosslyn, S. M. (1990). Mental imagery. In D. N. Osherson, S. M. Kosslyn, & J. M. Hollerbach (Eds.), *An invitation to cognitive science* (pp. 73-97). Cambridge: The MIT Press.
- Küchemann, D. K. (1981/1993). Reflections and rotations. In K. Hart (Ed.), *Children's understanding of mathematics 11-16* (pp. 137-157). London: John Murray.
- Presmeg, N. C. (1986). Visualization in high school mathematics. *For the Learning of Mathematics*, 6(3), 42-46.
- Yakimanskaya, I. S. (1991). *The development of spatial thinking in school children: Soviet studies in mathematics education* (Vol. 3). Reston, VA: NCTM.

# RELATING STUDENT OUTCOMES TO TEACHER DEVELOPMENT OF STUDENT-ADAPTIVE PEDAGOGY

Nicola Hodkowski<sup>1</sup>, Ron Tzur<sup>1</sup>, Heather Lynn Johnson<sup>1</sup>, Evan McClintock<sup>2</sup>

<sup>1</sup>CU Denver, <sup>2</sup>NYU

*We examine a 4<sup>th</sup> grade teacher's development of a constructivist-based, adaptive pedagogy (AP) approach—and its contribution to student multiplicative reasoning and outcomes, mixing qualitative analysis of segments from her interviews with quantitative analysis of her student outcomes on the state-mandated test. Her reflections indicate a shift to this pedagogical approach, which tailors the intended mathematics and classroom activities to students' available conceptions. The data reflect how, via professional development, her new understanding of students' learning to reason multiplicatively promoted learning opportunities for them and thus—their outcomes. We discuss how linking teacher development to student conceptions—adaptive pedagogy—can contribute to improving their outcomes.*

## INTRODUCTION

In an era of growing emphasis on teachers' accountability for their student outcomes in mathematics, this case study with a 4<sup>th</sup> grade teacher (Nora, pseudonym) examined possible links between a teacher's development of a constructivist-based, student-adaptive pedagogical (AP) approach and student outcomes. The study was conducted within our team's efforts to promote and study K-5 teachers' development of pedagogical perspectives and practices that revolve around and adapt to students' available conceptions. This paper focuses on how changes detected in Nora's understanding of and capitalizing on student thinking contributed to their improved outcomes on the Transitional Colorado Assessment Program (TCAP)—the state, annually mandated test in mathematics. Specifically, the study addressed the questions: (a) What shifts can be detected in a teacher's pedagogical understandings and practices to incorporate research findings about students' thinking and (b) how might these shifts contribute to student learning and outcomes? Nora chose to focus on teaching multiplicative reasoning because it constitutes a conceptual milestone for her fourth graders. In this domain, the Common Core State Standards (CCSS) (National Governors Association Center for Best Practices, 2010) emphasized students' learning to reason about and solve multiplicative, realistic (word) problems along with using algorithms to calculate 1-digit x 4-digit numbers as well as 2-digit x 2-digit numbers. Linking conceptual and procedural understandings in all children is vital not only for multiplicative reasoning but also as foundations for fractional, proportional and algebraic reasoning (Thompson & Saldanha, 2003).

## CONCEPTUAL FRAMEWORK

We consider teaching mathematics to be a goal-directed activity (Ernest, 1989) that involves teachers in promoting students' progress to ever more advanced ideas (Schifter, 1998). Thus, teacher perspectives of mathematical knowing and learning drive the goals for and ways they implement their activities in practice (Thompson, 1992). To account for teacher development, we use a 4-perspective framework (Table 1) that explicates a continuum of stances in teachers' thinking about math knowing, learning, and teaching (Jin & Tzur, 2011; Simon et al., 2000).

Perspectives	View of knowing	View of learning	View of teaching
Traditional (TP)	Independent of knower, out there	Learning is passive reception	Transmission; lecturing; <i>instructor</i>
Perception-based (PBP)	Independent of knower, out there	Learning is discovery via active perception	Teacher as <i>explainer</i> ('points out')
Progressive Incorporation (PIP)	Dialectically independent and dependent on knower	Learning is active (mental); known required as start; incorporate new into old	Teacher as <i>guide and engineer</i> of learning-conducive conditions
Conception-based (CBP)	Dynamic; depend on one's prior knowledge (assimilatory schemes)	Active construction of the new as transformation in the known (via reflection)	Engage in problem solving; Orient reflection; <i>Facilitator</i>

Table 1: Teacher perspectives on mathematics knowing, learning, and teaching

The AP (Steffe, 1990) is based on the conception-based perspective. It stresses a teacher's selection and use of mathematical goals and activities for student learning that are tailored, in every mathematics lesson, to students' resources—conceptions and experiences they have and bring to a learning situation as part of their funds of knowledge (Moll et al., 1992). The rationale is that learning a new mathematical idea entails transformation in conceptions available to the child (von Glasersfeld, 1995). Thus, a teacher needs to continually infer into their current reasoning—ways of operating with/on units—and set goals for changes in these operations/units that build on, challenge, and foster construction of the intended ones. We note that AP differs from the well-known CGI approach (Carpenter et al., 1989). CGI seems to equate a child's thinking with a task-structure an adult recognizes whereas AP distinguishes between the two (Tzur et al., 2013). To illustrate AP, we describe how a teacher may foster students' conceptual leap from additive to multiplicative reasoning (Behr et al., 1994), stressing that *their* operations on units may be effected but are not determined by tasks a teacher uses.

Reasoning multiplicatively requires using number as a composite unit—a “thing” made up of sub-parts—and coordinating distributing operations among such units (Steffe, 1992). Additive operations preserve such units (e.g.,  $5 \text{ dots} + 5 \text{ dots} + 5 \text{ dots} =$

15 dots), while multiplicative operations transform them (Schwartz, 1991) via distribution of items of one composite unit over the items of another composite unit to yield a third, different unit (e.g.,  $5 \text{ dots/page} \times 3 \text{ pages} = 15 \text{ dots}$ ). This key, content-specific notion of our conceptual framework is organized in a 6-scheme developmental sequence (Tzur et al., 2013) that, between multiplication and division (both quotitive and partitive), distinguishes three ways of operating on composite units. After establishing multiplicative double counting (*mDC*—the aforementioned operation on composite units), a child may advance to the *Same Unit Coordination (SUC)* scheme (finding sums/differences of compilations of composite units), then to a *Unit Differentiation and Selection (UDS)* scheme (noting differences/similarities among units of two compilations), and to a *mixed-unit coordination (MUC)* scheme (coordinating operations on composite units and 1s). The latter, with UDS as its predecessor, enables, for example, thinking about and meaningfully solving the following problem: “Juanita has 4 bags with 10 marbles each, and a box with 56 marbles. If she places the additional marbles in bags of 10, how many bags and how many marbles will she have in all?” Using the MUC scheme, a child may either reason from four 10s to forty 1s and add them to the 56 to yield 96 marbles, or from the 1s to 10s (“bags” as a composite unit) to divide the 56 and find five 10s and remaining six 1s, hence nine 10s + six 1s = 96 (note how the child “supplies” her way of operating; it is not task-determined).

## METHODOLOGY

We used a mixed-method approach, with quantitative (student scores on the TCAP test in mathematics) and qualitative (interview segments) providing the data to address the research questions. Participants in this study included one teacher (Nora), the students in her classroom who were not pulled into an accelerated math class ( $N=13$ ), and student aggregates at her school (over 85% ELL, 100% eligible for reduced/free lunch), district, and state levels. Restrictions on (not) presenting disaggregated student data from other 4th grade classrooms precluded comparing changes in Nora’s and other teachers’ work (and student outcomes) at her school. Thus, student outcomes are examined through comparison to publicly available data to illustrate a trend in student changes due to a teacher’s shift toward AP.

Quantitative data and analysis include aggregated reports about proficiency levels achieved by 4<sup>th</sup> graders on the TCAP. This standards-based, yearly assessment consisted of 69 items: 54 multiple-choice items (accounting for 54% of a student’s total score) and 15 constructed response items (44% of the score). Topics sampled by the test items included place-value (base-ten) system, multiples and factors, multiplication and division of 1- or 2-digit whole numbers, interpretation of data presented on a graph, and estimation of costs/change for purchased items (i.e., decimals in money). Our analysis juxtaposes proficiency levels attained by students (March, 2012 and 2013) in the four different groups (Nora, school, district, state) after controlling for comparable populations (ELL, lunch eligibility).

Qualitative data and analysis focus on Nora's rationale for teaching activities used in video-recorded lessons she co-planned and co-taught weekly with [Tzur]. These inquiries were part of reflective, post-lesson sessions. Each session started by asking Nora to explain specific aspects of the lesson, including the *mathematics as she understood it*, reasons for actions she took and changes from plans she made, and what she took as evidence for each student's understanding (sense making) of the intended mathematics. [Tzur] then added his analysis about student learning and understanding, particularly distinguishing units/operations *each individual student* seemed to use. A session then culminated with co-planning the next lesson, linking where different students seemed to be conceptually with curricular goals set for their next learning. Video segments that illustrate shifts in Nora's thinking were selected for the analysis (presented below).

## RESULTS

This section first reports on the comparison of aggregated, quantitative data among groups of participating students. This comparison points to the significance of Nora's shift toward AP. We note here that a key reason Nora gave for choosing to focus on multiplicative reasoning was her discontent with student learning and outcomes when, as often happens, teaching-learning processes consist mainly (or solely) of executing algorithms while using heavily-practiced, memorized facts. She noticed that her students might be (partially) successful in solving problems highly similar to those solved in class; but they failed to transfer multiplicative thinking to situations that deviated, even if only slightly, from those they solved previously. This indicated to Nora a lack of fundamental understandings needed to solve such problems by mindfully choosing/executing proper calculations. Student outcomes on the mathematics portion of the TCAP seem to support this focus.

### Student Outcomes

Figure 1 presents percentages of students who scored at the combined level of Proficient or Advanced (Pr+Ad), and how these outcomes changed from 2012 (before Nora fully implemented AP) and 2013 (post). At this desired proficiency level, her students improved from 58% to 85% (growth of 46%), as compared to school's increase from 46% to 60% (growth of 30%, figures include Nora's class due to aggregation), district's increase from 56% to 58% (4% growth), and no detectable change in state's averages (72% in both years).

These data indicate three important trends. First, a teacher versed in AP can bring the majority of her class (85%) to the Pr+Ad level. Specifically, Nora promoted three students' shift from PP to Pr and one from Pr to Ad. Second, Nora's students exceeded their comparable counterparts in terms of percentages scoring at Pr+Ad and growth from previous year. (Note: all higher-achieving students, pulled from her class and not included, attained at proficient or advanced levels.) Third, these data indicate closing the achievement gap between students from the typically underachieving sub-groups

and their white counterparts. Combined, these results suggest changes in Nora’s teaching (examined next) as a possible contributor.

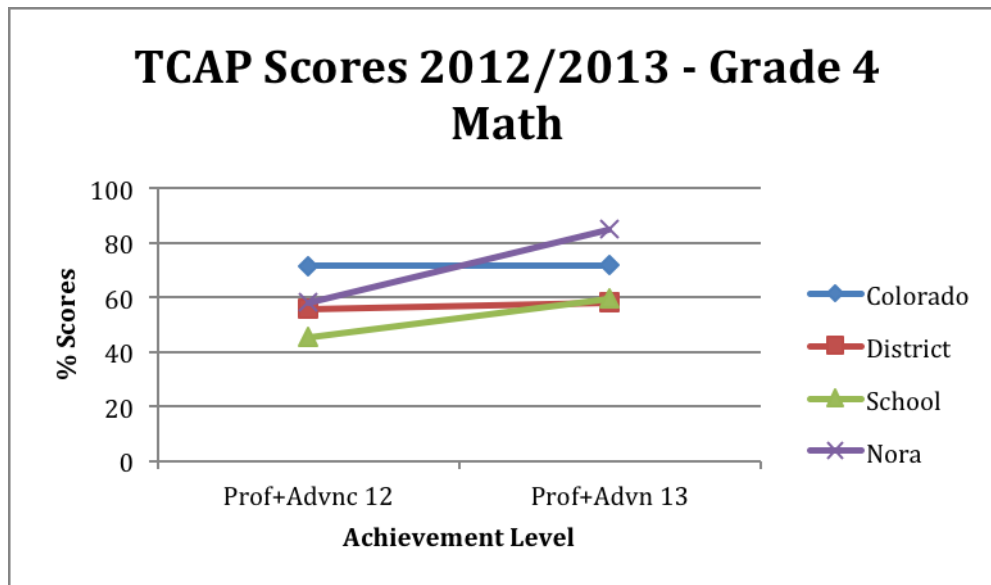

Figure 1: Proficient/Advanced Comparison 2012 to 2013

### Shifts in Nora’s Teaching

Shifts in Nora’s thinking about how her teaching should link to students’ learning are illustrated in three excerpts, two from fall 2011 and the third from spring 2012.

#### Excerpt 1: Early Fall 2011

Tzur: (Probes about how she used to teach multiplication.)

Nora: Previously we have had an introduction to multiplication. Which is hard for them because they memorize the facts but they have no idea why they do it. And it’s actually a struggle for a group of kids, because they know they are supposed to have memorized it, and they have no idea why. [A bit later, asked for an example.] We actually did study arrays in the first unit of Investigations and that was so hard for them. I had to bring in Cheez-its; I gave each [student] a bag of Cheez-its. So that they could build the factors necessary to get to their number [arrays] and that was [still] very difficult for them.

#### Excerpt 2: Fall 2011 (two weeks after the lesson discussed in Excerpt 1)

Tzur: (Asks about her assertion on differentiated attainment of the intended math.)

Nora: I think that there are some—that some students that are—I think it is about half and half. Half of the class, maybe a little more than half, are doing [operating on] 1s; the other half is counting in [composite] units.

#### Excerpt 3: Spring 2012

Tzur: (Asks about tasks *she planned* for students ready for UDS-to-MUC shift.)

Nora: I'll create a worksheet [of *realistic word problems*] that has to do with the Mixed Unit Coordination in multiplicative reasoning. I will start with 5s and 10s and then I am going to move to 4s and other numbers and then maybe I will do another [task] with 6, [or] 7, [or] 8; and then we can move on.

The three Excerpts indicate a shift in Nora's focus on and use of students' thinking. In Excerpt 1 she recognized some students might not have mastered multiplication facts and that everyone, those who did and those who did not, seemed to have no meaning for what is being memorization. She mentioned the use of a real-life manipulative (Cheez-its), which she decided to add when sensing the difficulties her students faced in learning about multiplication as a rectangular array. This is a typical teaching move informed by a Perception-Based Perspective—trying to help students “see” the mathematics she could see. Yet, during the entire post-lesson session (Excerpt 1 included), she did not explain nor link that manipulative to particular ways in which different students were operating to solve the problems.

In Excerpt 2 (two weeks later), she began distinguishing two sub-groups in her class in terms of different units on which they operated when solving problems. We note that later at the interview she also differentiated nature of these units: tangible, figural, or abstract (i.e., numbers). This distinction then played a role in her planning. She purposely designed activities to advance those students who were counting 1s to counting composite units as a necessary conceptual change in their operation via the unit-transforming distribution of items.

In the three months between Excerpt 2 and 3, Nora focused on inferring students' thinking by proactively using the 6-scheme framework and on using these inferences to guide her practice. Excerpt 3, shows a shift in her awareness of the role that those schemes could play in her teaching. When introducing a new, challenging concept such as MUC, the teacher needs to carefully select composite units (numbers) for the tasks she designs, so students could bring forth their available schemes (mDC, SUC, and UDS—as she mentioned earlier in the interview) and solve the problem while having an opportunity to transform those to the intended, MUC scheme. That is, Nora seemed to develop conscious attention to the link between her analysis of students' thinking and tasks that may be useful for the next lesson. Her comments suggest purposeful sequencing of tasks, and numbers used, as a means to moving forward while supporting students' reasoning.

## DISCUSSION

This paper focused on ways in which professional development of teachers of mathematics and their student outcomes may be linked. Particularly, it showed how a shift in a teacher's perspective changed her practice and student outcomes that seemed to follow from this change. The results of the study suggest two major contributions to the field. First, Nora's case points to the importance of teacher learning to (a) distinguish students' ways of thinking and (b) base her teaching practices on



research-based learning trajectories, such as the 6-scheme framework (Tzur et al., 2013). The notion of AP used to guide Nora's development entails the need to help a teacher clearly differentiate her own mathematics from the students' ever-changing mathematical schemes, which is consistent with Steffe's (1990) distinction between 1<sup>st</sup> and 2<sup>nd</sup> order models, respectively. Nora's case indicates a teacher can surmount the challenge involved in making such a distinction and purposely use accounts of cognitive change to inform her instruction daily. It also raises issues for future studies, including how the intensive nature of co-teaching that promoted Nora's development may be implemented on a larger scale. This study provides a first glimpse into how mathematics educators and classroom teachers can work collaboratively to bring about this desired shift.

Second, the comparison of quantitative data of proficiency levels attained by Nora's students and their counterparts (school, district, state) indicates the potential benefits of a shift toward a student-adaptive pedagogy. Mathematics education literature, particularly since reform pedagogies and materials were introduced (Senk & Thompson, 2003), showed that student outcomes when learning in reform classrooms were not compromised. A typical claim would be that students in those classrooms did not do worse than their counterparts in more traditional classrooms. However, this study, along with data about other classes in Nora's school (and other districts) that we continue collecting and analyzing provide further evidence that a shift to adaptive teaching may promote bona fide improvement in student outcomes. We contend that the improvement in student outcomes presented in this paper were made possible by the teacher's learning to use their ways of thinking as a driving force in creating (and adjusting) lessons conducive to their learning. Simply put, *opportunities* to learn are afforded (or constrained) by what students know. Clearly, further research is needed to more specifically link between the teacher's development of conceptual/practical tools implied by AP and growth in students' learning, reasoning, problem solving, and tested outcomes.

## References

- Carpenter, T. P., Fennema, E., Peterson, P. L., Chiang, C. P., & Loef, M. (1989). Using knowledge of children's mathematics thinking in classroom teaching: An experimental study. *American Educational Research Journal*, 26(4), 499-531.
- Ernest, P. (1989). The knowledge, beliefs and attitudes of the mathematics teacher: A model. *Journal of Education for Teaching*, 15, 13-33.
- Jin, X., & Tzur, R. (2011). *Progressive incorporation of new into known: A perspective on and practice of mathematics learning and teaching in China*. Paper presented at the Annual Conference of the Association of Mathematics Teacher Educators, Irvine, CA.
- Moll, L. C., Amanti, C., Neff, D., & Gonzalez, N. (1992). Funds of knowledge for teaching: Using a qualitative approach to connect homes and classrooms. *Qualitative Issues in Educational Research*, 31(2), 132-141.

- National Governors Association Center for Best Practices. (2010). *Common core state standards initiative*. Washington, DC: NGA & CCSSO.
- Schifter, D. (1998). Learning mathematics for teaching: From a teachers' seminar to the classroom. *Journal of Mathematics Teacher Education*, 1(1), 55-87.
- Schwartz, J. L. (1991). Intensive quantity and referent transforming arithmetic operations. In J. Hiebert & M. J. Behr (Eds.), *Number concepts and operations in the middle grades* (3<sup>rd</sup> ed., Vol. 2, pp. 41-52). Reston, VA: National Council of Teachers of Mathematics.
- Senk, S. L., & Thompson, D. R. (2003). *Standards-Based School Mathematics Curricula: What Are They? What Do Students Learn?* Mahwah, NJ: Lawrence Erlbaum.
- Simon, M. A., Tzur, R., Heinz, K., Kinzel, M., & Smith, M. S. (2000). Characterizing a perspective underlying the practice of mathematics teachers in transition. *Journal for Research in Mathematics Education*, 31(5), 579-601.
- Steffe, L. P. (1990). Adaptive mathematics teaching. In T. J. Cooney & C. R. Hirsch (Eds.), *Teaching and learning mathematics in the 1990s* (pp. 41-51). Reston, VA: National Council of Teachers of Mathematics.
- Steffe, L. P. (1992). Schemes of action and operation involving composite units. *Learning and Individual Differences*, 4(3), 259-309. doi: 10.1016/1041-6080(92)90005-Y
- Thompson, A. G. (1992). Teachers' beliefs and conceptions: A synthesis of research. In D. A. Grouws (Ed.), *Handbook of research on mathematics teaching and learning* (pp. 127-146). New York: Macmillan.
- Thompson, P. W., & Saldanha, L. (2003). Fractions and multiplicative reasoning. In J. Kilpatrick & G. Martin (Eds.), *Research companion to the NCTM Standards* (pp. 95-113). Washington, DC: National Council of Teachers of Mathematics.
- Tzur, R., Johnson, H. L., McClintock, E., Kenney, R. H., Xin, Y. P., Si, L., . . . Jin, X. (2013). Distinguishing schemes and tasks in children's development of multiplicative reasoning. *PNA*, 7(3), 85-101.
- von Glasersfeld, E. (1995). *Radical constructivism: A way of knowing and learning*. Washington, DC: Falmer.

# HOW IS THE FUNCTION CONCEPT INTRODUCED IN TEXTBOOKS?: A COMPARATIVE ANALYSIS

Dae S. Hong, Kyong Mi Choi

University of Iowa

*This study compared sections of functions and linear functions from four Korean textbooks and Core Plus Mathematics Project (CPMP). To understand differences and similarities among these textbooks, both horizontal and vertical analyses were conducted. The horizontal analysis results revealed that topics related to functions and linear functions are introduced relatively earlier in Korean textbooks than in CPMP. The vertical analysis results confirmed the findings of previous study (Hong & Choi, 2014), which can be interpreted as “textbook signature”.*

## INTRODUCTION

Reports from international comparative studies such as Trend in International Mathematics and Science Study (TIMSS) and Programme for International Student Assessment (PISA) indicates that East Asian students perform consistently well. Among the various areas of mathematics education research, textbooks play an important role in determining what is taught and what students learn. There are different views of textbooks, however, researchers agree, in various degrees, that an analysis of textbooks can partially explain differences in student achievement (Zhu & Fan, 2006). Although Korea is one of the high achieving countries in international assessments, there are few mathematics education studies that disseminate Korean secondary mathematics textbooks (Hong & Choi, 2014). “Lesson signature” and “textbook signature” are distinctive characteristics across lessons and textbooks in each country (Hiebert et al., 2003; Charalambous, Delaney, Hui-Yu & Mesa, 2010). Such characteristics could partially explain what students in different countries learn. By comparing textbooks, this study will examine features of secondary Korean and American mathematics textbooks. If some features are consistently found, we can say that there is “textbook signature” among Korean and American secondary textbooks. We chose one of the fundamental and central unifying concepts in mathematics, the concept of functions (up to the linear functions) for comparison (Eisenberg, 1992; National Council of Teachers of Mathematics [NCTM], 1989, p. 154). Here are research questions that we attempt to answer:

1. What similarities and differences are observed in the content of function lessons of Korean and standards –based American secondary textbooks?
  - i) How are topics of function introduced and developed?
  - ii) What practices and contexts are used in the mathematics problems?
2. What types of responses and levels of cognitive demands are required in the textbook problems?

## LITERATURE REVIEW

### Students' Learning of Function

Studies show the formal definition of a function, the Dirichlet–Bourbaki definition is introduced often, but there are various misconceptions about a function: a function is defined by an algebraic formula, a function must be continuous, and a split domain will represent more than one function (Hitt, 1998; Mesa, 2004). To overcome misconceptions, multiple representations are often emphasized (Brenner et al., 1997).

### Textbook Comparison Studies

Studies show that Asian countries' textbooks (Japan and Taiwan) contain more mathematical topics in one school year and introduce these topics earlier in the sequence of the school year compared to both elementary and secondary American textbooks (Stevenson & Bartsch, 1992; Stigler et. al., 1982). In analyses of mathematics problems, studies have presented varying results. Some have shown that in both elementary and secondary mathematics textbooks, Asian countries contain more challenging problems and problems requiring explanation than American standards–based and traditional textbooks (Li, 2000; Son & Senk 2010) while other studies discovered that standards–based textbooks include more challenging problems and problems requiring explanation than traditional and Korean secondary textbooks (Cai, Nie, & Moyer, 2010; Hong & Choi, 2014).

## METHODOLOGY

### Framework

A two-dimensional framework, *horizontal* and *vertical* analyses, was employed (Charalambous et al., 2010). A *horizontal* analysis provides background information on the textbook development, the number of lessons and grade level placement of certain topics. A *vertical* analysis provides in-depth understanding textbook content including how the lesson begins and concepts are developed (Table 1)

Horizontal Analysis	Vertical Analysis
Education systems	Introduction and development of topics
Number of lessons	Cognitive demands of problems
Number of problems	Type of responses
Grade level placement of topics	Practices used

Table 1: Framework for Textbook Analysis of Content and Problems

The vertical analysis is also used for the problem analysis, which consists of three dimensions – cognitive demands, response type, and practices used. To investigate the cognitive demand of problems, we adopted the *Task Analysis Guide* by Stein, Grover, and Henningsen (1996). Codes of M (Memorization) and P (Procedures without Connections) are considered lower-level demands and PC (Procedures with Connections) and DM (Doing Mathematics) are higher-level demands. Response type of each problem was examined to determine whether the mathematics problem

requires students to provide only an answer (numerical, algebraic expressions or graph) or explain or process and justify their reasoning. The last part of the problem analysis is based on various practices described in literature about functions. Symbolic rule, social data, physical phenomenon, and ordered pairs are practices seen in previous studies (Hitt, 1998; Mesa, 2004).

### **Data: Textbook Selection and Background**

Two courses of standards-based American mathematics Core Plus Mathematics Project (CPMP) textbooks – Course 1 and Course 2 – were chosen for analysis. For the Korean textbooks, Middle School Mathematics 1 and 2 by Dusan and Jihak Publishings, were selected. In addition, the curriculum guidelines from the Korean Ministry of Education (MOE) and Common Core State Standards – Mathematics (CCSS-M) were also examined. U.S. Department of Education and called CPMP an exemplary mathematics program in 1999. A recent report from the Indiana Department of Education (2011) states that CPMP is aligned well with the CCSS–M.

### **Reliability of Coding**

For coding reliability, the two authors, fluent in both English and Korean, independently coded each problem in the textbooks. Next, a third rater, a doctoral student in mathematics education, randomly chose one textbook from each country and independently coded each problem. When the two authors disagreed, those items were coded based on majority rule using the third rater's codes. There were no items in which all three raters disagreed. The percent agreement of the three raters was between 88% and 93%. In all, there are 459 problems in the four Korean textbooks and 513 problems in the CPMP are analyzed and coded.

## **RESULTS**

### **Horizontal Analysis**

In Korea, there are two kinds of textbooks in Korea – government *published* and government *authorized* textbooks (Korean Textbook Research Foundation [KTRF], 1998). Whether they are government published or authorized, the content in all textbooks are almost identical. Each state or district determines school curricula in the U.S. Instead of government agencies, professional organizations such as NCTM provide curriculum guidelines and standards (NCTM, 1989). During the so-called standards era of the 1990s, the National Science Foundation and other organizations funded many curriculum development projects in the U.S. which resulted in several 'standards-based' mathematics curricula.

CPMP includes nine lessons on the topic of function and linear functions while the Korean textbooks have eleven lessons. Korean textbooks include two more lessons, but it is difficult to say that Korean students learn more topics because all content of these two lessons are included in CPMP. CPMP is designed for grades 9 to 11 (Schoen & Hirsch, 2003b), while the Korean textbooks are for grades 7 and 8. The CCSS–M recommends topics of functions be introduced in grade 8. This means Korean students

learn the concept of function relatively earlier compared to CPMP students. In total, there are 459 and 513 problems in the four Korean and CPMP textbooks, respectively: 20.8 problems per lesson in Korea and 57 problems per lesson in CPMP. This result is contrast to a result of Son and Senk’s (2010) study comparing elementary textbooks while coinciding with a result from a study comparing secondary school textbooks (Hong & Choi, 2014).

### Vertical Analysis

In this section, we briefly how these textbooks introduce the concept of a variable. How textbooks introduce the concept of a variable is closely related to how the concept of function are developed. A variable is defined as *unknown* in textbooks and curriculum guidelines from the Korean MOE while CPMP uses variables to describe linear patterns/functions/equations, meaning that it is something that changes. Korean textbooks’ static approach, which is also found in traditional American textbooks, is called a structural approach while CPMP’s approach to linear functions is a functional approach (Cai et al., 2010).

### The concept of function

Differences between the two countries’ textbooks are observed from the very first lesson. At the end of the first unit in CPMP course 1, Patterns of Change, CPMP defines a function in the following way:

In mathematics, relations like these – where each possible value of one variable is associated with exactly one value of another variable – are called functions (Hirsch et al., 2007a, p. 69).

This definition is given immediately after a description of a bungee cord being attached to one weight, real-world application. Figure 1 shows problems in the lesson. Aside from problem 4-a, these problems require students to reason, think, and explain their thoughts and reasoning, simple algorithms or computations will not be enough.

**Buying on Credit** Electric Avenue sells audio/video, computer, and entertainment products. The store offers 0% interest for 12 months on purchases made using an Electric Avenue store credit card.

4 Emily purchased a television for \$480 using an Electric Avenue store credit card. Suppose she pays the minimum monthly payment of \$20 each month for the first 12 months.

a. Complete a table of (*number of monthly payments, account balance*) values for the first 6 months after the purchase, then plot those values on a graph.

Number of Monthly Payments	0	1	2	3	4	5	6
Account Balance (in dollars)							

b. Will Emily pay off the balance within 12 months? How do you know?

c. If you know Emily’s account balance *NOW*, how can you calculate the *NEXT* account balance, after a monthly payment?

Figure 1: First few problems about in CPMP (Hirsch et al., 2007 a, p. 152).

The following is the definition found in Korean textbooks:

For two variables  $x$  and  $y$ , if there is one corresponding  $y$  value for  $x$  value,  $y$  is called a function of  $x$  and it can be written symbolically in the following way,  $y = f(x)$ . (Lee et al., 2008, p. 131)

After the definition of a function, a formal definition of domain and range of a function is followed (Figure 2) and these terms are not introduced in CPMP. Formally defining function and introducing domain and range suggests that the Korean textbooks' approaches are structural.

함수  $y=f(x)$ 에서 변수  $x$ 의 값을 나타내는 수 전체의 집합을 **정의역**이라 하고, 변수  $y$ 의 값을 나타내는 수 전체의 집합을 **공역**이라고 한다.

Translation: For a function  $y = f(x)$ , the collection of all possible  $x$  values is called the **Domain** and the collection of all possible  $y$  values is called the **Range**.

Figure 2: Domain and Range in Korea textbook (Lee et al., 2008, p. 133).

### Rate of change, slope and ordered pairs

After solving five real-life context problems, CPMP introduces the concept of slope using physical phenomenon to show rate of change. On the other hand, the Korean textbooks maintain their focus on symbolic and pure mathematical approaches. Their next topic are ordered pairs, coordinate plane and sketching the graph of  $y = ax$ . On the last lesson about linear function in Middle School Mathematics 1, the Korean textbooks introduce some real-life applications, but differ from the CPMP because the problems require procedures of finding an equation and computing a number for a “real-life” value without requiring explanations.

CPMP's emphasis on real-life applications can be seen in Figure 3. For example, part b requires students to explain the meaning of a positive or negative slope in a realistic context of depreciation and inflation.

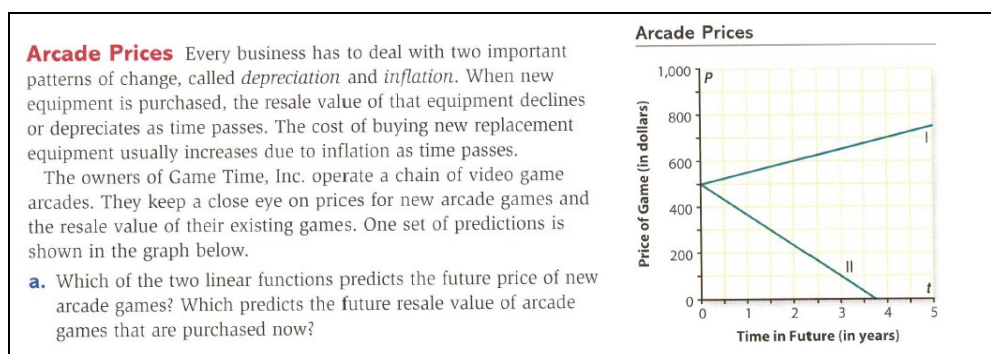

Figure 3: Slope in a real-life context (Hirsch et al., 2007 a, pp. 158-159).

### Cognitive Demands of Problems

CPMP includes more problems with higher level cognitive demands (PC and DM) than the Korean textbooks – 25.7 % in CPMP and 7.4% in Korean. The majority of problems – 74.3% of problems for CPMP and more than 90% for the Korean textbooks – require low cognitive demand (M and P).

### Response Type

Over 90% of problems in the Korean textbooks require number, expression, or graph-type responses. One remarkable difference is that more than 40% of problems in

CPMP require explanations compared to only 6.5% of problems in the Korean textbooks. These results, cognitive demands response type, are consistent with previous study (Hong & Choi, 2014), which can possibly be interpreted as “textbook signature.”

### **Practices Used**

Symbolic practice is the most frequent type for both Korean (43.2%) and CPMP (37.4) textbooks, which was also found in a previous study (Mesa, 2004). The notable difference between the two countries’ textbooks is the portion of real-life problems (Social Data and Physical Phenomena): 56.1 % in CPMP and 16.5 % in Korean textbooks.

### **DISCUSSION AND CONCLUSIONS**

This article compared sections of functions and linear functions from four Korean textbooks and CPMP. The horizontal analysis results revealed that topics related to functions and linear functions are introduced relatively earlier in Korean textbooks than in CPMP, which confirms findings in previous studies (Stevenson & Bartsch, 1992). The vertical analysis results demonstrate that CPMP places strong emphasis on real-life applications rather than pure mathematics, a functional approach while the Korean textbooks emphasize symbolic and algebraic representations, a structural approach. A majority of problems in both the CPMP and Korean textbooks only require lower level cognitive ability in contrast to the results of previous studies about textbooks of East Asian countries (Charalambous et al., 2010; Son & Senk, 2010). However, this outcome corresponds with a finding from Hong and Choi (2014) and these characteristics can be considered “textbook signature” among Korean secondary mathematics textbooks.

This study yields results, which both contradict and confirm previous findings: CPMP, the American standards-based curriculum, offers more opportunities for students to solve, explain, and reason about higher level cognitive demanding mathematics problems than Korean secondary textbooks. This conflicts with American students’ mediocre performances on international comparative studies because CPMP students can possibly engage in more meaningful and interesting tasks when learning mathematics. Our results confirm the well-known fact that the link that connects what textbooks potentially offer and what students learn is what teachers do and how they implement textbook content in their classes. Further studies on how teachers in different countries implement and use curriculum materials may explain the gap between what textbooks offer and students’ performances. Because of contradicting results, Hong and Choi (2014) state that textbooks may not be the reason for American and Korean students’ performances on international comparative studies. Our results confirm their assertion that CPMP students have several opportunities to reason, solve, and think about mathematics problems. Although we cannot generalize our results, properly implementing these textbooks in mathematics classes may be the key to improving students’ performance in international studies.



In terms of the contents of these textbooks, each country's textbook may need to equally include various function practices. Korean students may struggle with real-life contexts of functions while CPMP students may have difficulty with symbolic and algebraic representations of the function concept. Textbook publishers and authors should consider distributing other representations and practices equally.

Further studies to measure “lesson signature” and “textbook signature” may be interesting as well. A previous criticism of American mathematics curriculum is the incoherent mathematics curriculum among different states (Schmidt et al., 2001). If there exists “textbook signature” among other standards-based textbooks, we can have a more coherent mathematics curriculum.

## References

- Brenner, M., Mayer, R., Moseley, B., Brar, T., Durán, R., Smith Reed, B., & Webb, D. (1997). The role of multiple representations in learning algebra. *American Educational Research Journal*, 34(4), 663-689.
- Cai, J., Nie, B., & Moyer, J. C. (2010). The teaching of equation solving: Approaches in standards-based and traditional curricula in the United States. *Pedagogies: An International Journal*, 5, 170-186.
- Charalambous, C., Delaney, S., Hsu, H.-Y., & Mesa, V. (2010). A comparative analysis of the addition and subtraction of fractions in textbooks from three countries. *Mathematical Thinking and Learning*, 12, 117-151.
- Eisenberg, T. (1992). Functions and associated learning difficulties, In D. Tall (Ed.), *Advanced mathematical thinking* (pp. 140-152). Dordrecht: Kluwer Academic.
- Fan, L., & Zhu, Y. (2007). Representation of problem-solving procedures: A comparative look at China, Singapore, and US mathematics textbooks. *Educational Studies in Mathematics*, 66, 61-75.
- Hiebert, J., Gallimore, R., Garnier, H., Givvin, K. B., Hollingsworth, H., Jacobs, J. K., ... Stigler, J. (2003). *Teaching mathematics in seven countries: Results from the TIMSS 1999 videostudy* (NCES 2003-013 Revised). Washington, DC: U.S. Department of Education, National Center for Education Statistics.
- Hirsch, C. R., Fey, J. T., Hart, E. W., Schoen, H. L., & Watkins, A. E. (2007). *Core-Plus Mathematics: Contemporary mathematics in context, Course 1*. Columbus, OH: Glencoe/McGraw-Hill.
- Hitt, F. (1998). Difficulties in the articulation of different representations linked to the concept of function. *Journal of Mathematical Behavior*, 17(10), 123-134.
- Hong, D., & Choi, K. (2014). A comparison of Korean and American secondary school textbooks: The case of quadratic equations. *Educational Studies in Mathematics*, 85(2), 241-263.
- Indiana Department of Education. (2011). *Mathematics – Integrated mathematics I-III curricular materials*. Retrieved from <http://www.doe.in.gov/achievement/curriculum/mathematics-integrated-mathematics-i-iii-curricular-materials>

- Kang, O., et al. (2009). *Joonghakyo Soohak 1* [Middle School Mathematics 1]. Seoul, Korea: Dusan Publishing Co.
- Korean Textbook Research Foundation. (1998). *A study on making list of all textbooks published in Korea since 1945 and studying how to collect these textbooks*. Seoul, Korea.
- Kramer, S. L., & Keller, R. (2008). A brief report: An existence proof: Successful joint implementation of the IMP curriculum and a 4 x 4 block schedule at a suburban U.S. high school. *Journal for Research in Mathematics Education*, 39, 2-8.
- Lee, K., Wang, K., Song, K., Lee, K., & Ahn, I. (2008). *Joonghakyo Soohak 1* [Middle School Mathematics 1]. Seoul, Korea: Jihak Publishing Co.
- Li, Y. (2000). A comparison of problems that follow selected content presentations in American and Chinese mathematics textbooks. *Journal for Research in Mathematics Education*, 31, 234-241.
- Mesa, V. (2004). Characterizing practices associated with functions in middle school textbooks: An empirical approach. *Educational Studies in Mathematics*, 56, 255-286.
- Ministry of Education in Korea. (2007). *The 7<sup>th</sup> national mathematics curriculum*. Seoul, Korea: Author.
- National Council of Teachers of Mathematics. (1989). *Curriculum and evaluation standards for school mathematics*. Reston, VA: Author.
- Schmidt, W. H., McKnight, C. C., Houang, R. T., Wang, H. C., Wiley, D. E., Cogan, L. S., & Wolfe, R. G. (2001). *Why schools matter: A cross national comparison of curriculum and learning*. San Francisco, CA: Jossey-Bass.
- Son, J., & Senk. S. (2010). How standards curricula in the USA and Korea present multiplication and division of fractions. *Educational Studies in Mathematics*, 74, 117-142.
- Stein, M. K., Grover, B. W., & Henningsen, M. (1996). Building student capacity for mathematical thinking and reasoning: An analysis of mathematical tasks used in standards classrooms. *American Educational Research Journal*, 33, 455-488.
- Stevenson, H. W., & Bartsch, K. (1992). An analysis of Japanese and American textbooks in mathematics. In R. Leetsman & H. J. Walberg (Eds.), *Japanese educational productivity* (pp. 103-134). Greenwich, CT: JAI Press.
- Stigler, J. W., Lee, S.-Y., Lucker, G. W., & Stevenson, H. W. (1982). Curriculum and achievement in mathematics: A study of elementary school children in Japan, Taiwan, and the United States. *Journal of Educational Psychology*, 74, 315-322.
- Vinner, S., & Dreyfus, T. (1989). Images and definitions for the concept of function. *Journal for Research in Mathematics Education*, 20(4), 356-366.
- Zhu, Y., & Fan, L. (2006). Focus on the representation of problem types in intended curriculum: A comparison of selected mathematics textbooks from mainland China and the United States. *International Journal of Science and Mathematics Education*, 4, 609-626.

# THE IMPORTANCE OF ACHIEVING PROFICIENCY WITH SIMPLE ADDITION

Sarah Hopkins<sup>1</sup>, Donna Bayliss<sup>2</sup>

<sup>1</sup>Monash University, <sup>2</sup>University of Western Australia

*In this study we investigated how 200 students in seventh grade (mean age = 12.38 years) solved simple addition problems and if the way they performed simple addition was related to their achievement in mathematics. Four performance groups were identified: proficient, almost proficient, inaccurate min counting and accurate min counting. More than half the participants did not display proficient or close to proficient performance despite expectations that proficiency is achieved around third grade. Findings unique to this study were that accurate min counting was associated with lower math achievement and that girls were more likely to display this pattern of performance than boys. The findings corroborate a growing awareness that many students are not achieving proficiency and that this is a concern requiring attention.*

## INTRODUCTION

Simple addition involves adding together single digit numbers. Curriculum documents (or standards) indicate that by around second or third grade (eight years of age), children solve simple addition problems using retrieval (e.g., Australian Curriculum, Assessment and Reporting Authority, 2010; Department for Education, 2013; National Council of Teachers of Mathematics, 2000). Contrary to curriculum expectations, a large study conducted in the UK found that not just a few but *many* children in second and third grade were not retrieving solutions to most simple addition problems (Cowan, Donlan, Shepherd, Cole-Fletcher, Saxton, & Hurry, 2011).

It is not clear if educators need to be concerned about this finding. Cowan et al. (2011) postulated that a lack of retrieval with simple addition may not be the barrier to achievement that it is often predicted to be given children in their study also showed typical achievement. In this study we investigated how students who were well beyond the stage when retrieval is expected to dominate performance solved simple addition problems and if an association between simple addition performance and math achievement was evident among students who were expected to learn higher-order mathematical procedures and concepts.

## BACKGROUND

The issue regarding the importance of retrieval is somewhat clouded by different views of what it means to achieve *proficiency with simple addition*. Curriculum documents tend to view proficiency as the accurate and exclusive use of retrieval to solve simple addition problems. Retrieval refers to the direct retrieval of an answer from a store of facts held in long term memory (Ashcraft, 1995). Proficiency can also be viewed as

encompassing the correct use of other efficient strategies, not just retrieval (Baroody, 2006). These include *decomposition strategies*, strategies that involve applying number principles, deriving answers from related facts or decomposing numbers to solve problems (Cowan et al., 2011). Proficiency with simple addition is defined in this paper to be performance that is accurate and is dominated by the use of retrieval and decomposition strategies.

Before proficiency is achieved, children's simple addition performance is characterized by the use of counting strategies. As children develop in their mathematical thinking they generally progress from using a *counting-all strategy* where the count is started at one, to using more sophisticated counting strategies such as a *counting-on from first strategy*, where the second addend is counted on the first addend, and a *counting-on from larger strategy*, where the smaller addend is counted on the larger addend (Carpenter & Moser, 1984). The counting-on from larger strategy requires the minimum number of counts and is also referred to as *min counting* (Fuchs, Powell, Seethaler, Cirino, Fletcher, Fuchs, et al., 2010; Geary, Hamson, & Hoard, 2000). With continued correct practice (Shrager & Siegler, 1998) and growth in an understanding of number principles and rules (Baroody & Tiilikainen, 2003), children generally progress from using less efficient counting strategies to using min counting, retrieval and decomposition strategies (Hopkins & Lawson, 2002).

While min counting is the most efficient counting strategy, its frequent use is not considered appropriate beyond third grade in most curriculum documents. The issue regarding the importance of achieving proficiency with simple addition it is not about whether children's performance is dominated by retrieval, or retrieval and decomposition strategies, the issue is that children's performance is accurate and is no longer dominated by counting strategies including min counting.

This research is concerned with investigating the importance of achieving proficiency with simple addition. The first aim of this research was to document how students who were at a stage well beyond when proficiency is expected, performed simple addition. Students in Year 7 were chosen as this is the final year before secondary education in the state. The second aim was to investigate if the way students performed simple addition was related to their achievement in mathematics. The third aim was to explore possible gender differences in how simple addition was performed.

## **METHOD**

The study cohort comprised 200 students in Year 7 with a mean age of 12.38 years ( $SD=0.43$  years) from 13 government primary schools located in the Perth metropolitan area in Western Australia (WA). Participants included 116 females (58%). Mathematics achievement scores for each participant were based on numeracy results from the Western Australian Literacy and Numeracy Assessment (WALNA) administered by the government as part of the national testing regime. The numeracy section of the WALNA assesses math outcomes associated with Space, Measurement, Chance and Data, Number, Pre-algebra and Working Mathematically and takes

approximately 45 minutes to complete. Assessment results for the WALNA are calibrated on a common logit scale based on the Rasch measurement model and scores range from 0 to 800. The numeracy assessment used showed excellent reliability (Pearson Separation Index = 0.879). Numeracy scores for the study cohort did not differ significantly from the state's population mean score,  $t(196)=.219, p=.827$ .

Students were individually assessed as they performed a set of 36 simple addition problems that were presented in random order using a computer. The set included all single-digit addition problems with addends greater than 1 (2+2 to 9+9), written in the form 'm+n=' and presented with the smaller addend first (except for tie problems where m=n) making it possible to distinguish between use of the counting-on from first strategy and min counting. The response time taken to complete each problem was recorded along with the answer given. Strategy use was identified based on a combination of observation and self-report given after each problem was solved. This combined approach of observation and self-report on a problem by problem basis is commonly used to identify the strategies used to solve addition problems (e.g., Canobi, 2009; Geary et al., 2000).

Response times (RT) corroborated the strategies identified using the combined approach. Response times to retrieval trials were generally under three seconds ( $M=1.78s, SD=0.84$ ) - a time limit often used to infer direct retrieval on forced retrieval tasks (Cowan et al., 2011). Mean response times to trials where decomposition strategies were identified ( $M=3.26s, SD=1.8$ ) were longer than RTs to retrieval trials but shorter than RTs to min counting trials ( $M=3.76, SD=2.25$ ). Furthermore, RTs to min counting trials increased in a strong linear fashion as the minimum addend increased (representing the number of counts made). An increase of around half a second was recorded for each count.

Simple addition performance was classified into groups using cluster analysis based on three criteria similar to those used by Siegler (1988): the percentage use of direct retrieval, the percent correct on direct retrieval trials and the percent correct on min counting trials. An ANOVA was used to test group differences in terms of math achievement and a chi-square statistic was applied to test the significance of differences in the number of female and male students in each group.

## RESULTS

The three criteria significantly differentiated three performance groups: percentage use of direct retrieval,  $F(2,169)=176.50, p<.001, \eta^2=.67$ , percent correct on min counting trials,  $F(2,169)=161.61, p<.001, \eta^2=.66$ , and percent correct on direct retrieval trials  $F(2,169)=6.03, p<0.01, \eta^2=.07$ . Twenty-eight students could not be classified using the cluster analysis as they exclusively applied retrieval and decomposition strategies and therefore no data were available for the criterion relating to min counting trials. These students formed a fourth group.

The four performance groups appeared readily interpretable and were labelled the proficient, almost proficient, inaccurate min counting, and accurate min counting groups. The characteristics of students' simple addition performance for each of the four groups are detailed in Table 1, including the percentage mix of strategies used to solve the problem set and the percentage accuracy of each strategy.

	Proficient (n=28)	Almost proficient (n=65)	Inaccurate min counting (n=37)	Accurate min counting (n=70)
<u>Strategy</u>	<u>Mean strategy use (SD)</u>			
Direct retrieval	88.9% (11.5)	76.7% (10.6)	61.8% (10.7)	39.7% (12.6)
Min-counting	0	16.8% (9.7)	28.3% (13.7)	47.3% (18.9)
Decomposition	11.0% (11.5)	6.2% (8.7)	8.8% (9.8)	12.9% (14.3)
<u>Strategy</u>	<u>Mean accuracy (SD)</u>			
Direct retrieval	98.8% (2.3)	98.6% (2.5)	96.3% (4.7)	98.5% (3.6)
Min-counting	-	99.3% (3.0)	74.7% (10.5)	95.7% (7.1)
Decomposition	97.3% (5.19)	91.9% (24.1)	94.9% (12.7)	96.5% (9.7)

Table 1: Characteristics of each performance group

In summary, the simple addition performances of students characterized as proficient comprised the exclusive use of retrieval and decomposition strategies and mostly correct answers. Performance characterised as almost proficient was dominated by the accurate use of retrieval and decomposition strategies, but some accurate use of min counting was evident. Performance characterized as inaccurate min counting encompassed a relatively moderate use of direct retrieval and decomposition strategies, and the frequent use of min counting that resulted in incorrect answers (errors were made on 25% of min counting trials). Students in this performance group also displayed the lowest accuracy for retrieval. This finding is consistent with the strategy choice model (Shrager & Siegler, 1989), which predicts that retrieval errors can occur as incorrect associations are formed in memory when a counting strategy is used inaccurately. Performance characterised as being accurate min counting encompassed the dominant use of min counting and generally accurate performance.

The math achievement scores for students in each of the four performance groups were compared. Four students did not have achievement scores and were dropped from the analysis. An ANOVA revealed a significant difference in mean math achievement scores across performance groups,  $F(3,192)=15.84$ ,  $p<.001$ ,  $\eta^2=.20$ . Approximately 20% of variance in math achievement scores was explained by differences in how students performed simple addition. Post-hoc comparisons with Bonferroni adjustment revealed that students in the proficient group scored significantly higher on the math assessment ( $M=529.33$ ,  $SD=72.89$ ,  $n=27$ ) than students in the accurate min counting

group ( $M=451.09$ ,  $SD=71.37$ ,  $n=69$ ),  $t(94)=4.80$   $p<.001$ ,  $d=1.09$ , and students in the inaccurate min counting group ( $M=430.32$ ,  $SD=65.50$ ,  $n=37$ ),  $t(62)=5.69$ ,  $p<.001$ ,  $d=1.44$ . No significant difference in mean math scores was found between students in the proficient group and the almost proficient group,  $t(88)=1.94$ ,  $p=ns$ . Students displaying almost proficient performance scored significantly higher on the math assessment ( $M=498.54$ ,  $SD=67.12$ ,  $n=63$ ) than students who displayed accurate min counting  $t(130)=3.93$ ,  $p<.001$ ,  $d=0.68$ , and students who displayed inaccurate min counting,  $t(98)=4.95$ ,  $p<.001$ ,  $d=1.03$ . No significant difference in math achievement was found between students in the accurate min counting and inaccurate min counting groups,  $t(104)=1.47$ ,  $p=ns$ . The findings indicate that students who were more likely to solve simple addition problems using min counting displayed lower achievement in maths than their peers who frequently use retrieval and decomposition strategies – regardless of whether they use min counting accurately or inaccurately.

An exploratory analysis was also conducted to compare the number of female and male students classified as displaying proficient, almost proficient, inaccurate min counting and accurate min counting. Table 2 shows the number of female and male students in each group.

Performance group	No. of female students	No. of male students
Proficient	12 (10.3%)	16 (19.0%)
Almost proficient	30 (25.9%)	35 (41.7%)
Inaccurate min counting	21 (18.1%)	16 (19.0%)
Accurate min counting	53 (45.7%)	17 (20.2%)

Table 2: Number of female and male students in each performance group

The chi-square statistic indicated that there was a significant difference in the gender composition of the performance groups,  $\chi^2(3, N=200) = 15.421$ ,  $p = .001$ . More female students displayed accurate min counting performance than male students, and more male students displayed proficient or almost proficient performance than female students. A comparable number of male and female students displayed inaccurate min counting.

## DISCUSSION

The findings revealed that less than half the number of Year 7 students who participated in the study were proficient or close to being proficient with simple addition. As students were well beyond the stage when proficiency is expected, this finding highlights the issue that many students are not achieving proficiency with simple addition. The findings also revealed that a close association between proficiency and achievement in math was evident. The implication is that educators need to be concerned about addressing this issue.

We believe it is very important to achieve proficiency with simple addition. Poor proficiency will act as a barrier to developing key conceptual knowledge as emergent understandings of number are not reinforced by efficient procedures and attentional resources are not made available during performance to discern underlying number concepts. The argument is based on the view that mathematical development is influenced by an iterative relationship between procedural and conceptual knowledge, where an increase in one type of knowledge leads to an increase in the other type of knowledge, in turn promoting deeper insight into the first type of knowledge (Canobi, 2009; Schneider & Stern, 2010). The finding of a close association between proficiency and achievement in math supports this view.

The findings are consistent with results from the learning disabilities (LD) field. Research in this field has established that students with a mathematics learning disability (MLD) (often identified by poor achievement) stay reliant on counting to perform simple addition at an age well beyond their typically achieving peers (Geary, 2010; Ostad & Sorenson, 2007, Torbeyns, Verschaffel, & Ghesquière, 2004). Students with a MLD are also more likely to exhibit counting and/or retrieval errors (Geary, et al., 2000) – particularly if they have a combined reading disability (Jordan, Hanich, & Kaplan, 2003). While the findings are consistent, they advance those reported in the literature in three important ways.

The findings of the present study suggest that difficulties achieving proficiency are more common than what is suggested in LD research. Research in this field has largely relied on a comparative approach where the simple addition performance displayed by a group of students with a MLD is compared to performance displayed by typically achieving students. Students are often identified as having a MLD based on achievement scores that fall below the 30th percentile (Murphy, Mazzocco, Hanich & Early, 2007). Thus by definition, the prevalence of a MLD is at most 30% of the population. It could be assumed that this figure also represents the prevalence of difficulties achieving proficiency. The prevalence of difficulties achieving proficiency appears to be more widespread than this.

The findings from the present study distinguished between the use of accurate counting and inaccurate counting. To our knowledge this distinction has only been made in one other study. Siegler (1988) found that six-year-old children who predominately used counting strategies accurately showed comparable math achievement to their peers who relied on retrieval but children who predominately used counting strategies inaccurately did not. Siegler referred to the first group of children as perfectionists and explained their preference for counting as being influenced by a high confidence threshold for retrieval. The present study is the first to examine the effects of adopting a perfectionist-like approach beyond the age of six. Accurate min counting among 12-year-old students *was* associated with lower math achievement. This has important implications for classroom practice. Approaches are needed to address difficulties achieving proficiency for students who display accurate min counting and will need to



focus on building confidence with retrieval. These will be different to approaches that address inaccuracy.

A third unique finding of the present study was that girls were more likely to exhibit accurate min counting than boys and boys were more likely to display proficiency. This finding is novel and needs to be corroborated by other research but is important to investigate further. It is generally acknowledged that more males than females are identified as experiencing learning difficulties even though differences in overall math achievement are not strongly evident (e.g., Vogel, 1990). It may be that assessments that contribute to the identification of learning difficulties focus more on accuracy than efficiency and this will need to be rectified in future research.

## References

- Ashcraft, M. H. (1995). Cognitive psychology and simple arithmetic: A review and summary of new directions. *Mathematical Cognition*, 1(1), 3-34.
- Australian Curriculum, Assessment and Reporting Authority. (2010). *Australian curriculum V1.2 - Mathematics: Content structure*. Retrieved from <http://www.australiancurriculum.edu.au/Mathematics/Content-structure>
- Baroody, A. J. (2006). Why children have difficulty mastering the basic number combinations and how to help them. *Teaching Children Mathematics*, 13, 22-31.
- Baroody, A., J., & Tiilikainen, S. P. (2003). Two perspectives on addition development. In A. Baroody & A. Dowker (Eds.), *The development of arithmetic concepts and skills: Constructing adaptive expertise* (pp. 75-125). Mahwah, NJ: Lawrence Erlbaum Associates.
- Canobi, K. H., (2009). Concept-procedure interactions in children's addition and subtraction. *Journal of Experimental Child Psychology*, 102, 131-149.
- Carpenter, T. P., & Moser, J. M. (1984). The acquisition of addition and subtraction concepts in grades one through to three. *Journal for Research in Mathematics Education*, 15, 179-202.
- Cowan, R., Donlan, C., Shepherd, D., Cole-Fletcher, R., Saxton, M., & Hurry, J. (2011). Basic calculation proficiency and mathematics achievement in elementary school children. *Journal of Educational Psychology*, 103(4), 786-803.
- Department for Education (2013). *The UK national curriculum framework*. Retrieved from <http://www.education.gov.uk/>
- Fuchs, L. S., Powell, S. R., Seethaler, P. M., Cirino, P. T., Fletcher, J. M., Fuchs, D., & Hamlett, C. L. (2010). The effects of strategic counting instruction, with and without deliberate practice, on number combination skill among students with mathematics difficulties. *Learning and Individual Differences*, 20(2), 89-100.
- Geary, D. C., Hamson, C. O., & Hoard, M. K. (2000). Numerical and arithmetical cognition: A longitudinal study of process and concept deficits in learning disabled children. *Journal of Experimental Child Psychology*, 77(3), 236-263.

- Hopkins, S. L., & Lawson, M. J. (2002). Explaining the acquisition of a complex skill: Methodological and theoretical considerations uncovered in the study of simple addition and the moving-on process. *Educational Psychology Review*, *14*, 121-154.
- Jordan, N. C., Hanich, L. B., & Kaplan, D. (2003). A longitudinal study of mathematical competencies in children with specific mathematics difficulties versus children with comorbid mathematics and reading difficulties. *Child Development*, *74*(3), 834-850.
- Murphy, M. M., Mazzocco, M. M. M., Hanich, L. B., & Early, M. C. (2007). Cognitive characteristics of children with mathematics learning disability (MLD) vary as a function of the cutoff criterion used to define MLD. *Journal of Learning Disabilities*, *40*(5), 458-478.
- National Council of Teachers of Mathematics. (2000). *Principles and standards for school mathematics*. Reston, VA: NCTM.
- Ostad, S. A., & Sorensen, P. M. (2007). Private speech and strategy-use patterns: Bidirectional comparisons of children with and without mathematical difficulties in a developmental perspective. *Journal of Learning Disabilities*, *40*(1), 2-14.
- Schneider, M., & Stern, E. (2010). The developmental relations between conceptual and procedural knowledge: A multimethod approach. *Developmental Psychology*, *46*(1), 178-192.
- Shrager J., & Siegler, R. S. (1998). SCADS: A model of children's strategy choices and strategy discoveries. *Psychological Science*, *9*(5), 405-410.
- Siegler, R. S. (1988). Individual differences in strategy choices: Good students, no-so-good students and perfectionists. *Child Development*, *59*(4), 833-851.
- Torbeyns, J., Verschaffel, L., & Ghesquière, P. (2004). Strategy development in children with mathematical disabilities: Insights from the choice/no-choice method and the chronological-age/ability/level-match design. *Journal of Learning Disabilities*, *37*, 119-131.
- Vogel, S. (1990). Gender differences in intelligence, language, visual-motor abilities, and academic achievement in students with learning disabilities: A review of the literature. *Journal of Learning Disabilities*, *23*(1), 44-52.

# WHAT ASPECTS OF MATHEMATICAL LITERACY SHOULD TEACHERS FOCUS ON FROM THE STUDENT'S POINT OF VIEW?

Feng-Jui Hsieh<sup>1</sup>, Ting-Ying Wang<sup>2</sup>

<sup>1</sup>National Taiwan Normal University, <sup>2</sup>RIHSS, National Science Council

*This study employed latent class cluster analysis to explore students' perceptions of what aspects of mathematical literacy, composed of mathematics competencies and attitudes, teachers should focus on. The sample included 1,219 Taiwanese senior high school students and 59 mathematics teachers. Three profiles were identified for mathematics competence, which were characterized as comprehensive, test-oriented, and limited thought-oriented. Regarding mathematics attitudes and mathematics learning attitudes, three profiles were identified and characterized as: broad, math-interior oriented, and mind-focused. Students and teachers differed in their perceptions on the importance of some aspects of mathematical literacy.*

## INTRODUCTION

Developing students' mathematical literacy has been a critical issue in both the academic study and practice of mathematics education. As early as 1986, the National Council of Teachers of Mathematics established the Commission on Standards for School Mathematics; the central tenet of these standards was the cultivation of mathematical literacy among students (Romberg, 2001). The Program for International Student Assessment, an international comparison study with more than 70 participating countries, also set mathematical literacy as a main focus of its survey.

Many researchers have focused on the structures and connotations of mathematical literacy. Kilpatrick (2001) identified "five strands of mathematical proficiency"—conceptual understanding, procedural fluency, strategic competence, adaptive reasoning, and productive disposition. The first four pertain to mathematics competence, and the last is related to mathematics attitudes and mathematics learning attitude. These two categories of literacy also correspond to the goals of the Taiwan national mathematics curriculum (Ministry of Education, 2010).

In Taiwan, the 12-year compulsory education program is nearly launched. In the program, mathematics classes will have a big difference from present which will be composed of students at various levels of mathematics, who have various perceptions about mathematics. Thus, probing into senior high school students' perceptions regarding what aspects of, and/or how, mathematical literacy teachers should focus on, is beneficial. Because mathematical literacy is constituted of numerous factors, major profiles were identified to allow teachers to easily understand the results of this study. The main research questions were:

1. What are the profiles that portray senior high school students' perceptions of which mathematics competencies teachers should focus on?
2. What are the profiles that portray senior high school students' perceptions of which mathematics and mathematics learning attitudes teachers should focus on?
3. What are the commonalities and differences between students' and teachers' perceptions of what aspects of mathematical literacy teachers should focus on?

## **RESEARCH METHOD**

### **Conceptual framework**

The conceptual framework for mathematical literacy in this study included a cognitive component, mathematics competences, and an affective component, attitudes toward mathematics and learning mathematics. The choice of items in the components was based on both a literature review and the results of a qualitative pilot study (see the section of instrument).

### **Mathematics competence**

The two major types of mathematics competence (MC) are content-oriented and thought-oriented mathematical competence (Hsieh, Lin, & Wang, 2012). Content-oriented mathematical competence is related to specific mathematics topics, for example, the possession of factual knowledge (Niss, 2003). Thought-oriented mathematical competence arises from the characteristics of mathematical thought rather than relates to specific knowledge of particular mathematical topics (Krutetskii, 1976), for example, exploring in mathematics problems, applying mathematics to solve problems arising in daily life (CCSSO & the NGA Center, 2010), manipulating statements and expressions containing symbols, and understanding others' written texts about mathematics in a variety of linguistic registers (Niss, 2003). This study emphasized thought-oriented, rather than content-oriented, mathematical competence.

### **Mathematics and mathematics learning attitude**

Many studies have discussed the structure of mathematics attitudes (MAs), and have developed measures to investigate students' mathematics attitudes (Lim & Chapman, 2013; Perry, 2011). In these studies, the value of mathematics and the usefulness of mathematics are considered critical. These studies have investigated students' perceptions regarding the usefulness of mathematics in daily life and other subjects, the power of mathematics to develop people's thinking, and etc.

Researchers have specified many positive mathematics learning attitudes (MLAs). Kim and Kim (2010) considered the intention to grasp the core mathematical concepts indicative of a positive learning attitude. In another study, being willing and perseverant to do mathematics was considered indicative of a positive learning attitude (Yang & Tsai, 2010). Studies have also regarded the employment of appropriate learning methods to be indicative of a positive learning attitude (Kim & Kim, 2010; Yang & Tsai, 2010).

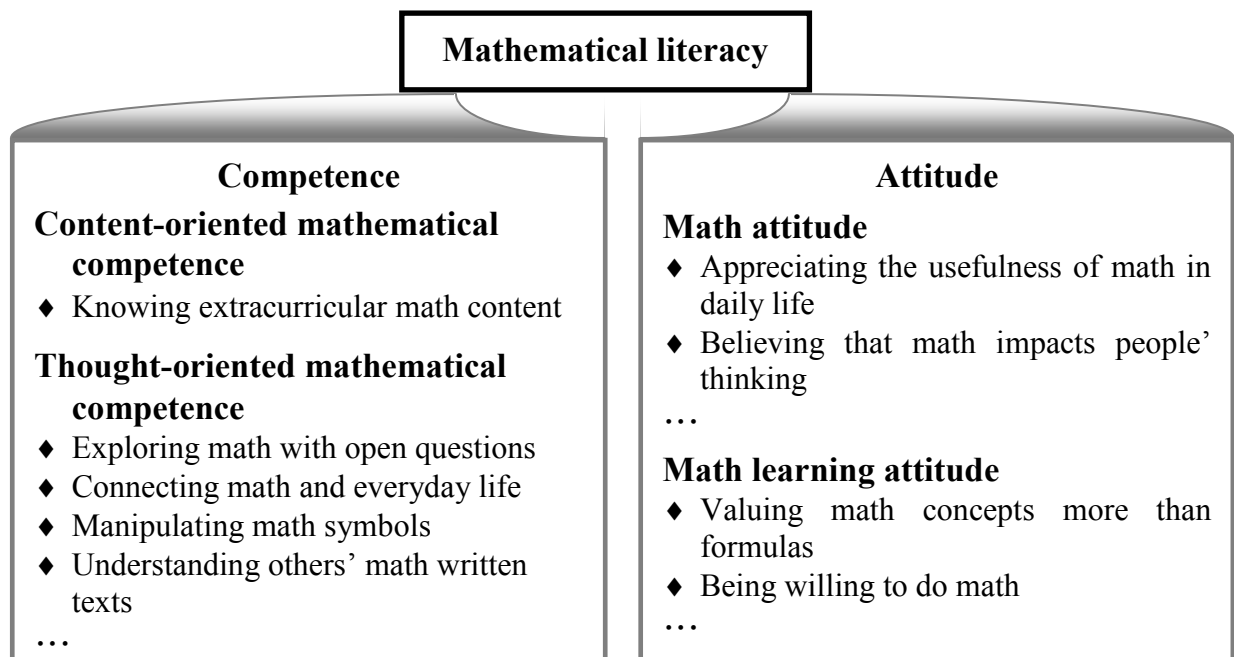

Figure 1: The framework of this study

### Design and Instrument

This study was conducted in two stages. In the first stage, a qualitative pilot study using open-ended questions was conducted, to obtain 238 high school students' opinions regarding what an ideal mathematics teacher would do when conducting a variety of teaching tasks, such as introducing new mathematical concepts. A content analysis of the students' responses was performed to obtain dimensions and items related to mathematical literacy by experts including university mathematics educators and researchers, school-based supervisors of future mathematics teachers, and expert secondary school mathematics teachers. A literature review was conducted to obtain further dimensions and items, which were included in the second stage. In the second stage, a questionnaire with dichotomous items was administered; on the questionnaire, students were asked to state whether or not a good senior high school mathematics teacher would focus on a certain literacy item in a particular teaching context; an example is shown in Figure 2. This study used two questions in the questionnaire, one question measured MC and the other measured MA and MLA; both questions consisted of 11 items. Complete lists of these questions are shown in Figures 3 and 4.

<p>To develop our mathematics competence, a very good senior high school mathematics teacher would...</p> <p><input type="checkbox"/> 1. Cultivate our abilities of expressing mathematics by asking us to explain our own methods to other classmates.</p> <p>...</p> <p><input type="checkbox"/> 4. Teach us how to employ sequencing steps of reasoning according to the information provided by a mathematics problem</p>
---

Figure 2: The question related to mathematics competence

## Participants

In the first stage, 238 high school students in 6 classes were surveyed. In the second stage, 1,219 senior high school students from 61 classes and their mathematics teachers (59 in total) were surveyed. These students attended 30 schools in 23 cities out of Taiwan's 25 cities. The sampled schools were randomly selected. In each school, two or three classes were chosen randomly. Students in the 10th, 11th, and 12th grades constituted 24%, 41%, and 35% of the sample, respectively.

## Data analysis

This study employed latent class cluster analysis (LCA), a model-based approach (Muthén, 2001), to analyze the MC and MA&MLA data separately. LCA enabled the interrelationships between observed variables, the responses regarding whether or not an ideal teacher would focus on a literacy item, to be analyzed. Subsequently, latent classes were identified for students' perceptions regarding what aspects of mathematical literacy teachers should focus on. For each literacy item, the conditional probability that a student in a particular class would agree with that item was obtained. The distributions of these conditional probabilities for all literacy items in a certain class were obtained to depict its profiles of students' perceptions of which aspects of mathematical literacy teachers should focus on (hereafter, this conditional probability is referred to as "focusing probability"). For each student, the probabilities of being assigned into each latent class were obtained, which were summed to 1. These probabilities were averaged over the individuals in the same class to obtain the relative size of the class.

Log likelihood (LL) and adjusted Bayesian information criterion (BIC) statistics were employed as goodness-of-fit criteria; smaller values indicated a better fitting model. Entropy was used to measure how well the model classified students. It should be above 0.6 for medium level and above 0.8 for high level (Clark & Muthén, 2009). Relative criteria were also considered. Differences in BIC and LL statistics, and Vuong-Lo-Mendall-Rubin (VLMR) tests, were used to assess the improvement of model parsimony by comparing the model with  $n$  classes to a model with  $n-1$  classes.

Percentages of teachers' checking for each item were calculated to determine teachers' perceptions of which aspects of mathematical literacy a teacher should focus on.

## RESEARCH FINDINGS

### Mathematics competence

Models with more classes were preferred, according to the LL and BIC criteria. However, differences in BIC and LL gradually diminished as the number of classes increased, indicating that improvements in model parsimony shrank. The VLMR tests suggested that the 4-class model did not fit the data better than the 3-class model ( $p = .30$ ), and the 3-class model offered a significantly more adequate fit than the 2-class model ( $p = .01$ ). After further consideration of entropies, the 3-class model was selected because of it offered the optimal and most parsimonious representation.

No. of classes	Entropy	Log likelihood	Adjusted BIC	Diff(LL)	VLMR <i>p</i> -value	Diff(BIC)
1	-	-4636.577	9316.286	-	-	-
2	0.675	-4234.465	8559.117	-402.112	.00	-757.169
3	0.708	-4194.814	8526.868	-39.651	.01	-32.249
4	0.638	-4170.410	8525.114	-24.404	.30	-1.754
5	0.687	-4157.429	8546.205	-12.981	.60	21.091

Table 1: Fit statistics for latent class analysis of MC

As shown in Figure 3, the focusing probabilities of Class 1 were higher than 90% for all MC items except “exploring math with open questions,” which still had a probability of 85%. Students classified in Class 1, which had a relative size of 57%, indicated that teachers should focus on every MC item listed in Figure 3. The profile this class portrayed was thus characterized as “comprehensive.” By contrast, students classified in Class 2 (38%) indicated that teachers should focus more on the first six MC items than on the last five MC items, as shown in Figure 3 (the first and second categories, respectively).<sup>1</sup> The MCs in the second category were considered less crucial to success on senior high school mathematics tests in Taiwan. The profile of Class 2 was thus characterized as “test-oriented.” Compared with students in Classes 1 and 2, the students in Class 3 (5%) indicated that teachers should focus on limited mathematical competencies, and only four competencies had focusing probabilities higher than 50% for this group, three of which were related to mathematics thought in questions, and one of which was related to mathematics language (Niss, 2003). This study thus characterized the profile as “limited thought-focused.” In terms of teachers’ perceptions, teachers indicated that all MC items should be focused on in the classroom, with only two exceptions—“knowing extracurricular math content” and “exploring math with open questions.”

Cultivating students’ abilities to explore mathematics has been a critical issue in mathematics education worldwide (e.g., Hsieh, Horng, & Shy, 2012). In Taiwan, a project presently underway, the “Highlight-base program,” which aims at promoting mathematics teachers’ professional development, chooses developing teachers’ abilities to integrate mathematics exploration into the classroom as one focus. However, “exploring math with open questions” was the MC item with the lowest focusing probability (students’) and the lowest checking percentage (teachers’). Further research is necessary to determine whether this indicates that students and teachers do not perceive exploring as a crucial aspect of MC or that they do not think exploring on open questions are helpful to cultivate students on this MC? Moreover, teachers indicated that teachers should focus on “orally expressing one’s own math problem-solving method.” Oral expression of the problem-solving process allows

<sup>1</sup> Factor analysis was conducted to divide the competences into two categories.

students to reconstruct their mathematical thinking, enabling them to come to a clearer understanding. However, some students did not necessarily share their teachers' perceptions in this regard.

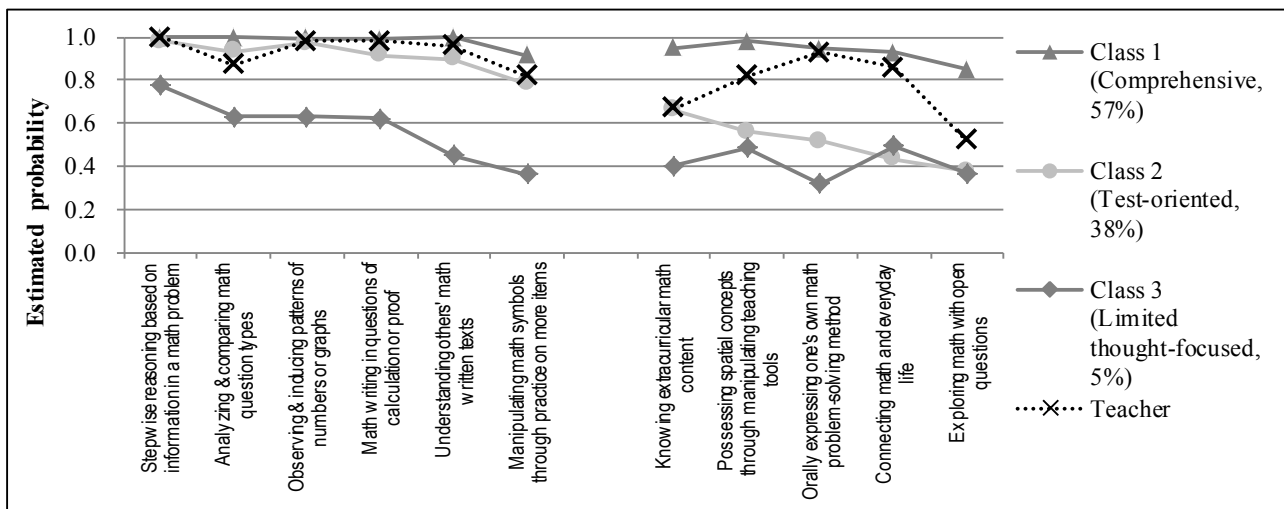

Figure 3: Three profiles of students' perception on the importance of MC

**Mathematics and mathematics learning attitude (MA&MLA)**

Based on the fit statistics shown in Table 2, the 3-class model was selected because it offered the optimal, most parsimonious representation.

No. of classes	Entropy	Log likelihood	Adjusted BIC	Diff(LL)	VLMR p-value	Diff(BIC)
1	-	-4222.155	8487.505	-	-	-
2	0.760	-3695.289	7480.896	-526.866	.00	-1006.609
3	0.782	-3626.110	7389.662	-69.179	.00	-91.234
4	0.770	-3595.817	7376.199	-30.293	.54	-13.463
5	0.801	-3569.918	7371.523	-25.899	.06	-4.676

Table 2: Fit statistics for latent class analysis of MA&MLA

The profiles of the three classes are shown in Figure 4. The first five items in the figure belong to mathematics attitude (MA), and the last six items belong to mathematics learning attitude (MLA). Regarding Class 1, focusing probabilities were higher than 90% for all attitudes except “appreciating contributions of math to human civilization through stories.” Nonetheless, even this attitude reached a probability of 83%. Class 1 was therefore characterized as “broad.” Students in Class 2 also considered MLA items to be critical, but “believing that math impacts people’s thinking” was the only MA item with a focusing probability over 50%. Students in Class 2 did not think that teachers should focus on application outside mathematics (e.g., to other subjects or daily life). The profile portrayed by Class 2 was thus characterized as “math-interior oriented.” The profile of Class 3 is similar to that of Class 2 in terms of the MA part –



only highly considering that math impacts people's thinking as the MA teachers should focus on. However, students in Class 3 valued MLA items that were pertinent to ideas, thoughts, and volition in mind but not items related to actual actions: "being willing to do mathematics" and "being willing to ask math questions." Therefore, this study characterizes Class 3 as "mind-focused." The teachers' perception is shown in Figure 4, which indicates that teachers believed that every MA and MLA item should be focused on by teachers.

In contrast to their teachers, 33% of students (Classes 2 and 3) did not consider that teachers should focus on applying mathematics to other fields (the 2<sup>nd</sup> to the 5<sup>th</sup> items), and 17% of students did not consider the MLAs related to taking actual actions to work on mathematics should be focused on. Whether student consider these attitudes as not important or may not be teachers' responsibilities to foster is worthy of future investigation.

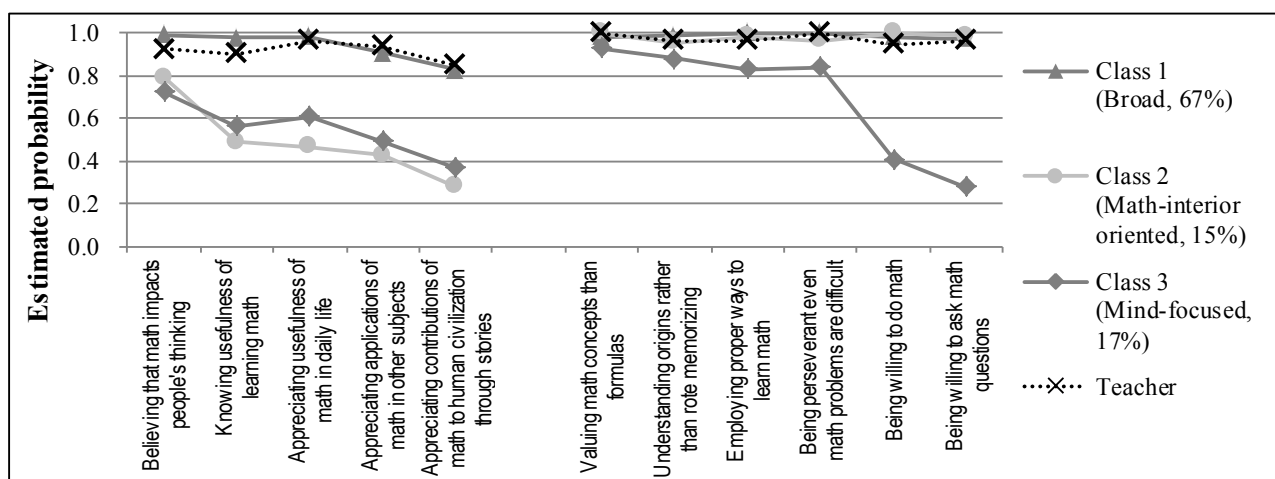

Figure 4: Three profiles of students' perception on the importance of MA&MLA

## CONCLUSION

Using LCA, different profiles of Taiwanese senior high school students' perceptions of which aspects of mathematical literacy teachers should focus on were identified. Regarding mathematics competence, the three profiles were characterized as comprehensive, test-oriented, and limited thought-oriented. In terms of mathematics and mathematics learning attitudes, the three profiles were characterized as broad, math-interior oriented, and mind-focused. Certain students deviated from their teachers' perceptions regarding competencies and attitudes they believed teachers should focus on. Further investigation is required to find out the reason behind, for example, whether students believe the mathematical literacy is unimportant, whether teaching methods are effective at developing the literacy, and whether cultivating the literacy is a teacher's responsibility. The results of this study provide a valuable reference for teachers, to allow them to determine what to emphasize in cultivating mathematical literacy among students.

## References

- CCSSO & the NGA Center. (2010). *Common core state standards for mathematics*. Washington, DC: Author.
- Clark, S., & Muthén, B. (2009). *Relating latent class analysis results to variables not included in the analysis*. Retrieved from <http://www.statmodel.com/download/relatinglca.pdf>
- Hsieh, F.-J., Horng, W.-S., & Shy, H.-Y. (2012). From exploration to proof production. In G. Hanna & M. de Villiers (Eds.), *Proof and proving in mathematics education* (pp. 279-304). NY: Springer.
- Hsieh, F.-J., Lin, P.-J., & Wang, T.-Y. (2012). Mathematics related teaching competence of Taiwanese primary future teachers: Evidence from the TEDS-M. *ZDM*, 44(3), 277-292.
- Kilpatrick, J. (2001). Understanding mathematics literacy: the contribution of research. *Educational Studies in Mathematics*, 47, 101-116.
- Kim, S. H., & Kim, A. S. (2010). The effects of mathematical modeling on creative production ability and self-directed learning attitude. *Asia Pacific Education Review*, 11, 109-120.
- Krutetskii, V. A. (1976). *The psychology of mathematical abilities in schoolchildren*. (J. Teller, Trans.). Chicago: The University of Chicago Press. (Original work published 1968)
- Lim, S. Y., & Chapman, E. (2013). Development of a short form of the attitudes toward mathematics inventory. *Educational Studies in Mathematics*, 82(1), 145-164.
- Ministry of Education (2010). 國民中小學九年一貫課程綱要數學學習領域 [Grade 1-9 Curriculum Guidelines]. Retrieved from [http://www.google.com.tw/url?sa=t&rct=j&q=&esrc=s&source=web&cd=1&ved=0CC0QFjAA&url=http%3A%2F%2Fteach.eje.edu.tw%2Fdata%2Ffiles%2Fclass\\_rules%2Fmath.pdf&ei=akHKUt6lNsuQiQeNnIC4DQ&usg=AFQjCNF5Y7dVztMk25Q5HxAmYN5v sUCvJA&sig2=VUTXIIA8Q-Hucgb5eGy0KA](http://www.google.com.tw/url?sa=t&rct=j&q=&esrc=s&source=web&cd=1&ved=0CC0QFjAA&url=http%3A%2F%2Fteach.eje.edu.tw%2Fdata%2Ffiles%2Fclass_rules%2Fmath.pdf&ei=akHKUt6lNsuQiQeNnIC4DQ&usg=AFQjCNF5Y7dVztMk25Q5HxAmYN5v sUCvJA&sig2=VUTXIIA8Q-Hucgb5eGy0KA)
- Muthén, B. (2001). Latent variable mixture modeling. In G. A. Marcoulides & R. E. Schumacker (Eds.), *New developments and techniques in structural equation modeling* (pp. 1-33). Mahwah, NJ: Lawrence Erlbaum Associates.
- Niss, M. A. (2003). Mathematical competencies and the learning of mathematics: the Danish KOM project. In A. Gagatsis & S. Papastavridis (Eds.), *3<sup>rd</sup> Mediterranean Conference on Mathematical Education* (pp. 116–124). Athens: Hellenic Mathematical Society.
- Perry, C. A. (2011). Motivation and attitude of preservice elementary teachers toward mathematics. *School Science and Mathematics*, 111(1), 2-10.
- Romberg, T. A. (2001). Mathematical literacy: what does it mean for school mathematics? *Wisconsin School News*, 56(6), 5-31.
- Yang, D. C., & Tsai, Y. F. (2010). Promoting sixth graders' number sense and learning attitudes via technology-based environment. *Educational Technology & Society*, 13(4), 112-125.

# INVESTIGATING CHILDREN'S ABILITY TO SOLVE MEASUREMENT ESTIMATION PROBLEMS

Hsin-Mei E. Huang

University of Taipei

*In this study, how fourth- to sixth-grade children perform measurement estimation was investigated. The data were collected by a measurement estimation task that contained linear and area estimations and interviews from 72 children, each in one fourth- ( $n = 21$ ), fifth- ( $n = 32$ ), or sixth-grade ( $n = 19$ ) class at local public elementary schools in cities in north Taiwan. The results indicated significant differences in the performance of the children in the estimation task among the three grade levels. The sixth-graders were observed to outperform the fourth-graders but they performed similarly to the fifth-graders. Grade level also influenced children's ability to estimate area rather than linear estimation. The children's strategies used for estimating an object with a long length included Benchmark, Guessing, Looking, and Other strategies.*

## INTRODUCTION

Measurement estimation, like problem solving, requires knowledge of measurement and the ability to use effective strategies to make reasonable estimates (Joram, Subrahmanyam, & Gelman, 1998). Children learn to perform measurement estimation by using visual perception at an early age (Sarama & Clements, 2009). However, elementary school children have been observed to be unsuccessful in making reasonable estimates (Chan, 2001; Forrester, Latham, & Shire, 1990).

In recent years, mathematics curricula and instruction in Taiwan (Taiwan Ministry of Education [TME], 2010) and other countries (e.g., National Council of Teachers of Mathematics [NCTM], 2000, 2006) have focused on measurement estimation. Although the importance of measurement estimation in mathematics education has attracted the attention of mathematics educators and researchers (Sarama & Clements, 2009), research on children's ability to perform measurement estimation remains inadequate.

Children's ability to perform measurement estimation is influenced by several factors such as the type of measure being estimated (e.g., linear or area), grade level (or age) (Forrester et al., 1990; Joram et al., 1998; Siegel, Goldsmith, & Madson, 1982), and problem contexts that require estimations (type of unit and quantity; Forrester et al., 1990). Generally, estimating length (or distance) is easier than estimating area (Chan, 2001). Children in higher grades were observed to be more successful in measurement estimation than those in lower grades (Siegel et al., 1982). However, some studies (Swan & Jones, 1980; Montague & Van Garderen, 2003) indicated that an increase in estimation ability was not necessarily positively associated with an increase in grade level.

In addition to the aforementioned factors, Montague and Van Garderen (2003) suggested that curriculum and pedagogy may affect the ability of students to estimate in early grades. To strengthen students' mathematical power effectively, instructors must have a clear understanding of children's mathematical knowledge and skills. Thus, studies on the ability of children to estimate in varying grade levels are needed.

The present study extends previous studies on mathematical problem solving by exploring the estimation ability and strategies used by fourth- to sixth-grade children who received mathematics instruction that emphasized measurement estimations. This study focused on the ability of children to solve problems involving the estimation of linear and area measurements and addressed the following two research questions:

1. What are differences in the ability of children to perform linear estimations and area estimations among grade levels?
2. What are the strategies that children have adopted for estimating an object with a long length?

## **THEORETICAL FRAMEWORK**

### **Mathematical Thinking Involved in Measurement Estimation**

“Estimating” is the process in which a reasonable quantity or size of an object is provided without using measurement tools or measuring the object. The ability to perform measurement estimation involves multiple components, including estimating, approximating, and measuring, which lay the foundation for understanding physical measurement (Joram et al., 1998).

Furthermore, Carter (1986) and Joram, Subrahmanyam, and Gelman (1998) have purposed that developing a mental frame of reference for the sizes of units of measure requires constructing a mental structure that involves multiple cognitive processes of decomposing and re-compositing an object (or a numerical computation) to be estimated as well as comparing benchmark mental representations (e.g., physical references). Such measurement thinking is constructed based on sufficient knowledge of physical measurement and experiences in real measurement.

### **The Relationships Among the Types of Attributes To Be Estimated, Grade Level, and Ability To Perform Measurement Estimations**

Joram et al. (1998) suggested that the basic unit-covering principle applies to both length and area measurement. Estimating linear measurement involves applying the unit-covering principle and mentally repeating units to estimate an object in one-dimension, such as length and distance. Children are able to compare length visually, which is the basis of length estimation, at a young age (Sarama & Clements, 2009). Moreover, knowledge of linear measurement and strategies for estimating lengths (e.g., guessing-and-checking) are frequently provided in the measurement curricula followed in early school years (NCTM, 2000, 2006; TME, 2010).

Area measurement, which involves two-dimensional spatial knowledge, requires knowledge of length measurement. Although not all estimation skills are developed similarly, regarding estimating area, applying the unit-covering principle and mentally repeating square units to estimate an object in two-dimensions is effective (Joram et al., 1998). For example, an area can be estimated by comparing the area to be estimated directly to one of the standard units of area. However, because the complexity of measuring length and area is different, studies have determined that children perform more successfully in linear estimation than in area estimation (Chan, 2001).

Forrester, Latham, and Shire (1990) determined that greater familiarity with measurement procedures and strategies related to numerical calculations improves children's competence in measurement estimation. Moreover, Joram et al. (1998) argued that students develop estimation ability and improve the strategies they use for estimation as they gain knowledge of physical measurement in higher grade levels, because knowledge and experience in real measurement is an indispensable requirement for measurement estimation.

Conversely, other studies (Swan & Jones, 1980; Montague & Van Garderen, 2003) have determined that students' performance in measurement estimation is not necessarily positively associated with a high grade level. For example, Swan and Jones (1980) observed that junior high-school students performed more favourably than high-school students in estimating long distances and metrically estimating the heights.

Moreover, Montague and Van Garderen (2003) compared the estimating ability of students who exhibited different mathematics abilities and levels of grade placement (Grades 4, 6, and 8). The results indicated that the fourth-grade children who received instruction based on a mathematics curriculum that reflected NCTM standards (NCTM, 2000) and that focused on measurement estimation outperformed the children in higher grades who used a different mathematics curriculum. The results of the study suggested that mathematics curricula and instruction may influence the estimation ability of children.

### **Children's Strategies for Performing Measurement Estimations**

Forrester et al.'s (1990) and Chan's (2001) studies have determined that children frequently provide estimates by observing (visualizing) or guessing. Although visualization serves as the foundation for estimating, visualization is unlikely to generate a reasonable estimate without being facilitated by knowledge of measurement units and reference quantities. Furthermore, guessing may provide a gross estimate, but using this strategy without carefully recognizing the levels of reasonableness may yield poor estimates, such as substantial underestimates or overestimates.

Another approach, involving the use of benchmarks in which nonstandard units or events are used as referents for estimating may yield more accurate estimates than guessing does (Carter, 1986). Moreover, benchmarks that are constructed based on objects that are familiar to estimators can be more meaningful than standard units.

When children use standard units or benchmarks for estimating, they first decompose the objects to be estimated into samples for which basic estimate skills can be used (e.g., comparing and decomposing) and then recompose the objects to determine the estimated quantities (e.g., computing) (Carter, 1986; Forrester et al., 1990).

## **METHODOLOGY**

### **Participants**

The sample consisted of 72 children (40 boys and 32 girls), each in one fourth- ( $n = 21$ ), fifth- ( $n = 32$ ), or sixth-grade ( $n = 19$ ) class at local public elementary schools in cities in north Taiwan. The mean ages of the children in each grade were 10.19 years for Grade 4 ( $M = 122.24$ ,  $SD = 3.63$ ), 11.26 years for Grade 5 ( $M = 135.13$ ,  $SD = 4.85$ ) and 12.22 years for Grade 6 ( $M = 146.58$ ,  $SD = 3.61$ ). All of the participants had received instruction on length and area measurements, which was given based on the mathematics textbooks that reflected the guidelines for mathematics curriculum (TME, 2010) and that focused on measurement estimation, before participating in the study.

### **Instrument**

In this study, an estimation task consisting of 12 problems that required estimating measures of length and area was designed by referring to textbook materials and the estimation tasks of Chan (2001). For example, “Estimate (without using a ruler) the length of the rope. (①4.2~5.0 m; ②6.1~7.0 m; ③5.0~6.0 m)” and “Estimate (without using a ruler) the length of the body of the caterpillar? ( ) cm.” The objects of which the length or area was to-be-estimated in the problems were visually presented to the participants by using real objects or figures of the objects. The problems were divided into two subsets of six problems (i.e., subscales of linear estimation and area estimation). The estimation task was completed in 40 minutes.

The strategies that the children used for estimating linear measurement were collected from the participants’ written answers to and interviews on an estimation problem that required estimating the length of a long object (5.6 meters). The interview, during which the participants were asked “What methods do you use for estimate the long rope?” was conducted after the participants completed the estimation task.

### **Scoring and category of estimation strategy**

Numerical estimates were scored for accuracy and acceptableness (Siegel et al., 1982). “Accuracy” was defined as an estimate that was between plus 10% and minus 10% of the actual value. “Acceptableness” was defined as an estimate that was between plus 25% and minus 25% of the actual value. An “accurate” estimate was scored 2-points, whereas an “acceptable estimate” was scored 1-point. If an estimate was greater than plus 25% of the actual value or lower than minus 25% of the actual value, a score of “0” was allocated. The total score of each subscale was 12 points.

In this study, four types of estimation strategies that children tend to use for performing measurement estimation by referring to Forrester et al. (1990) and Chan (2001) were

used to classify the participants' strategies. The four types of strategies included: (a) Looking: "Looking" involves estimating the sizes of objects by using the naked eye (perception) without computation and using standard (or nonstandard) units to decompose and recombine the objects to be measured. (b) Guessing: A guessing estimate represents a gross estimate (Carter, 1986). An estimate that is generated by guessing without thinking properly about the correct answer needs to be recognized (and refined). Thus, a guessing estimate involves a conjecture. (c) Benchmark: Children select objects that are readily available in a classroom or body parts as references for estimation. (d) Other: This category contained a response of "Do not know" or implicitly describing a strategy or no answers.

The written answers for the estimation task of 26 children were independently scored by two raters. Regarding the reliability of the estimation problems scores, Pearson correlations indicated that the inter-rater agreement was  $r = .98, p < .01$ . Moreover, Kappa analyses were administered to test the reliability of the coding of the children's estimation strategy. The coding of the children's estimation strategy was assessed at  $.98, p < .01$ .

## RESULTS

Table 1 presents the means and standard deviations of the performance of the children in the two subscales of measurement estimation and the entire estimation task according to grade level.

Types of measurement estimation	Grade 4			Grade 5			Grade 6			Total		
	<i>n</i>	<i>M</i>	<i>SD</i>	<i>n</i>	<i>M</i>	<i>SD</i>	<i>n</i>	<i>M</i>	<i>SD</i>	<i>n</i>	<i>M</i>	<i>SD</i>
Linear estimation	21	5.91	2.05	32	6.19	2.66	19	7.47	2.22	72	6.44	2.43
Area estimation	21	4.14	1.20	32	5.69	1.94	19	6.11	2.11	72	5.35	1.95
Entire estimation task	21	10.05	2.06	32	11.88	3.30	19	13.58	3.01			

Table 1: Means and Standard Deviations for the Children's Estimation Performance by Grade Level and Type of Measurement Estimation

To compare children's performance in the estimation task among grade levels, a one-way ANOVA was conducted. The results indicated significant differences in the performance of the children in the estimation task among the three grade levels,  $F(2, 69) = 7.36, p < .01, \eta^2 = .18$ . Schéffe post-hoc tests, used to analyze the differences in grade levels, indicated that the six-grade group significantly outperformed the fourth-grade group. The differences between the fifth-grade and fourth-grade groups were statistically nonsignificant. Furthermore, no differences were observed between the fifth-grade and six-grade groups.

Additionally, to compare performance yielded by the three grade levels in two types of measurement estimation were conducted by using 3 (grade level: Grade 4, 5, and 6) x 2 (estimation: linear and area estimations) within-subject analyses of variance (ANOVAs). Significant interaction effects were not found for the estimation

performance,  $F(2, 69) = 1.18$ ,  $p = .32$ . The main effect of type of measurement estimation reached statistical significance,  $F(1, 69) = 10.67$ ,  $p < .01$ ,  $\eta^2 = .13$ . Moreover, the main effect of grade level also reached statistical significance,  $F(2, 69) = 7.36$ ,  $p < .01$ ,  $\eta^2 = .18$ .

Regarding the subscale of linear estimation, the results indicated that no significant differences among grade levels,  $F(2, 69) = 2.50$ ,  $p = .09$ . Regarding the subscale of area estimation, the results indicated significant differences in the performance of the children among the three grade levels,  $F(2, 69) = 6.91$ ,  $p < .01$ ,  $\eta^2 = .17$ . Schéffe post-hoc tests, used to analyze the differences in grade levels, indicated that both the fifth- and sixth-grade groups significantly outperformed the fourth-grade group. However, no differences were observed between the fifth- and sixth-grade groups. This result was consistent with the results regarding the comparison of the entire estimation task.

The follow-up comparison on the differences between the scores of linear estimation and area estimation in each grade, the results indicated that the fourth-grade group obtained higher scores in the subscale of linear estimation than those in the subscale of area estimation,  $F(1, 69) = 6.94$ ,  $p < .01$ . Such differences in the scores between the two subscales were not exhibited in the fifth-grade group,  $F(1, 69) = .85$ ,  $p = .36$ , nor in the sixth-grade group,  $F(1, 69) = 3.79$ ,  $p = .06$ .

Regarding the analysis of the strategies used by the children, because the children reported using multiple types of strategy, each type of strategy reported was coded and the total frequency of each category was calculated. The strategies consisted of four types: “looking,” “guessing,” “benchmark,” and “other.” The frequencies at which each strategy was used are ranked from high to low as follows: “Benchmark” (50 times), “Guessing” (9 times), “Looking” (8 times), and “Other” (5 times). For the use of “Benchmark,” the children tended to use body parts (e.g., the length of fingers, the length between the index finger and thumb stretched, the feet, the palm of the hand, and the length of outstretched arms) and objects in the classroom (e.g., an eraser, a pencil, and the length of a tile on the ground of the classroom, and a blackboard). Regarding the “other” strategy, five children were categorized in the category, including two children who omitted to answer and three children who did not explicitly describe the approach they used (e.g., “measuring” or “drawing”).”

## **DISCUSSION AND IMPLICATIONS FOR MATHEMATICS EDUCATION**

This study examined children’s competence in measurement estimations. The results of this study are summarized and discussed below. First, grade levels were related to differences in the measurement estimation ability of the children. For the entire estimation task, the six-grade children were more successful in performing measurement estimation than the fourth-grade children. The results of this study partially supported those of Siegel, Goldsmith, and Madson (1982) that reported that the children in Grade 6 provided more accurate estimates than did the children in Grades 2 to 5. The partial results that were inconsistent with those of Siegel’s study



may result from the differences in curricula and instruction of school mathematics and the problem contexts (e.g., units and quantity) (Forrester et al., 1990).

Second, the factor of grade level also influenced the ability of children to estimate area. The children who were in fifth and sixth grades were more competent in estimating area than those in fourth-grade group. Moreover, both the fifth- and sixth-grade groups exhibited similar abilities for estimating area. The results suggested that, for the subscale of area estimation, the children in a higher grade level were more competent in area estimation than the children in fourth grade. However, the factor of grade level did not significantly influence the ability of children to estimate length. This finding is consistent with that of Forrester et al. (1990).

Overall, regarding the results on area and linear estimation, the fourth-grade children, who received instruction in linear and area measurement, could perform similarly to the fifth- and sixth-grade children in linear estimation but not in area estimation. The results may be caused by the differences in complexity between linear estimation and area estimation and the amount of experience in performing the two types of estimations. The process of area estimation is more complex than that of linear estimation (Chan, 2001; Sarama & Clements, 2009). Children require more knowledge of area measurement and experience in real measurement to make area estimation. Remarkably, the fifth-grade children performed equally well as the sixth-grade children did in the entire estimation task and the two subscales. However, the fifth-grade group did not outperform the fourth-grade group. This is probably because of the dissimilar approach of instruction on measurement that the participants received. Additionally, this implies that Grade 4 to 5 is a crucial stage at which the ability of children to perform measurement estimation, particularly, linear and area estimation, is developed. However, this assumption requires further investigations.

Finally, most of the children reported using one (or more) strategies for estimating an object with a long length; however, some children reported using of “looking” and “guessing” and “other” strategies. Compared with the results of Forrester et al. (1990) and Chan (2001) regarding the estimation strategies used by children, the results of this study indicated that the participants were inclined to use benchmarks for making estimation and were less likely to express “Do not know,” “Guessing,” or “thought.” These differences in strategy use may result from their experience in and knowledge of measurement that was obtained from school mathematics and everyday life.

Skill in measurement estimation (e.g., the use of strategies) can be improved through instruction (Joram et al., 1998). Grade level, which represents the amount of measurement experience acquired from school mathematics, may affect on the ability of children to measurement estimation. The more opportunities teachers provide for students to develop knowledge of measurement and experience in estimating, the more developed students’ abilities to measurement estimation may become.

## References

- Carter, H. L. (1986). Linking estimation to psychological variables in the early years. In H. L. Schoen & M. J. Zweng (Eds.), *Estimation and mental computation: 1986 yearbook* (pp. 74-81). Reston, VA: National Council of Teachers of Mathematics.
- Chan, C.-W. (2001). *A study of fifth-grade children's abilities in estimating measures and numerosity in Pingtung and Kaohsiung* (Unpublished master's thesis) [in Chinese]. Graduate Institute of Mathematics Education, National Pingtung Teachers College, Taiwan.
- Forrester, M. A., Latham, J., & Shire, B. (1990). Exploring estimation in young primary school children. *Educational Psychology, 10*, 283-300.
- Joram, E. (2003). Benchmarks as tools for developing measurement sense. In D. H. Clements (Ed.), *Learning and teaching measurement* (pp. 57-67). Reston, VA: National Council of Teachers of Mathematics.
- Joram, E., Subrahmanyam, K., & Gelman, R. (1998). Measurement estimation: Learning to map the route from number to quantity and back. *Review of Educational Research, 68*, 413-419.
- Montague, M., & Van Garderen, D. (2003). A cross-sectional study of mathematics achievement, estimation skills, and academic self-perception in students of varying ability. *Journal of Learning Disabilities, 36*(5), 437-488.
- National Council of Teachers of Mathematics. (2000). *Principles and standards for school mathematics*. Reston, VA: Author.
- National Council of Teachers of Mathematics. (2006). *Curriculum focal points for prekindergarten through grade 8 mathematics: A Quest for coherence*. Reston, VA: Author.
- Sarama, J., & Clements, D. H. (2009). *Early childhood mathematics education research: Learning trajectories for young children*. New York: Routledge.
- Siegel, A. W., Goldsmith, L. T., & Madson, C. R. (1982). Skill in estimation problems of extent and numerosity. *Journal for Research in Mathematics Education, 13*, 211-232.
- Swan, M., & Jones, O. (1980). Comparison of students' percepts of distances, weight, height, area, and temperature. *Science Education, 64*, 297-307.
- Taiwan Ministry of Education. (2010). *Grade 1-9 curriculum for junior high school and elementary school: mathematics* (3<sup>rd</sup> ed.). Taipei, Taiwan: Author.

# SMALL GROUP INTERACTIONS: OPPORTUNITIES FOR MATHEMATICAL LEARNING

Roberta Hunter, Glenda Anthony

Massey University

*Small group interactions can provide rich conceptual mathematical understandings. This paper reports on the mathematical talk of Māori and Pāsifika students as they participated in small group activity. The findings illustrate that when the students were scaffolded to work collaboratively the talk shifted between focusing on mathematics (mathematizing) and people (subjectifying) and this supported their learning.*

## INTRODUCTION

Student talk, and the role it holds in mathematics education, has increasingly been explored by mathematics education researchers in recent decades. The general consensus is that students learn richer and deeper mathematical concepts when provided with opportunities to engage in talk and interactions with others during mathematical activity (White, 2003; Wood, Williams, & McNeal, 2006). However, we know that just any student talk or interaction is not sufficient to ensure conceptual learning within productive talk. For example, Cohen (1994) and Mercer and Wegerif (1999) argue the importance of problem solving activity in which students are required to rely on each other and use exploratory talk. Other researchers (e.g., Boaler, 2008; Hunter, 2007) promote the need for teachers to develop productive mathematical talk through activity that requires group members to interact and work collaboratively. Although the importance of productive mathematical discourse is well recognised, what forms it can take are less well-known. Likewise, we do not know what other social forms of talk also support student learning. The focus of this paper is on the mathematical and social talk used within small group interactions. The specific research questions explored in this paper are:

What patterns of interaction did the students engage in during small group activity?

How did the patterns of interaction support or limit individual opportunities for mathematical learning?

The theoretical framework of this study is derived from a sociocultural perspective. From this perspective sociocultural researchers (e.g., Andriessen, 2006; Lerman, 2001) suggest that academic learning is inherently social and embedded in active participation in communicative reasoning processes. This includes attending to the academic and social aspects of the interactions and provides reasons for exploring all forms of talk used in small group activity to explain how the interactions may provide affordances or constraints in the learning process.

## CONCEPTUAL FRAMEWORK

Within the commognitive framework proposed by Sfard (2008) student talk is intertwined with mathematical learning. Sfard (2008) outlines how as students engage in activity their mathematical talk draws closer to more academic mathematical discourses. She contends that their participation in the mathematical discourses—that is their talk about mathematical objects—is a needed component for learning to occur. In addition, affordances for a change in the mathematical discourse can only occur if the students are engaged in mathematizing—that is that they are communicating about mathematical objects—and the amount and quality of the mathematizing directly correlates with conceptual learning of mathematics.

Although mathematizing is an essential component for mathematical achievement because learning is social other factors need consideration. When students are engaged in mathematical activity they may talk about mathematical objects but they also talk about other things including themselves and other students. Significant work by a group of researchers (e.g., Boaler, 2008; Cohen, 1994; Hunter, 2007; Mercer & Wegerif, 1999; Webb & Mastergeorge, 2003; Wood & Kalinec, 2012) has examined ways student talk can involve both academic and social ways of participating in mathematical activity, in recognition that particular types of these social interactions also support mathematical learning. For example, Wood and Kalinec (2012) illustrate ways in which students in small groups use different types of talk depending on their focus. These include a focus on mathematical objects (mathematizing), people (subjectifying), or their attributes (identifying). Although mathematical learning occurred Wood and Kalinec (2012) illustrated how opportunities for learning were available differently for different students, according to another group member's vision of their peers, and themselves as the perceived appointed 'teacher'.

However, students can be scaffolded by teachers to learn ways to interact and use both academic and social talk to advance mathematical achievement of all members of the small group. For example, Boaler, (2006; 2008) and Hunter (2007) illustrated the effectiveness of giving student open-ended problems and tasks which support a range of ways for group members to contribute to the group processes. Of key importance in the development of productive group processes and discourse was the emphasis placed on group member's responsibility to each other. Central to the group responsibility was the requirement that the students justify and provide valid reasoning. They were also required to actively engage and monitor their own reasoning and the reasoning of others and when confused ask questions or seek other forms of help. Webb and Mastergeorge (2003) suggest that opportunities for learning for all group members are increased when they effectively seek or provide appropriate help. They contend that help seekers need persistence and precision in their requests and helpers must not only provide clear explanations but also monitor how their response supports the help seeker's understandings. Specific forms of talk also need to be scaffolded. Without specific structuring Mercer and Wegerif (1999) showed that the most common forms of talk children used in small group activity were either disputational or cumulative;

forms of talk which are not productive in mathematical activity. But, when specific guidance is provided students develop exploratory talk; a productive form of talk which supports mathematizing.

## METHOD

The data presented in the paper is part of one of three consecutive studies which spanned six years. In the design research approach (Cobb, 2000) used, a Communication and Participation Framework (CPF) (See Hunter & Anthony, 2011) was collaboratively constructed (in the first project) and employed across all the projects. The Framework provided the teachers with a flexible and adaptive tool to map out and reflectively evaluate pathways of pedagogical actions to use, to guide the students' development of academic discourses (exploratory talk) and other forms of social talk which support mathematical learning.

The teacher reported on in this paper was involved in the second Project and was an experienced teacher. The students were largely of Pāsifika (South Pacific) ethnic groupings, their ages ranged from 8-12 years. The study was conducted in New Zealand low income urban primary schools.

The following data analysis table was adapted from Wood and Kalinec (2012, p. 113)

On-task codes	Mathematizing		Any utterance about a mathematical object.
	Subjectifying	Action oriented subjectifying	Any utterance that focuses on a person's on-task actions rather than on the person as such.
		Identifying	Any utterance about who a person is or his/her features.
	None of the above		Any utterance that was on task, but did not fall into any of the other on-task categories.
Off-task codes	Subjectifying	Action oriented subjectifying	Any utterance that focuses on a person's off-task actions rather than on the person as such.
	Identifying	Identifying	Any utterance about who a person is or his/her features.
		Blazing	Any utterance that is an exaggerated negative identification of another person or members of another's family.
	None of the above		Any utterance that is off task, but did not fall into any of the categories above.

Table 1: List of codes and descriptions

Data collection over one year included teacher and student interviews, classroom artefacts, field notes, and a large collection of video recorded lesson observations. The data reported on in this paper is based on transcriptions of the entire video recorded

lesson observations. The transcripts were split into each speaker’s turns and then further split into one or more utterances based upon the focus of the talk. To analyse the data we adapted and used parts of the coding structure employed by Wood and Kalinec (2012). We drew on the categories they used (see Table 1) to code the utterances and used this to analyse the data to provide both a quantitative and qualitative view.

This paper reports on two separate lesson observations. The first transcript is of a lesson which occurred in the second month of the study and the second transcript occurred in the tenth month of the study. Both lessons are representative of small group mathematical activity and the academic and social talk the same group of students were engaged in, in response to the on-going scaffolding provided by the teacher.

			Utterances
On-task codes	Mathematizing		41%
	Subjectifying	Action oriented subjectifying	30%
		Identifying	1%
	None of the above		2%
Off-task codes	Subjectifying	Action oriented subjectifying	
	Identifying	Identifying	14%
		Blazing	2%
	None of the above		10%

Table 2: Type and frequency of utterances during lesson 5

			Utterances
On-task codes	Mathematizing		53%
	Subjectifying	Action oriented subjectifying	41%
		Identifying	1%
	None of the above		1%
Off-task codes	Subjectifying	Action oriented subjectifying	
	Identifying	Identifying	3%
		Blazing	
	None of the above		1%

Table 3: Type and frequency of utterances during lesson 14

## RESULTS AND DISCUSSION

Table 2 and Table 3 summarise the type and frequency of utterances in the two lessons. In this section we elaborate on the different categories of interactions the students engaged in and explore how these supported or limited learning of different students. We look at what was learnt and how the talk changed across the year (represented by the two lessons).

### **Mathematizing and Action-oriented subjectifying talk**

As explained in Table 1 mathematizing talk focuses on mathematical objects while subjectifying talk focuses on people and what they are doing as part of their on-task actions. In both lessons mathematizing talk and action-oriented subjectifying talk were a clear feature of the on-task behaviour of the students. In the first transcription (See Table 2) 41% of the talk was mathematizing and 30% was subjectifying talk. The students were engaged in on-task talk 74% of small group activity. In the second transcription (See Table 3) 53% of the talk was mathematizing and 41% was action oriented subjectifying talk. The students were engaged in on-task talk 96% of the small group activity. However, there was a clear difference in the ways both forms of talk were used in the two lessons. This contributed significantly to the learning of one all students but one in particular we named Viliami.

In the excerpt which follows (of the first lesson transcription) the students used both forms of talk to make sense of what was required in the task, construct a cumulative solution strategy or to develop an explanation of the strategy they were using. On-task action oriented subjectifying talk was used by different group members to support the mathematizing.

#### **Excerpt 1: Constructing an explanation cumulatively**

The students are solving a problem that involves adding 899 and 156.

Timoti: Oh yeah, we could put 800...

Viliami: 800 plus 100

The students are mathematizing but they are doing this using cumulative talk (Mercer & Wegerif, 1999). Without listening and exploring the reasoning of other members each student adds the next step they think will work.

Timoti: Yeah but we've got to tell how we added it.

Timoti has begun to use action oriented subjectifying talk. He focuses the group on their need to explain their actions which increases all their opportunities to learn.

Timoti: See we shouldn't do that fast one, dah. 800 plus 156

Timoti is describing a different solution but the students are not actively engaged in exploring the reasoning. However, he has invited his peers to think about their shared reasoning and as a result Viliami engages in mathematizing

Viliami: That's um... what is this called? 800 plus 100. Is that place value? Like then 900 plus 90 plus 50? Where do the zeroes go now?

The students continued to talk past each other and although they were all focusing on the mathematics they did not successfully solve the problem. This excerpt illustrates the need for the students to not only mathematize but also to engage in the reasoning being used by other members of the group.

**Excerpt 2: Using exploratory talk to conceptualise a mathematical explanation**

In the following excerpt (from the second lesson transcription) (see Table 3) both mathematizing and action oriented subjectifying talk are used to engage and progress the reasoning of all members of the small group. The students are solving a problem which requires them to multiply 24 by 5. They start by sense-making what they are required to do using both mathematizing and action oriented subjectifying talk.

Viliami: 24 x 5 equals... I know, I know what to start with 20 x 4

Sela [Pointing at the numbers]: Do you understand where you got these numbers from?

Timoti and Viliami together: Yes

Timoti to Sela: Do you want me to explain where we got the numbers from?

Sela has used action oriented subjectifying talk to question the other group members and open up the talk so they can all share their understandings of the problem. This supports them to work towards a common mathematical goal.

Timoti: We got the 24 from how many corn plants Sione's Dad wanted to plant and we got our 5 from how many corn plants he planted in each row. Does anyone disagree or..?

Timoti uses the context of the problem to make the numbers experientially real which makes the problem accessible for all members of the group.

Viliami: I agree that's right

Sela: I agree too

Timoti: But you've got to say why. Why do you agree?

Sela: Because it says on the problem, cos that's, because that's how much Sione's dad wants to plant, 24 rows of corn plants. He wants 5 corn plants in each row.

Timoti presses further using action oriented subjectifying talk. Through this he establishes the responsibility of all group members to actively engage in sense making. They begin to construct an explanation using mathematizing talk. Each member uses exploratory talk to examine the ideas being constructed.

Sela [recording]: Hey why not split up the 20 from the 24 into 4 lots of 5. Do you get it? You need to be able to explain why we do one more of...

Timoti and Viliami: The 5 x 4

Viliami [pointing at the extra 5 x 4]: What does that mean?

Sela: And we have one more because of the 24 x 5. Can you show where that is so you can explain...

Viliami: I know what that means. I can see it on here because we split the 20 and then we had 4 more. But why did we split the 20...why...

Sela and Timoti together: You know because we do not know our 20 times so 5 times is the easiest.



The group continue to construct and record a conceptual explanation. Sela and Timoti push Viliami to use what Webb and Mastergeorge (2003) describe as effective help seeking behaviour. Sela directs a question at Viliami

Sela: Why did we really have to repeat five times 4?

Viliami: What's the answer?

Timoti: Come on, if you don't know the answer that means you don't know what we're doing. Do you need help? Say how we can help you.

Timoti uses action oriented subjectifying talk to model help seeking behaviour. Viliami is supported to question specifically and extend his mathematical discourse.

Viliami: Can you explain the first part to me please?

Timoti: Cos we're splitting up the 20 from the 24 into 4 lots of 5. Do you get it? You need to be able to explain why we do one more of...

Viliami [Pointing at the last 4 x 5]: What does that mean?

Sela: And we have one more because of the 24 x 5 and can you show where that is so you can explain...

Viliami [Points at the section of the recording as he speaks]: I know what that means. I can see it on here because we split the 20 and then we had 4 more.

Subsequently in large group sharing Viliami shared the strategy. He explained and justified each step of the process to the class. His learning had been durable and he now had access to a discourse to provide a conceptual explanation and justification.

## CONCLUSION

Evidence is provided in this paper of the positive outcomes for mathematics learning which can result from small group activity. In both lessons the students spent a significant time mathematizing and using socially based action oriented subjectifying talk. This form of talk was used by group members to ensure that they were all able to engage in mathematizing. The increased use of this on-task social talk illustrates the importance of teacher actions to ensure students can talk and work collaboratively as suggested by other researchers (e.g., Boaler, 2008; Cohen, 1994; Hunter, 2007; Mercer & Wegerif, 1999). The effects of teacher actions to increase both mathematizing and action oriented subjectifying talk were evident in the second lesson where the students were engaged in the mathematical discourses for more than 96% of the small group activity. The findings of this study support Sfard's (2008) contention, that participation in mathematical discourses is essential for conceptual learning.

## References

- Andriessen, J. (2006). Arguing to learn. In K. Sawyer (Ed), *The Cambridge handbook of the learning sciences* (pp. 443-459). Cambridge: Cambridge University Press.
- Boaler, J. (2006). "Opening our ideas": How a detracked mathematics approach promoted respect, responsibility, and high achievement. *Theory into Practice*, 45(1), 1-11.

- Boaler, J. (2008). Promoting 'relational equity' and high mathematics achievement through innovative mixed-ability approach. *British Educational Research Journal*, 34(2), 167-194.
- Cobb, P. (2000). Conducting teaching experiments in collaboration with teachers. In A. Kelly & R. Lesh (Eds.), *Handbook of research design in mathematics and science* (pp. 307-333). Mahwah, NJ: Lawrence Erlbaum Associates Inc.
- Cohen, E. (1994). *Designing groupwork: Strategies for the heterogeneous classroom*. New York: Teachers College Press.
- Hunter, R. (2007). Scaffolding small group interactions. In J. Watson & K. Beswick (Eds.), *Mathematics: Essential research, essential practice – Proceedings of the 30<sup>th</sup> annual conference of the Mathematics Education Research Group of Australasia* (Vol. 2, pp. 430-439). Adelaide: MERGA.
- Hunter, R. K., & Anthony, G. (2011). Forging mathematical relationships in inquiry-based classrooms with Pasifika students. *Journal of Urban Mathematics Education*, 4(1), 98-119.
- Lerman, S. (2001). Cultural discursive psychology: A sociocultural approach to studying the teaching and learning of mathematics. *Educational Studies in Mathematics*, 46, 87-113.
- Mercer, N., & Wegerif, R. (1999). Children's talk and the development of reasoning in the classroom. *British Educational Research Journal*, 25(1), 95-112.
- Sfard, A. (2008). *Thinking as communicating: Human development, the growth of discourses and mathematizing*. Cambridge, UK: Cambridge University Press.
- White, D. Y. (2003). Promoting productive mathematical classroom discourse with diverse students. *The Journal of Mathematical Behaviour*, 22(1), 37-53.
- Whitenack, J., & Yackel, E. (2002). Making mathematical arguments in primary grades: the importance of explaining and justifying ideas. *Teaching Children Mathematics*, 8(9), 524-528.
- Wood, M., & Kalinec, C. (2012). Student talk and opportunities for mathematical learning in small group interactions. *International Journal of Educational Research*, 51-52, 109-127.
- Wood, T., Williams, G., & McNeal, B. (2006). Children's mathematical thinking in different classroom cultures. *Journal for Research in Mathematics Education*, 37(3), 222-255.
- Yackel, E., Cobb, P., & Wood, T. (1991). Small-group interactions as a source of learning opportunities in second-grade mathematics. *Journal for Research in Mathematics Education*, 22(5), 390-408.

# U.S. POLITICAL DISCOURSE ON MATH ACHIEVEMENT GAPS IN LIGHT OF FOUCAULT'S GOVERNMENTALITY

Salvatore Enrico Indiogine, Gerald Kulm

Texas A&M University

*The objective of the study was to document and analyze the justifications given by federal institutions of the United States for governmental control of mathematics education as function of the achievement gaps (AGs) in mathematics. We wanted to shed light on the discourses made in the public arena that have legitimized this control and firmly established in the national conscience that the knowledge of mathematics is essential to the prosperity and survival of the nation. The research question can be briefly stated as “what insights and understandings of the national education policy discourse on the achievement gaps in mathematics does Foucault's (2009) governmentality offer?”*

## **THEORETICAL FRAMEWORK**

In the United States there are persistent and significant differences between ethnic/racial groups where students of Asian and European descent have significantly higher scores than Native American students and students of African or Hispanic descent. Side by side to these differences in race or ethnicity are the differences in wealth. The effect of disparity in income on educational outcomes is at least as incisive as the previous differences. This phenomenon has been called the “racial, ethnic, income, or national achievement gap.” The phenomenon has been subject of extensive discussions and research, especially since the publication of the report called “A Nation at Risk” in 1983 (National Commission on Excellence in Education, 1983). Research on the achievement gap is extensive, and research on the political aspects of the achievement gaps also exists (e.g. Apple, 1992; Payne & Biddle, 1999). However, there has been limited research on political discourse regarding the mathematics achievement gap (Ellis et al., 2005; Martin, 2003).

### **Foucault's governmentality**

Very little scholarly research has been published on the relationship between Foucault's governmentality and the achievement gaps (Suspitsyna, 2010). Governmentality is the process through which a form of government with specific ends (a happy and stable society), means to these ends (“apparatuses of security”), and with a particular type of knowledge (“political economy”) to achieve these ends, evolved from a medieval state of justice to a modern administrative state with complex bureaucracies (Burchell, 1991, p. 102). To analyze government is to analyze those mechanisms that try to shape, sculpt, mobilize and work through the choices, desires, aspirations, needs, wants and lifestyles of individuals and groups (Dean, 2009, p. 20). Foucault (2009, pp. 108-109) described governmentality according to three

“dimensions.” This study employed the first dimension: The “ensemble” formed by the institution's procedures, analyses and reflections, the calculations and tactics that allow the exercise of this very specific albeit complex form of power.

## **METHODS**

Our intention in the study was not to prove a phenomenon in a scientific, experimental sense. Rather it was to navigate through the documents of federal educational policy and history of education to study the motivations, whether openly stated or uncovered by analysis and to generate interpretative narratives. We attempted to understand what social, economic, military, and political conditions made those in power decide to legislate the teaching of mathematics and to increase the amount funding and regulations. The distribution of the federal budget is a ‘zero sum game.’ The decision to give money to any program or agency can only occur when the discourse that supports it becomes intelligible. When certain practices, intentions, and desires become part of the public sphere, they also become tacitly and implicitly part of the ‘normal’ functioning of society.

The data sources were documents from two branches of the federal government: Presidential speeches and Congressional hearings made up of presentations by members of Congress, witnesses, and invited experts. Parallel qualitative discourse analysis (QDA) and quantitative text mining analyses were employed. During the final stage, QDA, text mining, and literature review were integrated to construct narratives where we described, in light of governmentality, how the public discourse on the mathematics achievement gaps is structured. For a complete description of the processes of coding the discourse in the documents, carrying out data mining, and constructing the narratives, see *Indiogene* (2013).

The analysis was guided by some studies in education that were performed using the Foucauldian concepts of archaeology and genealogy; mainly Knight, Smith, and Sachs (1990) who presented their “critical appreciation of official state policies” concerning school curriculum in Australia, and Kenway (1990) who studied how certain political forces “have all but colonized popular thinking and government policy on education in Australia.” A more recent study of this type in mathematics education was performed by Popkewitz (2004). However, we also made great use of research on governmentality analysis in education such as by Doherty (2006), Suspitsyna (2010) and Goddard (2010).

## **RESULTS AND DISCUSSION**

Our examination of the data focused on highlighting several trajectories in U.S. education policy. What became apparent from the analysis of the political discourse is that in parallel to the expansion of the federal share of the education budget was the centralization of the control of education. There is a clear historical trend from local to state to federal control. Its significance should not be underestimated because this trend

contravenes a political principle that is heartfelt among U.S. citizens, local control of public affairs.

Three of the components of governmentality: procedures, analyses and reflections, and calculations and tactics, can be used to model the growth in complexity of the government's approach to the AGs. This process can be represented by an outward moving spiral as shown in Figure 1.

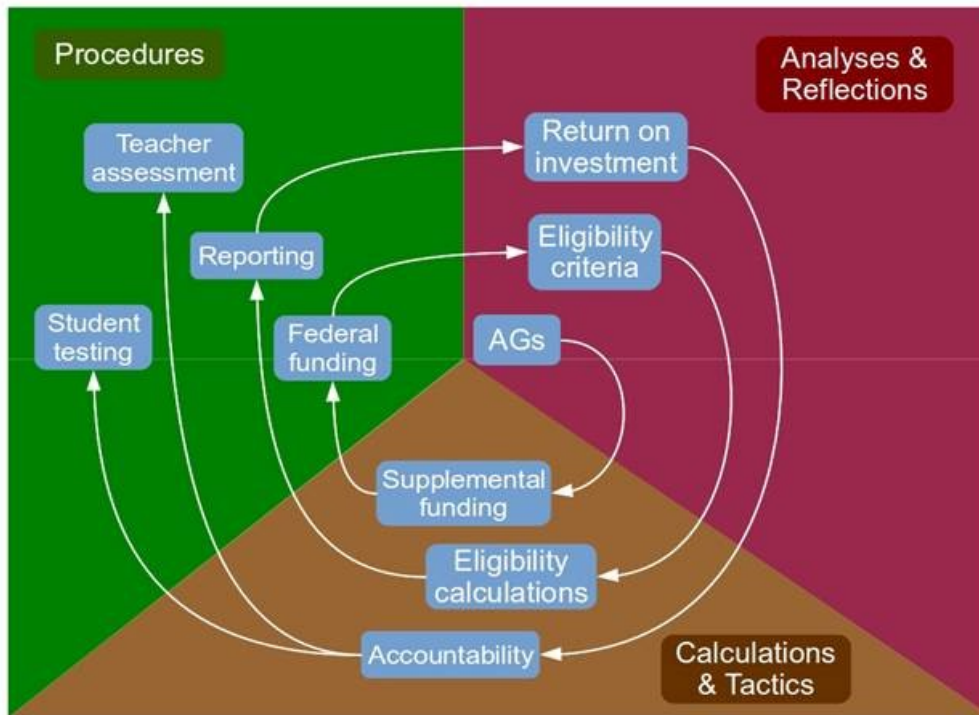

Figure 1: The Governmentality Spiral

The tactic of supplemental funding for poor schools was instituted by the “Elementary and Secondary Education Act” (ESEA) of 1965 based on the reflection of the existence and negative social and economic effects of the achievement gaps. The procedure of federal funding was instituted and the analyses for eligibility had to be established and then calculated. The process needed the establishment of reporting procedures, which created a wealth of data that allowed the analysis and reflection of the return on investment of this federal funding, which engendered, under the influence of neoliberal principles, the tactic of accountability, which demanded the establishment of elaborate procedures of student assessments. This greater level of complexity and federal control of education was legislated by the 2001 reauthorization of ESEA named the “No Child Left Behind Act” (NCLB).

The student assessments were but a starting point of an avalanche of other processes that were mandated by NCLB. The “Adequate Yearly Progress” (AYP) was calculated based on rising state goals that would bring all students to “full proficiency” in mathematics and the English language by the year 2014. The calculation of the AYP incorporates the tactic of disaggregating achievement data according to income,

language proficiency, racial, and ethnic classifications. This type of calculation is required by the analysis and reflection of the achievement gaps. If a school was deemed not to meet the requirements of AYP, it was classified as “needing improvement,” and this status would activate several procedures as can be seen in Figure 2.

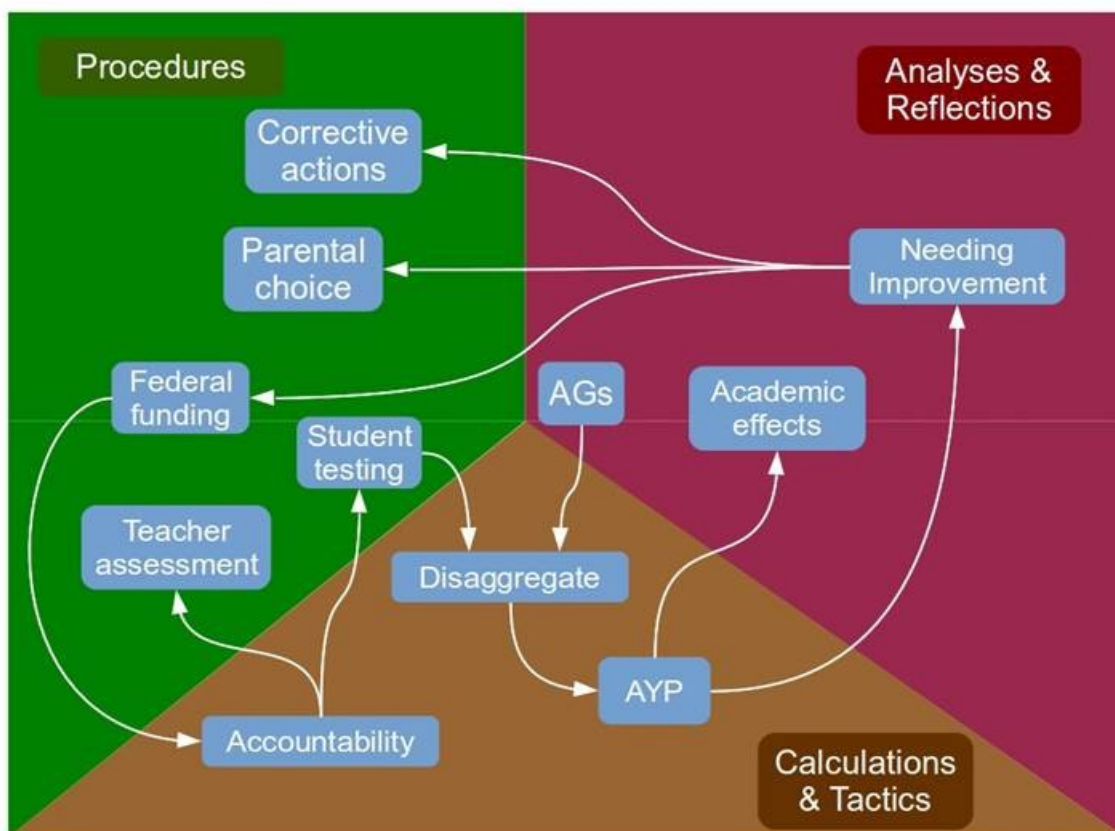

Figure 2: Accountability and its Effects

Schools and local education agencies reacted by requesting modifications to NCLB. The generic term for this request was “flexibility,” which was a term often present in the speeches by President Bush. Among these modifications was the request to adopt “growth models,” a more complex form of AYP calculation.

Looking more carefully at the analyses and reflections, we noticed that the awareness of the AGs and the acknowledgement of their importance occurred gradually over time. The shift in understanding of social justice started with ‘equal access,’ then widened its reach to ‘equal resources,’ and reached the concept of ‘equal academic outcomes’ today. Hence, the unequal academic achievements as calculated by disaggregating academic proficiency by income level, English proficiency and ethnic/racial classifications, were problematized. Another shift in analysis and reflection has been from an understanding that the AGs were caused by the social environment where the schools operated, to the understanding that the problems were ‘internal’ to the schools themselves, such as the low expectations of the teachers with respect to certain groups of students or an insufficiently rigorous curriculum.

We have also traced the analysis and reflection of the need for student assessment at a national level as connected to the tactic of accountability, which was presented initially as a tool that schools should use to improve their teaching and thus help students. Once the practice had become established and began to influence the teaching practice and the AYP rankings were made public and “corrective actions” became more widespread, it became a subject of controversy.

We then looked at the analysis and reflection of the imposition by law of “research-based education practices.” An impression was given that the teaching practices at schools were driven by tradition at best and fads at worst. The policy discourse reflected a low opinion of the professional standing of the teachers. Mention was made of the widespread use of non-certified and out-of-field teaching, especially in ‘difficult’ schools. In reality, it appeared that the reforms themselves were not based on education research but were rather ideologically driven.

The AGs could have never reached the importance that they have based only on anecdotal evidence. Policy makers needed the solid evidence provided by the statistical calculations of the student achievement data. However, these calculations became a battlefield once NCLB made them a central feature of education law. We looked at the controversies on who should be included or not in these calculations, e.g. students with special needs and English Language Learner students. Sometimes the issues were about ‘arcane’ statistical concepts such as the N-size and the how to calculate the confidence intervals. ELL students, also called Limited English Proficiency (LEP) students, pose particular statistical, and thus policy, difficulties. Unlike racial/ethnic groups, it is not intended to be a permanent situation. Schools are expected to move students out of this group into English language proficiency. At the same time new LEP students are added to this group. In this situation this subgroup would never attain proficiency. Hence several states have modified their proficiency calculations. This dynamic is but one of the many issues that make accountability for LEP students problematic. For details see Abedi (2004).

Another historical trend in education policy towards policy centralization that we have observed is the expanding federal role in the curriculum. Traditionally it was the schools and school districts what determined the content of the curricula. However, as we have noted previously, these local standards have come under attack by those who, based on an analysis and reflection, considered them not sufficiently rigorous for some students and thus contributing to the AGs. Initially the tactic of state curricula common to all students was advocated, and once this tactic was established the next step of federalization of education consisted in the “voluntary” creation of a national common curriculum.

During the period of time that we examined, one important target of analysis and reflection has become increasingly incisive and now has become the most controversial aspect of school reform. This is the issue of teacher assessment and associated punitive actions culminating in their dismissal. We looked at the connection between achievement calculations that would track individual students through time

and thus allow matching their progress to individual teachers and the heated debates about the use of these data. The usual rhetorical pattern was to introduce any type of assessment or measurement, for students, teachers, or schools as a diagnostic tool. Then, once established as a 'normal' procedure it would be used as any other business tool to 'separate the wheat from the chaff.'

We explored the Foucauldian notion of population as the target of all previous procedures, analyses and reflections, and calculations and tactics. The cornerstone of a neoliberal form of government and social intervention is the use of market forces. NCLB modified the Elementary and Secondary Education Act of 1965 by introducing mechanisms in the federal funding of schools that would open them to some form of free market through the implementation of the procedures of parental choice and the reporting of school evaluations. However, we have seen that these implementations were quite timid and thus had negligible effect, and have been superseded by the recent rise and popularity of the charter schools.

## **CONCLUSION**

According to Foucault the major form of knowledge of governmentality is "political economy." Governments had to place the national economy at the center of its activities because of the competition between nations. Basically the 'economy' is the 'policy.' We have seen how it has become a form of knowledge that the public school system is a component of the economic machinery of the nation by preparing and training the next workforce. The closing of the AGs, both national and international, are placed in the context of the U.S. economy and its international standing.

In conclusion, whether the procedures, analyses and reflections, and calculations and tactics have had a beneficial impact on the AGs is not an issue in this analysis. However, as Lee and Reeves (2012, p. 209) concluded, the narrowing of the AG was more closely associated with "long-term statewide instructional capacity and teacher resources rather than short-term NCLB implementation fidelity, rigor of standards, and state agency's capacity for data tracking and intervention." Thus, in education, measuring does not necessarily solve a problem. It may do so in business where people can be hired and fired, lines of business can be initiated or terminated, but public education as an inclusive and empowering institution does not and should not operate in this fashion.

## **References**

- Abedi, J. (2004). The No Child Left Behind Act and English language learners: Assessment and accountability issues. *Educational Researcher*, 33(1), 4-14.
- Apple, M. W. (1992). Do the standards go far enough? Power, policy and practice in mathematics education. *Journal for Research in Mathematics Education*, 23(5), 412-431.
- Dean, M. (2009). *Governmentality: Power and rule in modern society* (2<sup>nd</sup> ed.). Thousand Oaks, CA: SAGE Publications.



- Ellis, M. W., Berry, I., & Robert, Q. (2005). The paradigm shift in mathematics education: Explanations and implications of reforming conceptions of teaching and learning. *Mathematics Educator*, 15(1), 7-17.
- Foucault, M. (2009). *Security, territory, population: Lectures at the Collège de France 1977–1978*. New York: Picador.
- Indiogene, S. E. P. (2013). *The achievement gaps and mathematics education: An analysis of the U.S. political discourse in light of Foucault's governmentality* (Unpublished doctoral dissertation). Texas A & M University, College Station, TX.
- Lee, J., & Reeves, T. (2012). Revisiting the impact of NCLB high-stakes school accountability, capacity, and resources: State NAEP 1990-2009 reading and math achievement gaps and trends. *Educational Evaluation and Policy Analysis*, 34(2), 209-231.
- Martin, D. B. (2003). Hidden assumptions and unaddressed questions in “mathematics for all” rhetoric. *The Mathematics Educator*, 13(2), 7-21.
- Payne, K. J., & Biddle, B. J. (1999). Poor school funding, child poverty, and mathematics achievement. *Educational Researcher*, 28(6), 4-13.
- Suspitsyna, T. (2010). Accountability in American education as a rhetoric and a technology of governmentality. *Journal of Education Policy*, 25(5), 567-586.



# RELATING STUDENT MEANING-MAKING IN MATHEMATICS TO THE AIMS FOR AND DESIGN OF TEACHING IN SMALL GROUP TUTORIALS AT UNIVERSITY LEVEL

Barbara Jaworski<sup>1</sup>, M. Gözde Didis<sup>2</sup>

<sup>1</sup>Loughborough University, UK, <sup>2</sup>Middle East Technical University, Turkey

*In a developmental research approach, from a sociocultural position, we address the meanings students make of mathematics in teaching sessions and how this relates to the intentions of the teacher and approaches to teaching. Analyses of data come from small group tutorials of one tutor with first year university mathematics students (n=5). We exemplify using data from one tutorial which addressed concepts in calculus that first year students encounter in their lectures. We explain teaching design and an approach to implementing it, and address issues that arise in practice and how these are related to students' meaning-making of mathematical concepts. Development of 'knowledge in practice' is seen alongside that of knowledge in the public domain.*

## INTRODUCTION

In one UK university, first year mathematics students are expected to attend lectures in calculus and linear algebra. Each student is also a member of a small tutor group (of from 5 to 8 students) that works on the material of these lectures. Lecturers in the modules set problem sheets each week for students to tackle. In small group tutorials (one hour per week), the tutor works with students on material relating to the two modules, often taking questions from the problem sheets. We focus here on the activity of one tutor with her group of 5 students who are in a joint programme of *Mathematics and Sport Science*. Her main aim for tutorials is to support students to understand, or to make meaning of the mathematics of the lectures. In each tutorial the tutor makes a judgement as to which questions to focus on in the tutorial (other tutors might do things differently). For her, these questions should satisfy two conditions:

- a. they should reveal key concepts in the mathematics of the lectures – to some extent, all questions set by the lecturer do this, but the tutor chooses particular ones to highlight key concepts in her judgment;
- b. they should be questions with which students struggle or have difficulties.

A general expectation is that students will work on the problem sheets in their own time and come to a tutorial with their questions. Therefore, in every tutorial the tutor asks students to inform her of questions with which they struggle or would like help. They respond occasionally but largely they do not respond. It often seems as if they have not addressed any of the questions before coming to the tutorial. The tutor does not want to exercise too much pressure on what they have to do before coming, since they are then likely not to come. She would rather they came, so that (she hopes) some 'useful' work can be done. The tutor decides what is 'useful' based on her knowledge

of the mathematics and of her students and what they find difficult. After the tutorial, the tutor reflects on what has occurred, whether her earlier judgments were appropriate, and what alternatives there could have been.

## RESEARCH QUESTIONS

The aim of this research is to study how the practical manifestations of teaching in a tutorial satisfy the aims of *teaching for students' learning* (Jaworski, 1994; 2003b). We wish to discern as far as possible the associated meaning making of the students in a tutorial and how this is (or not) linked to the style of teaching, taking into account the wider social factors of the setting. We have three basic research questions:

1. What is the nature of the teaching manifested in the tutorials?
2. What student meanings can we discern and in what ways?
3. In what ways can we link (1) and (2) and what issues does this raise?

Through this research, we seek also to redress the scarcity of research into the “actual classroom teaching practice” of university teachers (Speer, Smith and Horvath, 2010, p. 99) and extend knowledge of teaching in small group tutorials (Jaworski 2003b).

## MEANING-MAKING IN MATHEMATICS

There is a considerable literature on mathematical meaning making at a range of levels (e.g., Kilpatrick, Hoyles, & Skovsmose, 2005). We set the scene here by drawing on three perspectives. The first links meaning making to *making connections*, both within mathematics and to the world beyond mathematics.

[M]athematical meanings derive from connections: intra-mathematical connections which link new mathematical knowledge with old and extra-mathematical meaning derived from contexts and settings which include – though not uniquely – the experiential world” (Noss, Healey, & Hoyles, 1997, p. 203).

The second suggests that making meaning in mathematics is a process of “socialisation” into the culture and values of “doing mathematics” (Ben-Zvi & Arcavi, 2001). In the third, Nardi (2008, p. 111) refers to students “mediating mathematical meaning through symbolisation, verbalisation and visualisation” suggesting that students experience the tension between the need to *appear to be*, or *to be* mathematical. Thus, making connections, the worlds of mathematics and beyond, and processes of socialisation into culture and values are all central to making meaning in mathematics. Further, students have to get beyond the instrumental use of key processes in learning mathematics to become mathematical, to make meanings at a conceptual level. We draw on all these perspectives in our analyses.

## METHODOLOGY

We take a sociocultural perspective in which knowledge is seen to develop in social settings as part of which individual sense-making develops (e.g., Wertsch, 1991). Teaching and teaching resources are seen to have a central mediating role in the

development of mathematical meanings by students. People make sense of mathematics in relation to the worlds of which they are a part; these ‘worlds’ capture local and more global situations and contexts surrounding human activity (Holland, Lachicott, & Skinner, 2001), the wider social issues mentioned above.

Our methodology is developmental: we use research as a tool to promote development as well as a tool to observe and analyse development (Jaworski, 2003a). We are two researchers: one researcher is also the tutor, whose job is to teach the students – to enable their mathematical understanding. She wants to *promote* meaning making and, at the same time, to *discern* meaning making: related aims which might potentially be in tension. The other researcher observes activity and collects data through audio recording<sup>1</sup> and note taking. In discussion with the tutor, she enables the tutor to reflect critically on the teaching process and together they seek evidence of students’ meaning making (audio-recorded). An expectation of this relationship is that the tutor, through acting as a researcher, develops knowledge in practice which feeds back into the design of teaching. Thus two kinds of knowledge are generated – knowledge in practice which informs the teaching process, and knowledge which can be communicated in the wider research community (for example through this paper).

We collected data from a series of tutorials (10 in all) in Semester 2 of the academic year. At the time of writing, analysis is in its early stages; we expect findings to develop as analysis proceeds. Briefly, the data from a tutorial is first split into episodes in which an episode is a section of the tutorial which has some completeness in itself (e.g., the work of the group on a given problem). We undertake a grounded analysis of the data, episode by episode, coding and categorising (Corbin & Strauss, 2008).

We demonstrate our analytical process through a case of one episode taken from a tutorial from Week 6 (of 12 weeks). Four (out of 5) students are present plus the tutor, and the co-researcher as observer. Lectures are currently focusing on multivariable calculus. The group works on questions from the lecturer’s problem sheet involving differentiation of functions of two variables. We focus on an episode of 10 minutes from close to the beginning of the tutorial. Our analysis is both particular to this episode and also related to analysis of other tutorials and episodes. Codes emerge continually and it is necessary to keep revisiting earlier codes in order to rationalise them with new insights. In particular we recognise the emergence of tensions in the process of teaching development. Analysis is ongoing and we expect to set these observations against those emerging from other data.

## ANALYSIS OF TEACHING

The tutor needs to find out as quickly as possible what the students already know and can do: if basic questions are answered quickly/readily, they can move on to more demanding questions. Students are usually able to tackle procedural questions, but

---

<sup>1</sup> Although video data would be valuable it is considered that use of a video camera would be too disturbing for the students.

those demanding conceptual insight cause more difficulty. She chose her first question to encourage students to *make sense of connections* between symbolisation of partial derivatives and their graphical representations, as follows:

The three graphs below show a function  $f$  and its partial derivatives  $f_x$  and  $f_y$ . Which is which and why?

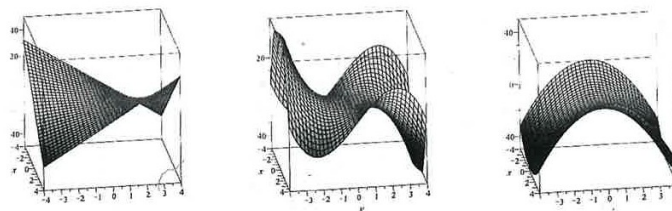

As also recognised in analysis of other tutorials, the tutor employs a questioning style. Analytical codes used previously have included ‘TQ-probing’ and ‘TQ-prompting’ to identify ‘tutor questions’ which “probe” (seek out students’ meanings) or “prompt” (suggest particular meanings). In this episode, almost every ‘turn’ of the tutor includes a question or questions to the students, so this has required a finer coding of questions. The tutor says that she is trying to find out what students know and can express, which she believes will give her insight to their understanding (or meaning-making) in mathematics. In addition she expects their responses to prompt their fellow students to think about the concepts and provide alternative or clearer answers to the questions. Thus, she hopes to encourage students’ engagement both individually and with each other. Her probes/prompts are designed to provide opportunities for students to think, express and articulate what they see and understand, and to reveal what they are not clear about. Such revealing of students’ lack of clarity or inability to express clearly, leads to the successive questions that she asks. Analysis shows the following kinds of questions being asked most frequently as prompting or probing questions:

**Meaning Questions** (Qm) or (Qmw) – *overtly* seeking students’ expression/articulation of meaning, often in response to the question “why?”

**Inviting Questions** (Qi) – asking students to respond; (Qig) – offering the question *generally* (to all students) or (Qid) *directly* to one student (named). The question can be a specific question (Qigs or Qids) or non-specific question (Qig or Qid) where ‘specific’ means that it refers to a specific mathematical item. Often these questions also seek meaning, but more implicitly.

*Do the students make sense of the particular notation?*

- 3: T: So, first of all what are these things  $f_x$  and  $f_y$ ? Alun. What is, what do you mean, if you write  $f_x$  and  $f_y$ ? [Qm] [Qids]
- 4: S:(Alun)  $df/dx$
- 5: T: And how would you write it? [Qid]
- 6: [He indicates with his hand the partial derivative symbol,  $\partial$ ]

- 7: T: Yes *partial*  $df/dx$  and similarly  $f_y$  is *partial*  $df/dy$ . When you say  $df/dx$  it's not clear, so you want to be clear. We would say here *partial*  $df/dx$  and *partial*  $df/dy$  [She writes on the board  $\partial f/\partial x$  and  $\partial f/\partial y$ ]
- 8: T: So in the question then, we have three graphs; one of them is a function  $f$  and the other two are the *partial* derivatives  $df/dx$  and  $df/dy$ . Now, which is which? [Qig]

At turns 3 and 5 we see direct and specific questions to Alun, who responds. At turn 8, there is a general question to the group as a whole. As well as the tutor's questions here, we draw attention to her emphasis on terminology and symbolism [7]. Previous tutorials have revealed the importance of ensuring that students are clear about terms and their meanings. From this interchange she sees that Alun is aware of the meanings of  $f_x$  and  $f_y$  as shown by his words and gestures. Her reiteration, at turn 7, can be seen as emphasis for the other students.

*What sense are the students making of what they see?*

- 12: T: ... OK, how about you Erik? [Qid]
- 13: S: (Erik) not really sure but I guess that, er,  $f$  will be the middle one.
- 14: T: OK, *why* do you think that? [Qmw] [Qid]
- 15: S: (Erik) because it is got the, er, the slants of the first one, and the...
- 16: T: so you're seeing a relationship between the one in the middle and the other two. What do you mean by the *slants*? [Qm] [Qids]
- 17: S: (Erik) er, I don't know, just the, the gradient there.
- 18: T: *if* you're right and the function is the middle one, erm, before we go any further, Alun, do you think the function is the middle one or would you say one of the others? [Qids]
- 19: S: (Alun) it looks like the more complex

Here we see direct questions to Erik and Alun [12 & 18] and a *why* question to Erik [14]. Erik offers the key word 'slants' which the tutor asks him to clarify. It is 'key' because it is suggestive of meaning, which the tutor seeks to clarify so that it gains more general meaning for the group. As result of further questions, Alun offers the term 'complex', which the tutor goes on to pursue, in a similar style in turns 20 to 32. We pick up the dialogue again at turn 33 where the questioning continues.

- 33: S: (Brian): Well, I guess when you differentiate, you're almost simplifying it to your next .[inaudible]
- 34: T: OK, so if what we have got is, in some sense a polynomial, then when we differentiate a polynomial we get a lower degree. [Pause – looking at students] So is that what you meant by 'simplifying'? So is everybody agreed then that the middle one is the function? OK. It is!! It is. So look to the one on the right, Erik, and tell me how the one on the right fits with what you see in the middle. Is that going to be the partial derivative  $f_x$  or is it going to be the partial derivative  $f_y$ ? [Qids]
- 35: S: (Erik) erm, derivative of  $x$  [inaudible]

- 36: T: Can you say why? [Qmw]
- 37: S: (Erik) aah.. because, I dunno, it looks as if [inaudible] along  $x$  and the other as if it kind of moving up and down  $y$  [inaudible]
- 38: T: so you are changing your mind? [they laugh] How about you Alun? [Qid]
- 39: S: (Alun) erm [long pause] I dunno.
- 40: T: Well, let's suppose that is  $f_x$  as Erik said. What does it mean for it to be  $f_x$ . I mean, if I have a function such as *this* [points to the middle graph], and I am looking to find  $f_x$ . What do I *do*?. It is as if *what*? [Qig]
- 41: S: (Alun) You fix  $y$

### ADDRESSING RESEARCH QUESTIONS

Question 1 has been addressed (briefly) above. In relation to Question 2, analysis points to lines 6, 15, 17, 37 and 41 as indicative of student meaning. The articulation (or gesturing) gave clues to students' insights in relation to the problem. Students' difficulties to express their thinking in articulate forms meant that meanings were hinted at rather than uttered with clarity. We might say there is evidence of students linking the nature of the first and third graphs to the one in the middle and using informal language to express meaning (e.g., 16: *slants*; 37: *as if it kind of moving up and down y*); the need to "fix  $y$ " in order to find  $f_x$ . At this stage in the process of meaning-making, nothing formal was expressed or written down.

In a presentation of the above data in a seminar in the UK, it was suggested that the tutor is *funnelling* the discussion (Bauersfeld, 1988), prompting students so that they are giving her what they perceive she wants, and that in fact the students have little understanding of the concepts involved. Such interpretation points to the Topaz Effect (Brousseau, 1985) or Didactic Tension (Jaworski, 1994; Mason, 2002) in which a teacher's questions lead students to give correct answers without the understanding the teacher wants. Thus, discerning meanings is important to judging such interpretation.

By conducting a finer (discourse) analysis (of the third short extract above, taking it turn by turn), we show how we try to address such issues concerning meaning making and the influence of the teaching style. After Alun's statement at 19, the tutor pressed the students to say what it means for the function to appear 'more complex', to say "WHY" it would be more complex. The other students agreed with Alun's statement about complexity, but could not say why. At 33, Brian offers a new idea, that differentiation simplifies a function, resulting in a function *simpler* at the next stage. The tutor picks up and extends this idea [34] recognising that such simplification could happen in differentiating a polynomial function to obtain a function of lower degree. This is tutor input; she knows that the students are familiar with these concepts and seeks to remind and consolidate. Her question "So is that what you meant by 'simplifying'?" is somewhat rhetorical: she looks at them all and judges their response to it through body language and facial expressions which the audio data cannot capture. This leads to her acknowledgement that they are right about the middle graph



representing the required function. There is also a sense of pace, and of needing to move on. Her next question is a direct prompt to Erik, challenging him to declare which derivative the right hand graph represents. He suggests  $f_x$ , and the tutor again asks ‘why?’. He struggles to answer, but speaks of ‘movement’ along  $x$  or ‘up and down’  $y$ . These words suggest meaning to the tutor. She asks another student (Alun) to comment, and he is unable to do so. She then follows up [40] with more direct questions, building on Erik’s suggestion. This might be seen as ‘funnelling’. However, there is an issue of what to do at this point – she could just tell them the answer, giving her own explanation; instead she pursues the questioning approach. Alun’s response, “*You fix y*”, seems to be prompted by her “*What do I do*”. The use of pronouns, I and you, makes the situation more personal. They have talked about fixing  $x$  or  $y$  in order to get partial derivatives on an earlier occasion, so there are shared meanings. She knows that he knows about fixing a variable, so the fact that he brings in the idea at this point (albeit in response to her prompt) suggests to the tutor that he is starting to make sense of the various ideas (we see elements of verbalisation and visualisation although not yet the formal stage of symbolisation – Nardi, 2008).

There are dangers in a teacher analysing her own discourse with students, it being tempting to read more into events than was actually evident. However, meaning making for the tutor, trying to make sense of her students’ meanings, is informed by the wider social setting: nuances of tone, gesture and body language more generally as well as historical common experiences and wider social perception. She has had conversations with individual students (for whom she is personal tutor) about their work, progress and social activity. The fact that these students are sport scientists as well as mathematicians brings additional factors to consider – they have less time to give to their mathematics than students who study only mathematics, and have given many indications previously of struggling with mathematical concepts.

## THE NATURE OF KNOWLEDGE

The case explored above offers some early insights into a relationship between students’ meaning making and the teaching approach. Students respond only tentatively to the tutor’s questions; responses are not articulate; it is hard to gain insight to what they understand. It is important for students to be able to explain not only *what* they see, but *why* it is so. Repeatedly asking ‘why’ is a form of *socialisation*: in mathematics we need to be able to explain what we do in conceptual terms. However, we need words to explain difficult ideas – expressing informally can lead to more formal articulation. Students are unused to such expressing. Creating opportunity for them to think and express is an important part of the questioning approach. In this episode, unlike some others, there was little dialogue between students. Analysis shows the tutor where such dialogue would be valuable and prompts consideration of where and how it could have been achieved. The tutor recognises tensions: in some cases it might seem more appropriate to offer her own explanations from which students can gain insights; however, students’ reliance on the tutor giving explanations may inhibit further their willingness to try for themselves. Such growth of awareness

for the tutor is the basis of *knowledge in practice* which informs future action. As we analyse further we expect to be able to crystalize elements of, for example, the questioning approach and its relations to meaning-making. This can contribute to a broader awareness of how we encourage students' meaning-making and the issues and tensions involved. Such shared knowledge can lead to more informed practice widely.

## References

- Bauersfeld, H. (1988). Interaction, construction and knowledge: Alternative perspectives for mathematics education. In D. A. Grouws, T. J. Cooney, & D. Jones (Eds.), *Effective mathematics teaching* (Vol. 1, pp. 27-46). Reston VA: NCTM.
- Ben-Zvi, D., & Arcavi, A. (2001). Junior high school students' construction of global views of data and data representations. *Educational Studies in Mathematics*, 45, 35-65.
- Brousseau, G. (1984). The crucial role of the didactical contract in the analysis and construction of situations in teaching and learning mathematics. In H. G. Steiner (Ed.), *Theory of mathematics education* (pp. 110-119). Bielefeld, Germany: Universitat Bielefeld/IDM.
- Corbin, J., & Strauss, A. (2008). *Basics of qualitative research: Techniques and procedures for developing grounded theory* (3<sup>rd</sup> ed.). London: Sage.
- Goodchild, S. (2008). A quest for "good" research. In B. Jaworski & T. Wood (Eds.), *International handbook on mathematics teacher education* (Vol. 4., pp. 201-220). Rotterdam, The Netherlands: Sense Publishers.
- Holland, D., Lachicott, W., Skinner, D., & Cain, C. (2001). *Identity and agency in cultural worlds*. London: Harvard University Press.
- Jaworski, B. (1994). *Investigating mathematics teaching*. London: Falmer Press.
- Jaworski, B. (2003a). Research practice into/influencing mathematics teaching and learning development: Towards a theoretical framework based on co-learning partnerships. *Educational Studies in Mathematics*, 54(2-3), 249-282.
- Jaworski, B. (2003b). Sensitivity and challenge in university mathematics tutorial teaching. *Educational Studies in Mathematics*, 51, 71-94.
- Kilpatrick, J., Hoyles, C., & Skovsmose, O. (Eds.). (2005). *Meaning in mathematics education*. London: Springer.
- Mason, J. (2002). *Researching your own practice: The discipline of noticing*. London: Routledge.
- Nardi, E. (2008). *Amongst mathematicians: Teaching and learning mathematics at university level*. New York: Springer.
- Noss, R., Healy, L., & Hoyles, C. (1997). The construction of mathematical meanings. *Educational Studies in Mathematics*, 33, 203-233.
- Schon, D. (1987). *Educating the reflective practitioner*. Oxford: Jossey Bass.
- Speer, N. M., Smith, J. P., III, & Horvath, A. (2010). Collegiate mathematics teaching: An unexamined practice. *Journal of Mathematical Behavior*, 29(2), 99-114.
- Wertsch, J. V. (1991). *Voices of the mind*. Cambridge, MA: Harvard University Press.

# A CASE STUDY OF CONFLICTING REALIZATIONS OF CONTINUITY

Gaya N. Jayakody

Simon Fraser University

*In this paper I present a case study to illustrate conflicts between different 'realizations' of the concept of 'continuous function' held by a university first year student. Sfard's commognitive framework is used in the analysis of a student's work on continuity. I point out how these conflicting realizations have arisen from the inconsistent definitions presented in text books and other mathematical resources. The study also points to the need of extending the notion of "commognitive conflict" in the framework.*

## BACKGROUND AND THEORETICAL FRAMEWORK

This paper reports on a phenomenon identified in the second stage of data analysis of a larger study. The study is guided by the research question "what are the effects of different definitions of 'continuity of a function' on student learning?" The concept of 'continuity' has been recognized as a difficult topic in Calculus and many studies have been done on student understanding of the concept and how students make relations between continuity and other Calculus topics (e.g.: Bezuidenhout, 2001; Vinner, 1987; Cornu, 1991; Aspinwall et al., 1997). In an analysis of text books and other mathematical resources that was carried out as part of the current study, two issues were identified pertaining to definitions of continuity that are inconsistent with each other. These two problematic situations are described in the succeeding section. It was found in the first stage of the current study that university first year students have difficulties in determining whether a function is continuous or not when the function is not defined on an interval in particular. What is reported in this paper is the tension displayed in the discourse of a particular participant when she was trying to determine whether a particular function was continuous or not. I discuss how these tensions or rather 'conflicts' are arising from the inconsistent definitions of continuity.

The familiar notion of 'cognitive conflict' has been attended to by many mathematics education researchers (e.g.: Zazkis & Chernoff, 2006; Tall, 1977; Tirosh & Graeber, 1990). The notion has relations to Piaget's equilibration theory, Festinger's theory of cognitive dissonance, and Berlyne's theory of conceptual conflict (Stylianides & Stylianides, 2008). A cognitive conflict is said to be "invoked when a learner is faced with contradiction or inconsistency in his or her ideas" (Zazkis & Chernoff, 2008, p. 196).

However, with the new directions taken in looking at 'thinking' in the recent years from cognitive theories towards discursive theories, my study is informed by Sfard's commognitive theory and its interpretation of 'conflict'.

Sfard (2008) unifies thinking and communication as commognition. In the commognitive framework, thinking is conceptualized as an individualized version of interpersonal communication. With the visioning of Mathematics as a discourse, it is claimed to be an autopoietic system that creates the objects of its study. Hence mathematical objects are discursive objects and students personally construct these mathematical objects which can be represented as ‘realization trees’. A realization tree shows the different realizations of a particular signifier where a signifier is a word or symbol that acts as a noun in the mathematical discourse. A realization is a perceptually accessible thing so that narratives about the signifier can be translated into narratives about the realization. Sfard coins “commognitive conflict” as “the encounter between interlocutors who use the same signifiers (words or written symbols) in different ways or perform the same mathematical task according to differing rules” (Sfard, 2008, p. 161). What this paper reports on is different from ‘commognitive conflict’, in that the conflict is between different realizations (for the same signifier) of the *same* individual.

What follows is a brief introduction to the problems regarding definitions of continuity which has a direct relation to the case study of conflicting realizations.

## CONTINUITY: TWO DEFINITIONS

### Problem 1: Inconsistent definitions

In the context of an introductory calculus course, and also in many other common resources, the definitions used for continuity related concepts are the limit definitions. There are two different limit definitions (that are labelled as D1 and D2 for reference in this paper) used for “continuity at a point” (and accordingly “discontinuity at a point”) on which the other related concepts of continuity can be based on. Below are the two definitions.

D1 (e.g.: Stewart, 2012; Tan, Menz, & Ashlock, 2011)

A function  $f$  is said to be continuous at  $c$  if,

1.  $f(x)$  is defined at  $x = c$
2.  $\lim_{x \rightarrow c} f(x)$  exists.
3.  $\lim_{x \rightarrow c} f(x)$  is equal to  $f(c)$

$f$  is discontinuous if any of the above conditions are not satisfied.

D2 (e.g.: Stahl, 2011; Strang, 1991)

A function  $f$  is said to be continuous at  $x = c$  in its domain if,

$$\lim_{x \rightarrow c} f(x) = f(c)$$

And  $f$  is discontinuous at  $x = c$  in its domain if,

$$\lim_{x \rightarrow c} f(x) \neq f(c)$$

The deciding factor that makes a definition consistent with either D1 or D2 is the treatment of a point at which the function is not defined. According to D1, a function that is not defined at a point is discontinuous at that point, while according to D2 the question of continuity or discontinuity shouldn't arise.

A 'continuous function' too is defined in two ways where one is in accordance with D1 while the other one is in accordance with D2.

D1 (e.g.: Anton, 1995; Mathematics Harvey Mudd Collage, n.d.)

A function is a continuous function if it is continuous at every real number.

D2 (e.g.: Strang, 1991; Bogley & Robson, 1996)

A function is a continuous function if it is continuous in its domain.

### **Problem 2: Absence of a definition for 'a continuous function'**

I have examined several dozen of resources (textbooks, websites, mathematical dictionaries) seeking a definition for a 'continuous function'. In most of the resources such a definition was not explicitly stated. However, the phrase 'continuous function' is loosely used in many places.

The topic of continuity starts off, in many textbooks and websites, with the definition of 'continuity *at a point*' (e.g.: Stewart, 2012). This definition is the leading definition and other related extensions to the concept of continuity of a function, each of which has its own definition may follow (e.g.: continuity on an interval, types of discontinuities, one-sided continuities).

However, the heart of the second problem is that these definitions of continuity/discontinuity at a point are not followed by the definition of a *continuous function* (e.g.: Neuhauser, 2011; Stewart, 2012). This situation leaves room for students, if not explained by the instructor, to intentionally or unintentionally 'construct' a meaning for "continuous function". Instinctively it is likely that this will be interpreted as "continuous everywhere" with 'everywhere' to mean either "all reals" or "domain". Therefore this situation holds the potential to lead students to construct their own meaning for a 'continuous function', which could be in discord with the intended definition.

### **METHODOLOGY**

My data comes from the ongoing research study. The case study I'm presenting is of a first year university student, student 'J', who takes an introductory Calculus course. She was given a questionnaire where she was asked to give the definitions for "continuity at a point" (which she had learnt in the course) and "continuous function" (which she was not taught in the course) and then was given 6 functions in their graphical form to be identified as continuous or discontinuous. Then she was interviewed one on one to discuss her responses.

The first four graphs, which are discussed in the excerpt, are given in Table 1. Note that the domain for graph D was specified.

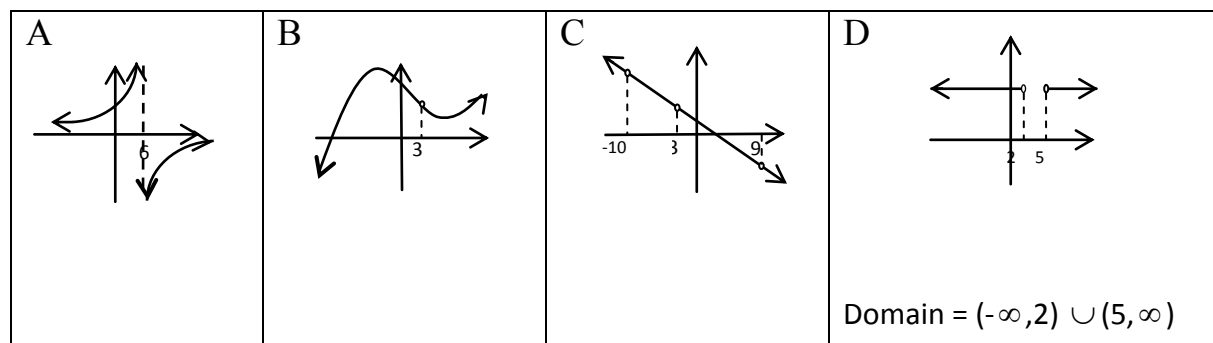

Table 1: The first four graphs in the questionnaire

## RESULTS AND ANALYSIS

A realization tree for ‘a continuous function’ for ‘J’ was constructed based on her responses to the questionnaire and her utterances in the interview. Among other realizations, it was found that, ‘J’ had the following two realizations for a continuous function.

X: For every point  $c$  in its domain,  $f(c)$  is defined and  $\lim_{x \rightarrow c} f(x) = f(c)$ .

[this is in accordance with D2]

Y: A function that does not have holes or asymptotes. [this is in accordance with D1]

Following (Table 2) is an interpretative elaboration (“*interpretative elaboration* is a text that, utterance by utterance, elaborates on the text produced by the interlocutors” (Sfard, 2008, p. 139)) of an excerpt from the interview with ‘J’ that illustrates the tension between these two realizations. A word that is stressed by an interlocutor is indicated by bold letters. ‘G’ is the researcher who conducted the interview.

‘J’ faces this tension when trying to decide the continuity of the graph D that is not defined on an interval.

No.	Who said	What was said	What was done	Interpretative elaboration
118	G	Umm, so here you <b>refrain</b> from saying that it is..	Pointing to graph D	‘G’ is pointing out that even though ‘J’ has clearly classified graphs A, B and C as “not continuous”, she refrained from classifying graph D as “not continuous” but just stating the “discontinuities”.
119	G	Here you said no, no, no	Pointing to graphs A, B & C	
120	G	But here you are just saying ‘there is a discontinuity’	Pointing back to graph D	
121	J	Yeah		

122	G	At $x$ equals 2 <b>and</b> $x$ equals 5		'G' stresses on 'and' because 'J' did not classify the whole interval from 2-5 as a discontinuity but only 2 <b>and</b> 5.
123	J	Yeah I wasn't		'J' admits that she avoided this classification in graph D
124	G	Can you explain that to me?		
125	J	I wasn't sure; I did this question for like three minutes...		'J' specifying three minutes for graph D implies that she took <i>more</i> time for it than she took to do each of the graphs A, B and C. By saying she took 3 minutes and admitting she wasn't sure of this she's implying that it was challenging to her.
126	G	Ohh		
127	J	Because...and then I went back and looked at the definition and I saw that it was like within the domain that it's given..	Pointing to the definition which is realization A	This is the first graph for which she refers to the definition (X). She did the first three without referring to the definition. And now, she pays attention to the domain because now the domain is "given". And the definition mentions about the domain.
128	G	Hmmm?		
129	J	And then I was like.. oh but there is like a.. open circles...it should be.....		'J' says "but there is like a.. open circles". She uses 'but' because to her, open circles, as in graphs B and C, mean 'discontinuities' (Y) but she's trying to say that they are not in the domain (X). In other words, this utterance could be reworded as "the function should be continuous according to the definition (X) <b>but</b> since there are open circles the function has discontinuities (Y)"
130	J	...	Thinking for 2 seconds	The pauses taken to think shows how much she is struggling to decide because there is a battle between two realizations she has for continuity.
131	J	There is a...there is no...umm...		The two utterances "there is a" and "there is no" that take place adjacently clearly indicates the

				conflicting conclusions about continuity of function D resulted through the two different realizations.
132	J	I don't know because it's not con... like within the domain.. it's not a square bracket		'J' wants to say that the function is not continuous ('not con...') but she is stuck because the two points 2 and 5 are not in the domain ('not a square bracket')
133	G	Yeah		
134	J	So it's not...	Pauses	'J' really wants to say it is not continuous and this shows that for her, realization B is stronger than A.
135	G	So		
136	J	I don't really know		'J' is utterly confused and gives up. She doesn't seem to be aware that the confusion stems from two different realizations.

Table 2: Interpretive elaboration for Jennifer's utterances from 118 to 136 that elaborates a conflict between the realizations X and Y for continuity

The tension between the two realizations X and Y which are based on the two inconsistent definitions D1 and D2 is clearly visible in 'J's utterances. She had learnt D1 as the definition for 'continuity at a point' in her class. She did not have any problem in deciding the continuity of the first three graphs as these were familiar graphs to her that she had often come across in the class. And as she admitted in the interview she did not refer to the definition in deciding whether they were continuous or not. This was an immediate realization (Y) for the signifier 'continuous function' for her that included familiar features that she had seen in functions that were not 'continuous'; holes and asymptotes. The unfamiliarity of the graph D, one with a discontinuity on an interval, pushed her towards the realization X which is the definition she had taken from a website which is consistent with D2. The realization procedure for X, however, which was not an immediate one, required her to analyze the domain. At this point, 'J' was torn between the two realizations as the two realizations would take her to different conclusions about the continuity of the graph which resulted in a constant conflict in her utterances. This is a commognitive conflict between two of her own realizations for the signifier 'continuous function'.

## DISCUSSION

The case study presented in the paper illustrates the rise of conflicts between different realizations for the same signifier when a student is confronted with an unfamiliar situation. This observation points to the need for an extension to the notion of "commognitive conflict" to encompass the conflicts between realizations for the same



signifier of the *same* individual. I have also attempted to frame these conflicting realizations as arising from nothing but the inconsistent definitions used for continuity; a concern that is seen to be present in textbooks, mathematical websites, or even arguably within classroom instruction and discourse.

As discussed, while there are inconsistencies in the way continuity of a function at a point is defined there is both ambiguity and inconsistency in explaining, let alone defining, what ‘a continuous function’ is.

In conclusion, I believe, apart from being aware of these problems that exist in electronic as well as in print resources that teachers and learners should have a clear picture of the issue and its roots so that they will at least be able to deal with ‘continuity’ problems according to the particular chosen definition. The study also gives evidence to the problematic situations that students are led to due to implied definitions that are not explicitly stated or taught. Hence, perhaps more importantly, what this study suggests in particular is that we also need to make a shift in our choices from a mathematical one to a pedagogical one when it comes to choosing definitions and making decisions about the kind of discourse we model in the classroom.

## References

- Anton, H. (1995). *Calculus with analytic geometry* (5<sup>th</sup> ed.). New York, NY: Wiley and Sons, Inc.
- Aspinwall, L., Shaw, K. L., & Presmeg, N. (1997). Uncontrollable mental imagery: Graphical connections between a function and its derivative. *Educational Studies in Mathematics*, 33(3), 301-317.
- Bezuidenhout, J. (2001). Limits and continuity: Some conceptions of first-year students. *International Journal of Mathematical Education in Science and Technology*, 32(4), 487-500. doi: 10.1080/00207390010022590
- Bogley, W., & Robson, R. (1996). *Calculus quest: The definition of continuity*. Retrieved from <http://oregonstate.edu/instruct/mth251/cq/Stage4/Lesson/continuity.html>
- Cornu, B. (1991). Limits. In D. Tall (Ed.), *Advanced mathematical thinking* (pp. 153-166). Dordrecht, Kluwer Academic.
- Mathematics Harvey Mudd College. (n.d.). *HMC Mathematics online tutorial: Continuity*. Retrieved from <http://www.math.hmc.edu/calculus/tutorials/continuity/>
- Neuhauser, C. (2010). *Calculus for Biology & Medicine* (3<sup>rd</sup> ed.). Upper Saddle River, NJ: Pearson Education, Inc.
- Sfard, A. (2008). *Thinking as communicating: Human development, the growth of discourses, and mathematizing*. New York: Cambridge University Press.
- Stahl, S. (2011). *Real analysis: a historical approach* (2<sup>nd</sup> ed.). New Jersey: Wiley.
- Strang, G. (1991). *Calculus*. USA: Wellesley-Cambridge Press.
- Stylianides, G. J., & Stylianides, A. J. (2009). Facilitating the transition from empirical arguments to proof. *Journal for Research in Mathematics Education*, 40(3), 314-352.

- Tall, D. (1977). *Cognitive conflict and the learning of mathematics*. Paper presented at the first conference of the International Group for the Psychology of Mathematics Education, Utrecht, The Netherlands.
- Tan, S., Menz, P., & Ashlock, D. (2011). *Applied Calculus for the managerial, life, and social sciences*. Scarborough, ON: Nelson Education Ltd.
- Tirosh, D., & Graeber, A. O. (1990). Evoking cognitive conflict to explore preservice teachers' thinking about division. *Journal for Research in Mathematics Education*, 21(2), 98-108.
- Vinner, S. (1987). Continuous functions-images and reasoning in College students. In J. G. Bergeron, N. Herscovics, & C. Kieran (Eds.), *Proc. 11<sup>th</sup> Conf. of the Int. Group for the Psychology of Mathematics Education* (Vol. 2, pp. 177-183). Montreal, CA: PME.
- Zazkis, R., & Chernoff, E. J. (2006). Cognitive conflict and its resolution via pivotal/bridging example. In J. Novotná, H. Moraová, M. Krátká, & N. Stehlíková (Eds.), *Proc. 30<sup>th</sup> Conf. of the Int. Group for the Psychology of Mathematics Education* (Vol. 5, pp. 465-472). Prague: PME.
- Zazkis, R., & Chernoff, E. J. (2008). What makes a counterexample exemplary? *Educational Studies in Mathematics*, 68(3), 195-208.

# AN ANALYSIS OF MATHEMATICAL PROBLEM-POSING TASKS IN CHINESE AND US REFORM TEXTBOOKS

Chunlian Jiang<sup>1</sup>, Jinfa Cai<sup>2</sup>

<sup>1</sup>University of Macau, <sup>2</sup>University of Delaware

*This study analyzed the problem-posing tasks in Chinese and U.S. elementary mathematics textbooks. Significant differences were found between the Chinese and U.S. textbooks in the presentation of problem posing activities. By analyzing problem posing in textbooks, we gain insight into how reform ideas are reflected in the mathematics curriculum. With respect to problem posing itself, it would appear that the curriculum reform has moved problem-posing tasks into greater prominence, but great effort is needed to make problem posing a reality in both curriculum and instruction. In fact, our analysis shows that even in these reform textbooks, the proportion of problem posing tasks is very small.*

## INTRODUCTION

In the past several decades, there have been efforts around the world to incorporate problem posing (PP) into school mathematics at different educational levels (e.g., Brink, 1987; Chinese Ministry of Education, 1986; Hashimoto, 1987; Healy, 1993; Keil, 1964/1967). In recent years, there appears to have been a high level of interest among many researchers and practitioners in making problem posing a more prominent feature of classroom instruction (Singer, Ellerton, & Cai, 2013).

If problem-posing activities are to play a more central role in classrooms, they must be more prominently represented in curricula. Similarly, if teachers are to engage students in problem posing in the classroom, they must have sources for problem-posing activities. In fact, education reform movements have recommended that problem-posing activities be included in mathematics curricula themselves. Internationally, school mathematics reforms have recommended that students be able to “formulate interesting problems based on a wide variety of situations, both within and outside of mathematics” (NCTM, 2000) and that instructional activities should emphasize learning problem-posing skills.

Similarly, reforms to curriculum standards in China have increased the prominence of problem posing. The 9-year compulsory education mathematics curriculum standards call for providing students opportunities to pose problems, understand problems, and apply the knowledge and skills learned to solve real-life problems (Chinese Ministry of Education, 2001). Similarly, the curriculum standards for senior high school mathematics also call for developing students’ abilities to pose, analyze, and solve problems from mathematics and real life (Chinese Ministry of Education, 2003). Indeed, in the reform standards, students are encouraged to discover and pose problems in order to prepare them to think independently and be inquirers.

However, the implications for the inclusion of problem posing in the curriculum are not necessarily clear. This ambivalence is reflected in the available research on problem posing and curricula. Although reform movements have called for problem posing activities to be included in mathematics curricula, there has not yet been a substantial body of research examining whether and how curricula incorporate problem posing. The purpose of this study is to analyse problem-posing tasks included in a Chinese reform elementary school curriculum and a U.S. reform elementary school curriculum.

There are at least three reasons why we undertook this study. First, we simply wanted to know if textbooks included problem-posing tasks and the kinds of problem-posing tasks that were included. Second, problem-posing activities are usually cognitively demanding tasks (Cai & Hwang, 2002). Whether it involves generating new problems based on a given situation or reformulating an existing problem, problem posing often requires the poser to go beyond problem-solving procedures to reflect on the larger structure and goal of the task. As tasks with different cognitive demands are likely to induce different kinds of learning (Doyle, 1983), the high cognitive demand of problem-posing activities can provide intellectual contexts for students' rich mathematical development. Such activities can promote students' conceptual understanding, foster their ability to reason and communicate mathematically, and capture their interest and curiosity (NCTM, 1991). Thus, an analysis of problem-posing tasks in textbooks would provide one perspective to show the learning opportunities for students through problem posing. Third, problem-solving processes often involve the generation and solution of subsidiary problems (Polya, 1957). Thus, the ability to pose complex problems should allow for more robust problem-solving abilities (e.g., Cai & Hwang, 2002). Encouraging students to generate problems is therefore not only likely to foster student understanding of problem situations, but also to nurture the development of more advanced problem-solving strategies.

## SELECTION OF TEXTBOOKS AND ANALYSIS

We chose *Investigations in Number, Data, and Space* (TERC, 2008a, 2008b, 2008c, 2008d, 2008e, 2008f) as the U.S. reform textbooks. This textbook series was developed based on the NCTM Standards (NCTM, 1989) with the support of the U.S. National Science Foundation. We chose the elementary mathematics textbook series published by Beijing Normal University (BNU) (BNU, 2001 to 2006), which was developed based on the Standards published in 2001 (Chinese Ministry of Education, 2001).

In analysing the problem-posing tasks, we first identified all of the tasks involving problem posing in both textbook series. As long as the task required students to pose a problem based on a situation or an operation, we identified it as a problem-posing task. Then we analysed these problem-posing tasks along three dimensions: (1) grade levels; (2) content areas; and (3) types of problem-posing tasks. We describe these dimensions in detail in the results section. In addition to these three aspects, we also paid attention

to whether there was the inclusion of pictorial, graphical, or tabulated (PGT) representations in the PP tasks and whether sample questions were included for students in the PP tasks.

## RESULTS

### Number of Problem-Posing Tasks

Grade	Chinese – BNU		US -- Investigations	
	Total tasks	% PP	Total tasks	% PP
1	570	5.96	490	0
2	549	5.65	741	1.62
3	541	2.77	832	0.96
4	561	2.85	760	2.24
5	619	2.91	726	3.17
6	545	3.12	-- <sup>[1]</sup>	--
Total	3,385	3.87	3,549	1.69

<sup>[1]</sup> The Investigations series does not have Grade-6 textbooks.

Table 1: Percentage of problem-posing tasks in each grade

The Chinese textbook series has a total of 131 PP tasks, while the U.S. textbook series has 60 PP tasks. The total number of problems and the percentage of PP tasks in the two textbook series are shown in Table 1. For both the Chinese and U.S. textbook series, the percentages of PP tasks are quite small. However, there is a larger percentage of PP problems in the Chinese textbook series than that in the US textbook series (3.87% vs. 1.69%;  $z = 5.54, p < .001$ ). There are similar trends between the two textbook series for first grade ( $z = 5.50, p < .001$ ), second grade ( $z = 3.98, p < .001$ ), and third grade ( $z = 2.56, p < .05$ ). There is no difference in terms of the percentages of problem-posing tasks in the fourth and fifth grades. There are also some observable differences in terms of percentages of PP tasks across grade levels. For the *Investigations* series, the fifth grade has the highest percentage of PP tasks, but the Chinese series has the highest percentage in the first grade.

### Problem-posing Tasks in Content Areas

In this part of the analysis, we focused on the 131 PP tasks in the Chinese textbook and the 60 PP tasks in the U.S. textbook. We coded the tasks in terms of the five content strands: Number and Operations, Algebra, Geometry, Measurement, and Data Analysis and Probability. In the Chinese textbook series, there are some PP tasks which do not neatly fit into a content area, such as “what mathematical problems could you find in your life?” About 18% of the 131 PP tasks are of this kind. However, in the U.S. textbook series, there are none of this type of PP task. Table 2 shows the percentage distributions of the PP tasks in the five content areas. While the majority of

problem-posing tasks are related to Number and Operations in both series, there is a significant difference between the two textbook series with respect to the percentage distribution of problem-posing tasks in the five content areas ( $\chi^2(5, N=191) = 31.67, p < .001$ ). In addition, the percentage of the PP tasks in Number and Operations in the U.S. series is significantly higher than that in the Chinese textbook series ( $z = 2.35, p < .05$ ). For the Chinese textbook series, the second highest percentage of problem-posing tasks was related to data analysis and probability, which was significantly higher than that in the US series ( $z = 2.07, p < .05$ ). For the US textbook series, the second highest percentage of problem-posing tasks was related to algebra, which was significantly higher than that in BNU series ( $z = 3.64, p < .001$ ). Very few PP tasks were related to geometry and measurement.

Content Area	Chinese (n=131)	US (n=60)
Numbers and Operations	61.07	78.33
Algebra	3.05	18.33
Geometry	2.29	0
Measurement	2.29	0
Data analysis and probability	12.98	3.33
Undetermined	18.32	0

Table 2: Percentages of PP tasks in content areas

### Types of Problem-Posing Tasks

Five types of PP tasks were identified. Each of these types of PP tasks along with an example is given below.

**Type I** (Reformulation of a given problem). Students are asked to pose a similar problem based on a given problem. For example: *If 6 people share 3 apples, each person will get 1/2 of an apple. Make up a problem about equal shares so that each person gets one fourth of something* (TERC, 2008c, Unit 7, p. 35).

**Type II** (Posing additional problems). Students are asked to pose additional problems for a given problem. One example from Chinese textbook series is shown below (BNU, 2003, 3A, p. 43).

	<ol style="list-style-type: none"> <li>(1) If we want to buy 5 volleyballs, how much do we need to pay?</li> <li>(2) If we bought three footballs, and paid the cashier 100 dollars, how much can we get for change?</li> <li>(3) If I want to buy one badminton racket and 10 badminton shuttlecocks, how much do I need to pay?</li> <li>(4) Please pose two more questions and answer them.</li> </ol>
--	---

Figure 1

**Type III** (Posing problems with given operations). Students are asked to make up a word problem that can be solved with a given operation. For example: *Write a story problem for  $65 \times 35$ . Then solve the problem and show how you solved it* (TERC, 2008d, Unit 8, p. 29).

**Type IV** (Posing a problem through supplementing information and questions). In order to pose a problem, supplementing information and questions are needed. For example, *Four children (A, B, C, and D) are practicing Chinese typing. In the following table is their practice time every day and their records on a test where each of them could select an article to type. Based on the data source, please pose two questions and try to answer them* (BNU, 2014, 4A, p. 72).

		A	B	C	D
Practice time every day (in minutes)		20	30	35	60
Test records	Time (Minutes)	12	19	18	13
	No. of words typed	384	931	846	728

Figure 2

**Type V** (Describe a situation to match a given mathematical representation). For example, *Write a story to match the graph shown below* (TERC, 2008C, Unit 6, p.19).

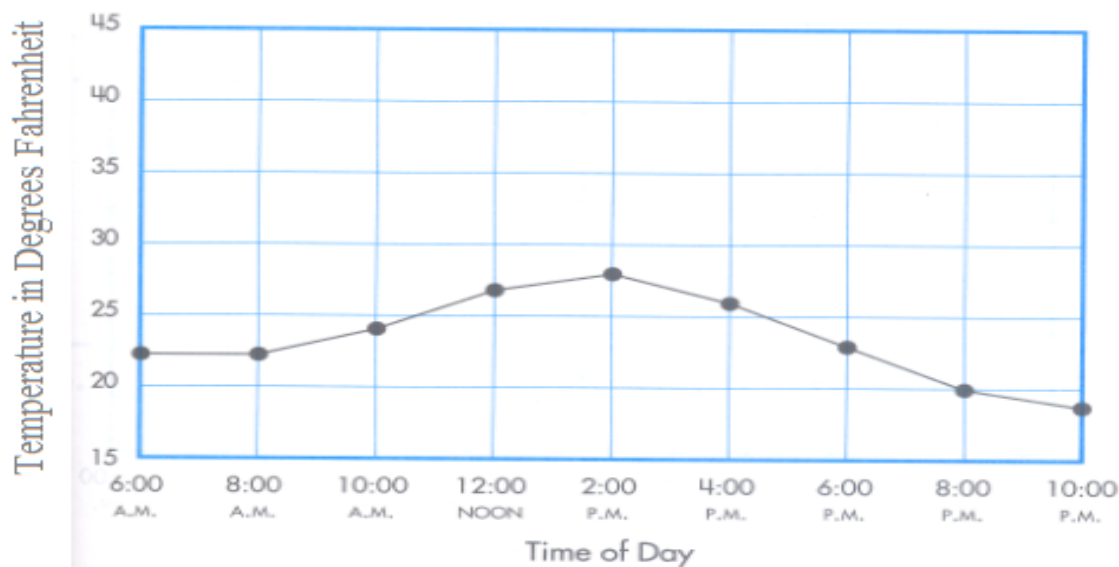

Figure 3

Table 3 shows the percentages of the five types of PP tasks in both textbook series. Overall, the percentage distribution of the five types of PP tasks was significantly different between the two textbook series ( $\chi^2(4, N=191) = 131.50, p < .001$ ). The majority of PP tasks in the Chinese textbook series were type II tasks, which was significantly higher than that in the U.S. textbook series ( $z = 7.12, p < .001$ ). However, for the U.S. textbook series, the majority of PP tasks were type III tasks, which was significantly higher than in the Chinese textbook series ( $z = 10.21, p < .001$ ). For the Chinese textbook series, the second and the third highest percentages of PP tasks were

type I and IV tasks, which were also significantly higher than in the U.S. textbook series (Type I:  $z = 2.03, p < .05$ ; Type IV:  $z = 3.11, p < .002$ ). However, in the U.S. textbook series, there was a much higher percentage of type V PP tasks than in the Chinese textbook series ( $z = 3.40, p < .001$ ).

PP Types	I	II	III	IV	V
China (n=131)	24.43	55.76	3.82	14.50	1.53
US (n=60)	11.67	1.67	73.33	0	13.33

Table 3: Percentage of Each Type of Problem-posing Tasks

### Inclusion of PGT Representations and Sample Problems

We also analyzed the PP tasks to examine if there was the inclusion of pictorial, graphical, or tabulated (PGT) representations in the PP tasks and whether sample questions were included for students in the PP tasks. Nearly 80% of the PP tasks in the Chinese textbook series included pictorial, graphical, or tabulated (PGT) representations, but only 20% of the PP tasks in the U.S. series included PGT representations. This result is somewhat surprising as Chinese students are less likely to use PGT representations than U.S. students in problem solving (Cai, 1995).

With respect to whether sample questions were included for students in the PP tasks, in 57% of the PP tasks from the Chinese textbook series, a sample question was given. However, a sample question was given in only 15% of the PP tasks in the U.S. series.

### CONCLUSIONS

Curriculum reform has often been viewed as a powerful tool for educational improvement because changes in curriculum have the potential to change classroom instruction and student learning (Cai & Howson, 2013). There is a lack of research examining problem-posing in the mathematics curriculum. The research presented here sheds new light on the inclusion of problem posing in the mathematics curriculum. By analyzing problem posing in textbooks, we gain insight into how reform ideas are reflected in the mathematics curriculum. With respect to problem posing itself, it would appear that curriculum reform has moved problem-posing tasks into greater prominence, but great effort is needed to make PP a reality in both curriculum and instruction. In fact, our analysis shows that even in the so-called reform textbooks, the proportion of PP tasks is very small. In order to truly make problem posing prominent in classroom instruction, curriculum developers and textbook writers must increase the coverage of PP tasks in textbooks so that teachers can draw from the resource and teach students problem posing. Only then can students have rich opportunities to learn mathematics through problem posing.



## References

- Beijing Normal University Press, Office of Mathematics Curriculum Standards for Compulsory Education. (2001-2006). *Shuxue* [in Chinese]. Beijing: Beijing Normal University Press.
- Brink, J. F. van den (1987). Children as arithmetic book authors. *For the Learning of Mathematics*, 7, 44-48.
- Cai, J. (1995). A cognitive analysis of U.S. and Chinese students' mathematical performance on tasks involving computation, simple problem solving, and complex problem solving. *Journal for Research in Mathematics Education Monograph Series*, 7.
- Cai, J., & Hwang, S. (2002). Generalized and generative thinking in U.S. and Chinese students' mathematical problem solving and problem posing. *Journal of Mathematical Behavior*, 21(4), 401-421.
- Cai, J., & Howson, A. G. (2013). Toward an international mathematics curriculum. In M. A. Clements, A. Bishop, C. Keitel, J. Kilpatrick, & K. S. F. Leung (Eds.), *Third international handbook of mathematics education research*. New York: Springer.
- Chinese Ministry of Education, Office of School Teaching Materials and Institute of Curriculum and Teaching Materials. (1986). *A collection of mathematical syllabuses (1949-1985)*. Beijing, China: Author.
- Chinese Ministry of Education. (2001). 全日制义务教育数学课程标准（实验稿）. 北京：北京师范大学出版社 [Curriculum standards for school mathematics of nine-year compulsory education (trial version)] [in Chinese]. Beijing: Beijing Normal University Press.
- Chinese Ministry of Education. (2003). 普通高中数学课程标准（实验）·北京：人民教育出版社 [Curriculum standards of high school mathematics (trial version)] [in Chinese]. Beijing: People's Education Press.
- Doyle, W. (1983). Academic work. *Review of Educational Research*, 53, 159-199.
- Hashimoto, Y. (1987). Classroom practice of problem solving in Japanese elementary schools. In J. P. Becker & T. Miwa (Eds.), *Proceedings of the U.S.-Japan seminar on mathematical problem solving* (pp. 94-119). Carbondale, IL: Southern Illinois University.
- Healy, C. C. (1993). *Creating miracles: A story of student discovery*. Berkeley, CA: Key Curriculum Press.
- Keil, G. E. (1967). Writing and solving original problems as a means of improving verbal arithmetic problem solving ability. *Dissertation Abstracts International*, 25(12), 7109.
- National Council of Teachers of Mathematics. (1989). *Curriculum and evaluation standards for school mathematics*. Reston, VA: Author.
- National Council of Teachers of Mathematics. (1991). *Professional standards for school mathematics*. Reston, VA: Author.
- National Council of Teachers of Mathematics. (2000). *Principles and standards for school mathematics*. Reston, VA: Author.

- Polya, G. (1957). *How to solve it* (2<sup>nd</sup> ed.). Princeton, NJ: Princeton University Press.
- Singer, F. M., Ellerton, N., & Cai, J. (2013). Problem-posing research in mathematics education: New questions and directions. *Educational Studies in Mathematics*, 83(1), 1-7.
- Silver, E. A. (1994). On mathematical problem posing. *For the Learning of Mathematics*, 14(1), 19-28.
- TERC. (2008). *Investigations in number, data, and space: Grades 1-5 student activity book (Units 1-9)*. Glenview, IL: Pearson Education, Inc.

# THE FREQUENCIES OF VARIOUS INTERPRETATIONS OF THE DEFINITE INTEGRAL IN A GENERAL STUDENT POPULATION

Steven R. Jones

Brigham Young University

*Student understanding of integration has become a topic of recent interest in calculus research. Studies have shown that certain interpretations of the definite integral, such as the area under a curve or the values of an anti-derivative, are less productive in making sense of contextualized integrals, while on the other hand understanding the integral as a Riemann sum or as “adding up pieces” is highly productive for contextualized integrals. This report investigates the frequency of these three conceptualizations in a general calculus student population. Data from student responses show a high prevalence of area and anti-derivative ideas and a very low occurrence of summation ideas. This distribution held even for students whose calculus instructors focused on Riemann sums while introducing the definite integral.*

## INTRODUCTION

First-year calculus has received much attention in mathematics education in recent years due to its significance in science, technology, engineering, and mathematics (STEM) fields. In particular, the calculus concept of the definite integral has become a current topic of interest among mathematics education researchers (e.g. Black & Wittmann, 2007; Hall, 2010; Jones, 2013; Sealey & Oehrtman, 2007; Thompson & Silverman, 2008). The integral is an important topic to investigate because it is commonly used in subsequent mathematics courses (see Brown & Churchill, 2008; Fitzpatrick, 2006) and provides the foundation for many concepts in science and engineering coursework (see Hibbeler, 2012; Serway & Jewett, 2008).

However, several studies demonstrate that students are struggling to apply their knowledge of integration to subsequent courses (e.g. Beichner, 1994; Christensen & Thompson, 2010; Grundmeier, Hansen, & Sousa, 2006; Pollock, Thompson, & Mountcastle, 2007). This finding has led some researchers to begin to examine *why* students are having this difficulty. Sealey (2006) and Jones (2013) suggest that the “area under a curve” notion alone is not sufficient for understanding definite integrals. Thompson and Silverman (2008) promote the development of an “accumulation” conception of the integral in order to help students.

Jones (under review) subsequently conducted a more thorough analysis of the anti-derivative, area under a curve, and summation interpretations of the definite integral by students in both mathematics and science contexts. The results demonstrate that the “summation” conception proved highly productive for understanding definite integrals that are either situated in a larger context or that contain variables representing physical quantities. By contrast, the study confirms that the “area under a

curve” and “values of an anti-derivative” conceptions are less productive in making sense of these types of contextualized definite integrals. While the findings do *not* imply that the area and anti-derivative ideas are not important (nor that they should not be learned) they *do* suggest that it is critical for students to have a robust and accessible summation conception of integration in their cognitive repertoire.

Based on these results, it is important to ask the question: Are calculus students generally constructing their knowledge of the integral in a way that promotes the beneficial summation conception? This paper seeks to answer this question by investigating (a) how common each of the three conceptualizations are when a large sample of calculus students are asked to think about integration, and (b) whether standard ways of introducing Riemann sums are sufficient for a general student population to internalize the summation conception.

## THEORETICAL PERSPECTIVE

### Symbolic forms

For this study, the manner in which students hold their knowledge of the integral is characterized through the lens of *symbolic forms* (Sherin, 2001). A symbolic form is a blend (Fauconnier & Turner, 2002) between a *symbol template* and a *conceptual schema*. The symbol template refers to the arrangement of the symbols in an equation or expression, such as  $\int_{\square}^{\square} \square d[\square]$ , where each “box” can be filled in with symbols. The conceptual schema is the meaning that underlies the symbols in the template. Jones (2013) documents students’ symbolic forms of the definite integral that are associated with the notions of area under a curve, values of an anti-derivative, and summations. Note that the students in the study regularly ascribed “anti-derivative” meanings to both indefinite *and* definite integrals. Furthermore, Jones describes a “deviant” of the typical Riemann sum conception that was dominant in some students’ thinking. These four symbolic forms aided the analysis of the student data by helping determine when students were drawing on each the area, anti-derivative, or summation conceptualizations of the integral. A brief description of each form is provided here.

*Area and perimeter:* This symbolic form interprets each “box” in the symbol template as being one part of the perimeter of a shape in the (*x-y*) plane. The differential, “*d*[],” represents the “bottom” of the shape by dictating the variable that resides on the horizontal axis. This symbolic form is associated with the “area under a curve” notion.

*Function matching:* This symbolic form interprets the integrand as having come from some “original function.” The original function became the integrand through a derivative, and the differential “*d*[]” indicates the variable with respect to which the derivative was taken. This form is associated with the “anti-derivative” conception.

*Adding up pieces:* This form casts the differential as being a tiny piece of the domain, given by the limits of integration. Within each tiny piece, the quantities represented by the integrand and differential are multiplied to create a small amount of the resultant

quantity. The integral symbol dictates an “infinite” summation that ranges over the domain. This form is related to the Riemann sum idea.

*Adding up the integrand:* This is a “deviant” of the *adding up pieces* form. The key difference is that within each tiny piece, only the quantity represented by the *integrand* is added up. This resulting “total” from the integrand is then multiplied by the entire domain (length, area, or volume) to get the resulting quantity. This form fails to adequately describe the Riemann sum process, but is rooted in ideas of summations.

### **Manifold view of knowledge**

Symbolic forms can be considered a subset of “cognitive resources” (Hammer, 2000), which are any piece of cognition that can be drawn on and employed as a unit, whether large or small. The main idea from cognitive resources that is used for this paper is the push away from a “unitary view” of concepts to a “manifold view” of knowledge (Hammer, Elby, Scherr, & Redish, 2005). The theory of resources argues that a “concept” such as the integral is comprised of many small and large elements—like rectangles, graphs, functions, ideas about summation, areas, limits, anti-derivative rules, and so forth—that are too complex to be considered a single entity.

Thus, this study assumes that students can think about the integral by drawing on certain aspects of their “integral knowledge” while other aspects remain dormant. For example, a student may look at an integral and immediately think “area under a curve” without ever thinking about Riemann sums. This does not necessarily mean that the student does not have a Riemann sum conception in their cognition, but rather that the area conception is much more familiar and readily accessible to them. This has implications for learning integrals, since students need not only to “assimilate” a summation conception somewhere in their cognition, but that that conception needs to be created in a way that it is prevalent in their thinking to capitalize on its usefulness.

## **METHODS**

### **Initial survey**

In order to investigate the prevalence of the area, anti-derivative, and summation conceptions of the definite integral, 150 students at two major colleges in the Western United States, who had successfully completed first-semester calculus, were recruited to participate in a survey that asked them open-ended questions about definite integrals. A  $\chi^2$ -test revealed no significant difference between the students at these two schools, in terms of the frequencies of the responses that were coded as belonging to the each conception of the integral used in this study (see below for more detail). This allows for the assumption that these students may be considered representative of the general calculus student population. The choice to use successful first-semester students is based on the fact that many key aspects of the integral are explored during the first semester: areas under curves, the Riemann integral definition, the Fundamental Theorem of Calculus (FTC), the Net Change Theorem, velocity/position applications, and anti-derivative techniques (including  $u$ -substitution).

To recruit students, several second-semester calculus courses were visited within the first two days of the semester in order to administer the survey. Students who had already taken second semester calculus (or the equivalent in high school) were asked not to complete the survey, to keep the focus of the study on students who had only successfully finished first-semester calculus. The students who participated were given fifteen minutes to complete the survey.

Two of the four items from the survey form the focus for this paper. The first item reads, “Explain in detail what  $\int_a^b f(x)dx$  means. If you think of more than one way to describe it, please describe it in multiple ways. Please use words, or draw pictures, or write formulas, or anything else you want to explain what it means.” The item clearly asks the students to express any and all ways that they conceive of the integral and this instruction was reiterated to the students when the surveys were administered. The second item reads, “Why does an integral need a ‘ $dx$ ’ on it? For example, why can’t it just be  $\int_0^1 x^3$  instead of  $\int_0^1 x^3 dx$ ? Explain in as much detail as you can.” The main purpose of this question was to give the students a second context to discuss their ideas about integrals as well as to ask them to mentally break apart the integral symbol template, in order to discuss the integral in more detail. The way in which they explained the existence of “ $dx$ ” was also compared to the symbolic forms of the integral described in the previous section, to see if the students were possibly invoking other conceptualization beyond what they used for their responses to item 1.

Responses to the items were coded into the “area,” “anti-derivative,” “summation,” or “weak summation” categories. Many responses were coded into multiple categories if the students expressed more than one idea in their answer. Responses were coded based either on (a) an explicit statement regarding one of the three main conceptualizations, or (b) the inferences made by the correlation of a response to one of the symbolic forms of the integral. The “weak summation” category was included since several responses hinted at a summation notion, but were not articulated enough to be conclusive. Also, responses along the lines of the *adding up the integrand* symbolic form were placed in “weak summation.” Confidence intervals (95%-level) were used to estimate the percentages of the overall calculus student population that might respond similarly to these survey items (see Triola, 2010).

### **Classroom observations and second survey**

In order to investigate whether standard classroom instruction can adequately support the creation of a robust summation conception, two veteran instructors of first-semester calculus from one of the schools were recruited for observation. Both instructors taught large sections (200+ students) and the first five of their one-hour lessons on integration were observed and videotaped. Both instructors had taught calculus many times and used standard templates for their lesson schedule. A sample of students from their courses were surveyed ( $n = 55$ ), using a “cluster sample” technique on the individual lab sections. This occurred during the same semester as the

previous survey, ensuring that there was no overlap between the two samples. A  $\chi^2$ -test was conducted for both survey items ( $\alpha = .05$ ) to compare the frequencies of responses of these instructors' students to the responses of the general sample (see Triola, 2010).

## RESULTS

### General population sample

Table 1 illustrates the frequency of responses that fit under each conceptualization of the integral for items 1 and 2. Note that since many students provided elaborated answers that fit into more than one category, the frequencies add up to more than the sample size. Confidence intervals (95%-level) have been included as estimates for the percentage of the overall calculus student population that might respond similarly.

Conceptualization	Responses from item 1	Reponses from item 2
Area	131 (82.0% < $p$ < 92.7%)	7 (1.3% < $p$ < 8.0%)
Anti-derivative	60 (32.2% < $p$ < 47.8%)	114 (69.2% < $p$ < 82.8%)
Summation	10 (2.7% < $p$ < 10.7%)	11 (3.2% < $p$ < 11.5%)
Weak summation	7 (1.3% < $p$ < 8.0%)	2 ( <i>n/a, low frequency</i> )

Table 1: Frequencies of responses ( $n = 150$ ), with confidence intervals

The data show a high prevalence of area and anti-derivative conceptions when students think about the integral. This in and of itself is not bad, since these two notions are helpful, useful ideas. However, what is surprising is the low frequency of students who invoked any type of summation conception. Even taking “summation” and “weak summation” together, only 17 out of 150 students ( $6.3\% < p < 16.4\%$ ) made *any* kind of statement dealing with summations on item 1. Further, 117 out of 150 students ( $71.4\% < p < 84.6\%$ ) made *no* mention of anything related to summations whatsoever on either item 1 or item 2. With confidence, I can assert that roughly three-fourths of *successful* first-semester calculus students leave their first-semester course without a familiar, accessible conception of the Riemann sum or any related “adding up pieces” idea. This, of course, is not to say that these students have *no* summation conception in their cognition; they may express something along these lines if pressed. Yet, given the important nature of the summation conception (Jones, under review), it is striking that so few students “choose” to activate that knowledge when asked to explain what a definite integral is or what it means. This has important ramifications for understanding integrals in further coursework where a Riemann sum conception is critical for making sense of a contextualized integral expression or equation.

### Observed instructors and their students

Both observed instructors used Riemann sums to introduce integration, as a way to approximate the area underneath the graph of a function. They drew the familiar rectangles under the curve and walked through examples of calculating left-hand, right-hand, and midpoint approximations. Both instructors regularly discussed Riemann sums throughout the first two one-hour class sessions. During the third lesson

both instructors moved to the Fundamental Theorem of Calculus and then, for the remainder of the observed lessons, the instructors focused on calculating anti-derivatives and discussing a variety of integral properties. In short, their instruction reflected how many textbooks present integration (e.g. Stewart, 2012; Thomas, Weir, & Hass, 2009). These observations show that Riemann sums were a significant portion of the early instruction regarding integration.

Based on these observations, one might hope that these students showed a stronger tendency to interpret integrals through a summation interpretation, in addition to the area and anti-derivative conceptualizations. Unfortunately, however, in essentially every way these students reflected the general population sample. Table 2 shows the breakdown of responses from these instructors' students ( $n = 55$ ), including  $p$ -values from the  $\chi^2$ -tests ( $\alpha = .05$ ) that were done on the frequencies of responses from these students versus the frequencies of responses from the general population sample.

Conceptualization	Responses from item 1	Responses from item 2
Area	47	1
Anti-derivative	14	38
Summation	8	9
Weak summation	4	3
( $\chi^2$ -test)	$p = .13$	$p = .07$

Table 2: Frequencies of responses ( $n = 55$ ) and  $p$ -values from  $\chi^2$ -tests

Neither  $p$ -value was below the threshold for statistical significance. The  $p$ -value for item 2 was close to the “.05” mark, but since neither test was significant, the results suggest that there is no important difference between these instructors' students and the overall population described previously. This outcome leaves us with the conclusion that the attention the instructors gave to the Riemann sum throughout their first two lessons did not make an impact in supporting the students' creation of a robust summation conception. Therefore, merely having Riemann sums present during instruction is *not* sufficient for accomplishing this goal. More, apparently, is needed.

## DISCUSSION AND FUTURE DIRECTIONS

The results of this study suggest that simply giving attention to Riemann sums is *not* enough to help students construct a viable summation conception in regards to integration. By examining the manner in which these two instructors introduce integration, we see a common theme that may contribute to this issue.

Both instructors began their introductory lesson on integration by using the “area under the graph of a function” as the primary motivation for the study of integrals. Riemann sums were invoked only as a way to calculate the irregular shapes created by the graphs, since basic geometry could not be used. For example, one instructor began the lesson by saying, “We’re going to draw a graph... And I want to find the area under this [graph], between the  $x$ -axis and this [graph].” The instructor then created



rectangles underneath the graph to approximate the area. Similarly, the second instructor introduced integration by saying that areas under curves was the second “main idea” of calculus. “Second is integrals. Integrals can be thought of as area under a curve.” He then drew a generic graph, with vertical lines at  $x = a$  and  $x = b$ , and shaded in the area of the shape created by the graph and the vertical lines. “This area between the curve and the  $x$ -axis, that’s represented by the idea of an integral.” This instructor then also used Riemann sums to approximate these irregularly shaped areas.

It appears from these lessons that, even though Riemann sums are used, the central concept portrayed to the students is still that of “area under a curve.” In fact, Riemann sums are used only as a “tool” for getting at these areas. By doing this, instructors may inadvertently be reducing Riemann sums to a procedure for calculating areas under curves—the more salient goal of the lesson. The summation conception does not have the chance to stand on its own as an important idea. Thus, when students encounter the FTC, they might decide that anti-derivatives are a better/easier “tool” for calculating areas, and the Riemann sum conception takes a cognitive “backseat” to the anti-derivative notion. This may, in part, explain the students’ prevalent use of areas and anti-derivatives to explain integrals, while rarely appealing to summations.

In order to investigate this problem further, the author is currently involved in a design experiment that seeks to examine other ways of introducing the integral, in order to highlight the summation conception as the *basis* of the integral. This is done through several activities, based off those described in Jones (2013/14), that use Riemann sums *without* discussing areas under curves. For example, the accumulation of water spilled from a pipe can be estimated, using Riemann sums, from discrete data points. Or the mass of an object with non-uniform density can be estimated by selecting density data points and multiplying them to each small piece of volume. Preliminary results of the study are showing promising outcomes for conveying to students that the Riemann sum is the central, underlying conception (and definition) of definite integrals.

## References

- Beichner, R. J. (1994). Testing student interpretation of kinematics graphs. *American Journal of Physics*, 62(8), 750-762.
- Black, K. E., & Wittmann, M. C. (2007). Epistemic games in integration: Modeling resource choice. *AIP Conference Proceedings*, 951, 53-56.
- Brown, J., & Churchill, R. (2008). *Complex variables and applications* (8<sup>th</sup> ed.). New York: McGraw-Hill.
- Christensen, W. M., & Thompson, J. R. (2010). Investigating student understanding of physics concepts and the underlying calculus concepts in thermodynamics. *Proc. 13<sup>th</sup> special interest group of the Mathematical Association of America on research in undergraduate mathematics education*, Raleigh, NC. Retrieved from <http://sigmaa.maa.org/rume/crume2010/Archive/Thompson%20&%20Christensen.pdf>
- Fauconnier, G., & Turner, M. (2002). *The way we think: Conceptual blending and the mind's hidden complexities*. New York: Basic Books.

- Fitzpatrick, P. M. (2006). *Advanced calculus* (2<sup>nd</sup> ed.). Providence, RI: AMS.
- Grundmeier, T. A., Hansen, J., & Sousa, E. (2006). An exploration of definition and procedural fluency in integral calculus. *PRIMUS: Problems, Resources, and Issues in Mathematics Undergraduate Studies*, 16(2), 178-191.
- Hall, W. L. (2010). Student misconceptions of the language of calculus: Definite and indefinite integrals. *Proc. 13<sup>th</sup> special interest group of the Mathematical Association of America on research in undergraduate mathematics education*, Raleigh, NC. Retrieved from <http://sigmaa.maa.org/rume/crume2010/Archive/Hall.pdf>
- Hammer, D. (2000). Student resources for learning introductory physics. *American Journal of Physics*, 68(S1), S52-S59.
- Hammer, D., Elby, A., Scherr, R. E., & Redish, E. F. (2005). Resources, framing, and transfer. In J. Mestre (Ed.), *Transfer of learning from a modern multidisciplinary perspective* (pp. 89-120). Greenwich, CT: Information Age Publishing.
- Hibbeler, R. C. (2012). *Engineering mechanics: Statics* (13<sup>th</sup> ed.). Upper Saddle River, NJ: Pearson Prentice Hall.
- Jones, S. R. (2013). Understanding the integral: Students' symbolic forms. *The Journal of Mathematical Behavior*, 32(2), 122-141.
- Jones, S. R. (2013/14). Adding it all up: Reconciling the introduction to the integral. *Mathematics Teacher*, 107(5), 372-377.
- Pollock, E. B., Thompson, J. R., & Mountcastle, D. B. (2007). Student understanding of the physics and mathematics of process variables in PV diagrams. *AIP Conference Proceedings*, 951, 168-171.
- Sealey, V. (2006). Definite integrals, Riemann sums, and area under a curve: What is necessary and sufficient? In S. Alatorre, J. L. Cortina, M. Sáiz, & A Méndez (Eds.), *Proc. 28<sup>th</sup> annual meeting of the North American chapter of the Int. Group for the Psychology of Mathematics Education* (Vol. 2, pp. 46-53). Merida, Mexico: PMENA.
- Sealey, V., & Oehrtman, M. (2007). Calculus students' assimilation of the Riemann integral into a previously established limit structure. In T. Lamberg & L. Wiest (Eds.), *Proc. 29<sup>th</sup> annual meeting of the North American chapter of the Int. Group for the Psychology of Mathematics Education* (pp. 78-84). Stateline, NV: PMENA.
- Serway, R. A., & Jewett, J. W. (2008). *Physics for scientists and engineers* (7<sup>th</sup> ed.). Belmont, CA: Thomson Learning.
- Sherin, B. L. (2001). How students understand physics equations. *Cognition and Instruction*, 19(4), 479-541.
- Stewart, J. (2012). *Calculus: Early transcendentals* (7<sup>th</sup> ed.). Belmont, CA: Brooks/Cole.
- Thomas, G. B., Weir, M. D., & Hass, J. (2009). *Thomas' calculus* (12<sup>th</sup> ed.). Boston, MA: Pearson.
- Thompson, P. W., & Silverman, J. (2008). The concept of accumulation in calculus. In M. Carlson & C. Rasmussen (Eds.), *Making the connection: Research and teaching in undergraduate mathematics* (pp. 117-131). Washington, DC: MAA.
- Triola, M. F. (2010). *Elementary statistics* (11<sup>th</sup> ed.). Boston, MA: Addison-Wesley.

# YOUNG CHILDREN'S THINKING ABOUT VARIOUS TYPES OF TRIANGLES IN A DYNAMIC GEOMETRY ENVIRONMENT

Harpreet Kaur, Nathalie Sinclair

Simon Fraser University

*This paper presents preliminary results of longitudinal study on the development of children's geometric thinking in dynamic geometry environments. Here we investigate young children's (age 7-8, grade 2/3) interactions, in a whole classroom setting with an Interactive Whiteboard, with Sketchpad-based tasks involving the use of different types of constructed triangles (scalene, isosceles, equilateral). We use Sfard's discursive approach to show how the children developed a reified discourse on these different types of triangles and how they described the behaviour of these triangles in terms of their invariances (side lengths and angles).*

## INTRODUCTION

In this paper, we report on an exploratory study conducted with a split class of grade 2/3 children (ages 7-8) working with various types of triangle sketches using *The Geometer's Sketchpad*. The focus of this research is to study how the use of *Sketchpad* affects the children's thinking about triangles, including how they attend to various aspects of the dynamic sketches, how they talk and gesture about the moving objects on the screen, and how they reason about the behaviour of different types of triangles (i.e. scalene, isosceles and equilateral triangle).

## CHILDREN'S UNDERSTANDING OF CLASSIFICATION OF SHAPES

Research shows that children have difficulty working with definition when classifying and identifying shapes (Gal & Linchevski, 2010). de Villiers (1994) suggests that classifying is closely related to defining (and vice versa) and classifications can be hierarchical (by using inclusive definitions, such as a trapezium or trapezoid is a quadrilateral with at least one pair of sides parallel – which means that a parallelogram is a special form of trapezium) or partitional (by using exclusive definitions, such as a trapezium is a quadrilateral with only one pair of sides parallel, which excludes parallelograms from being classified as a special form of trapezium). In general, in mathematics, inclusive definitions are preferred. A number of studies have reported on students' problems with the hierarchical classification of quadrilaterals (Fuys, Geddes & Tischer, 1988; Clements & Battista, 1992; Jones, 2000). However, Battista (2008) designed the *Sketchpad*-based *Shape Makers* microworld that provides grade 5 students with screen manipulable shape-making objects. For instance, the Parallelogram Maker can be used to make any desired parallelogram that fits on the screen, no matter what its shape, size or orientation—but only parallelograms. This motivated our research on children's identifying and classifying of different types of triangles.

## THEORETICAL PERSPECTIVE

In previous research, we have found Sfard's (2008) 'commognition' approach is suitable for analysing the geometric learning of students interacting with DGEs (dynamic geometry environments) (see Sinclair & Moss, 2012). For Sfard, thinking is a type of discursive activity. Sfard's approach is based on a participationist vision of learning, in which learning mathematics involves initiation into the well-defined discourse of the mathematical community. The mathematical discourse has four characteristic features: word use (vocabulary), visual mediators (the visual means with which the communication is mediated), routines (the *meta-discursive rules* that navigate the flow of communication) and narratives (any text that can be accepted as true such as axioms, definitions and theorems in mathematics). Learning geometry can thus be defined as the process through which a learner changes her ways of communicating through these four characteristic features. In the context of identifying shapes, Sfard has proposed the following three levels of discourse characterised by different types of routines and word uses, which Sinclair & Moss (2012) use in their study of children's interactions with DG triangles:

- 1<sup>st</sup> level: the word 'triangle' is used as a proper noun. The routine of identification involves visual object recognition.
- 2<sup>nd</sup> level: the word 'triangle' is used as a family name, that is, the name of a category of elementary objects; identification is made according to visual family recognition as well as through an informal properties check.
- 3<sup>rd</sup> level: the word 'triangle' is used as the name of a category of objects, and identification is made through visual family resemblance first, and then verification/refinement of properties.

At the 3<sup>rd</sup> level, since the condition specified by one definition (i.e. of equilateral) may be an extension of the condition in another (i.e. of isosceles triangle), children can make use of inclusive definitions (term suggested by de Villiers, 1994). We are particularly interested in investigating how the children might move between different word uses, routines, narratives and progress to higher levels of discourse.

## METHOD OF RESEARCH

### Participants and data collection

This teaching experiment is part of a larger project that involves the study of children's geometric thinking in the primary grades. We worked with grade 2/3 split classroom children from a pre-K-6 school in an urban middle SES district. There were 24 children in the class from diverse ethnic backgrounds and with a wide range of academic abilities. We worked with the children on a bi-weekly basis on a variety of geometric concepts for seven months. Three lessons were conducted on the topic of triangles. Each lesson lasted approximately 60 minutes and was conducted with the children seated on a carpet in front of an interactive whiteboard. Two researchers, and the classroom teacher, were present for each lesson. One researcher (second author) took

the role of the teacher for these interventions. Lessons were videotaped and transcribed. This paper is focused on the first and second of the three lessons. Previous lessons involved *the concepts of* symmetry and angles, but they had never received formal instruction about classification of triangles before.

### Dynamic triangle sketches

Along the lines of work of Battista (2008), we developed the Triangle ShapeMakers sketches (see Figure 1) for different types of triangles (scalene, isosceles, equilateral triangles, right triangle). Each triangle type had a different colour (pink for scalene, red for equilateral, blue for isosceles and green for right).

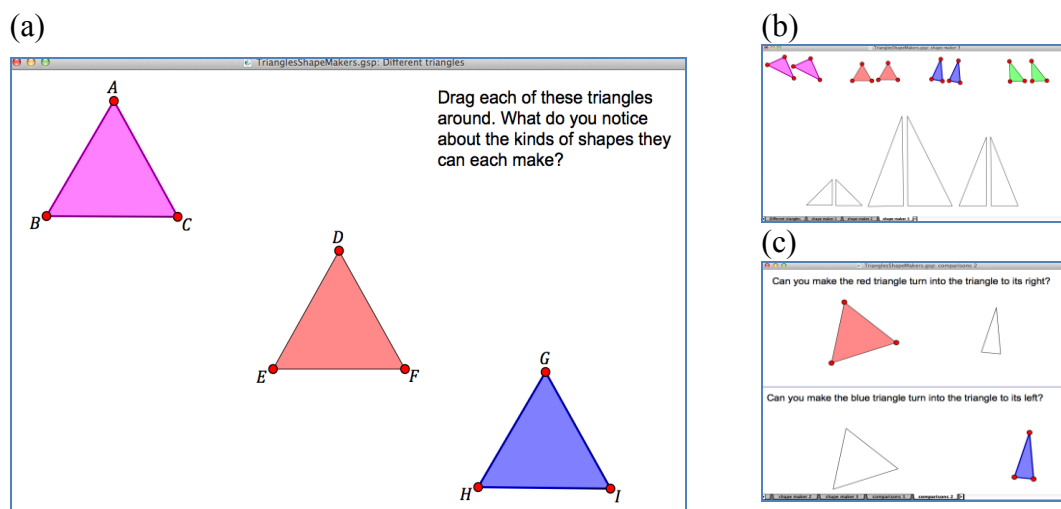

Figure 1(a, b, c): Three different Triangle ShapeMaker sketches

In the sketch shown in figure 1(a) all look like equilateral triangles, but only the middle one is constructed to be so; the bottom right one is an isosceles triangle and the top left is scalene. Students were asked to explore the similarities and differences between the three triangles. For the sketch in figure 1(b), the students were asked to explore which coloured triangles could fit in the given triangle outlines. Note that the equilateral triangles cannot be used, and only the right triangles will fit into the two left-most outlines. The sketch in figure 1(c) focused on exploring whether an equilateral triangle can fit into the given isosceles triangle (top) and whether an isosceles triangle can fit into a given equilateral triangle (bottom).

### Behaviour of dynamic scalene, isosceles and equilateral triangles

Although no vertex was labelled in the sketches, we have done so in Figure 1a in order to explain the dragging behaviour of different triangles. In the scalene (pink) triangle, dragging any one vertex (A, B or C) does not move the other two vertices, whereas in equilateral (red) triangle, dragging vertex E or F (which determine the size of the triangle) moves the entire triangle except the vertex F or E respectively; dragging vertex D simply translates the triangle from one place to another. In the isosceles (blue) triangle, dragging vertex (I) does not move the other two vertices, dragging vertex H or G moves the entire triangle except the vertex G or H respectively.

## EXPLORING STUDENTS' LEARNING ABOUT TYPES OF TRIANGLES

To begin, the teacher (second author) appointed three children to drag each of the coloured triangles in the sketch (figure 1a). The children seated on the floor were asked to be “detectives” and to “describe what kinds of triangles can be made”, “what can change and what stays the same” in each of the triangles.

### Comparing the dragging of scalene and equilateral triangle

The first child Neva dragged the pink (scalene) triangle into various sizes and orientations i.e. skinny and long, small and big triangles. Then Adil dragged the red (equilateral) triangle and the teacher asked if he could make it long and skinny. Observing the dragging patterns, some students said no. The teacher asked the students that why is it not possible to make the red triangle long and skinny.

Egan: Because the red one, it's different than that (*pointing to the pink triangle*) and I think it can only go by a perfect triangle.

The teacher asked what Egan meant by “perfect triangle”, to which Rabia responded:

Rabia: Because the other triangle (*pointing to the pink triangle*) can move at a point but this one (red triangle) can move bigger or smaller differently.

Another student described the behaviour of a perfect triangle as below:

Jace: Everything moves with it except one point.

Teacher: (*Dragging the equilateral triangle*). Even when it is getting bigger and smaller, is there anything that stays the same as I make it bigger and smaller? (Many children put their hands up) Neva?

Neva: The angles.

The children started to notice the changes in the red triangle as Adil dragged one of the vertices. Egan's statement “it's different than that” shows that he started to notice the differences between the red and pink triangles, even though they initially looked the same in their static configurations. Egan's response ‘only go by a perfect triangle’ is based on his visual recognition of similarity to previously seen prototypical triangles, thus using a first level of discourse. Further, in Rabia's description “other triangle can move at a point” and in Jace's statement “everything moves with it except one point”, the action words ‘move at a point’, ‘everything moves’ shows that the students are paying attention to the particular kinds of movement depicted by each triangle. The dragging tool initiated this kind of reasoning, so that the transforming triangles functioned as new visual mediators. Rabia's statement “move bigger or smaller differently” shows that she was noticing the different kind of size changing behaviour of the equilateral triangle as compared to the scalene triangle. The use of words ‘red one’, ‘it’, ‘the other triangle’, ‘this one’ to address the triangles show that the children are talking about one particular triangle as opposed to the family of those triangles. In addition, Neva noticed that ‘angles are staying’ the same under dragging. Thus, the children started to notice the informal properties (based on dragging behaviour) as well as formal properties (invariance of angles in red triangle) of the different triangles.

This shows that many of them are using a mixture of 1<sup>st</sup> and 2<sup>nd</sup> level discourse around types of triangles.

### Exploring the overlapping of one triangle over the other fixed triangle

After the students explored the dragging of different triangles, the teacher asked them if they could fit the blue (isosceles) triangle over the pink (scalene) triangle (without touching the pink triangle). Rabia first matched the two vertices of the blue triangle to one side of the pink triangle (fig 2a) and then tried to drag third vertex (shown by green dot in fig 2b) in upward direction and concluded that she couldn't fit the blue triangle onto the pink one.



Figure 2a, 2b, 2c: Snapshots of Rabia's overlapping attempt & Jory's gesture

Teacher: You think you can't? How come you can't?

Rabia: Because I think if I move that one (*placing marker at vertex <black dot> in fig 2b*), that one also moves (*placing marker at green dot in fig 2b*)

The teacher asked for other arguments, and called on Dale and then Jory:

Dale: Because the blue one can only move symmetrical.

Jory: So, this one (*placing right index finger at green dot (fig 2b)*) wherever you move it, then this one (*placing right index finger at black dot (fig 2b)*) moves with this (*placing left index finger at green dot (fig 2b)*), so when you move, it will go that way (*stretching his arms upwards along the two longer sides (figure 2c)*).

Rabia's statement "if I move that one, that one also moves" shows that she is paying attention to the causal type of movement relationship between the different parts of the triangle. While Dale's explanation "it can only move symmetrical," suggests that he has noticed invariance in the isosceles triangle, either holistically, or as a function of the movement of the congruent sides. The systematic dragging of the vertex of one of the longer sides of the isosceles (blue) triangle by Rabia acted as a visual mediator and seemed to help Dale see the property of symmetry. Jory's use of the words "wherever you move it, then this one moves with this" and "so when you move, it will go that way" along with the stretching arms gesture shows that he is also thinking about the simultaneous change in length of two arms of the isosceles triangle. The teacher labelled Dale's reasoning "a symmetry argument" and Jory's a "stretching argument". Most of the students agreed with these arguments by raising their hands or nodding their heads. Overall, the students came up with three arguments: (1) dragging vertex argument (dragging one point moves the other point) (2) symmetry argument (blue one can only move symmetrical) (3) Stretching side argument (with arm stretching gesture

where two arms act as two sides of triangle). These arguments show a 2<sup>nd</sup> level of discourse because they refer to informal/formal properties of the isosceles triangle.

Through teacher-led discussion, the students identified the properties of different sides staying the same or changing length in different triangles. After these invariances were stated explicitly, the teacher introduced the “special names” equilateral, isosceles and scalene for the red, blue and pink triangles, respectively.

In the second lesson, the children worked on the sketch in Figure 1(b). An attempt to fit the equilateral (red) triangle into the right-angled isosceles outline (figure 1b) was unsuccessful, whereas the scalene (pink) triangle fit in that outline without any difficulty. When asked why the equilateral triangle could not fit, Thom said:

Thom: It's because mostly that won't work because that one of them is seemed to be paralysed or something and doesn't want to move from its seat. But the pink one... the scalene ...can move anywhere it wants and the only one. I think it's the only one that can get inside the shape. I think it's only the green and pink that can make that shape, but the others are just paralysed.

Thom used the words ‘paralysed’, ‘doesn't want to move’ for equilateral and isosceles triangles, whereas for scalene triangle he used the words ‘can move anywhere’, ‘can get inside the shape’. Clearly, this vocabulary emerged after observing the free and restricted movements of different dynamic triangles and prompted him to make connections with real life experiences of the restrictive mobility of humans. Later, during the exploration of the third sketch (figure 1(c)), after the students had successfully placed an isosceles triangle into an equilateral outline, but not an equilateral triangle into an isosceles outline, the teacher asked:

Teacher: Why can we turn isosceles into equilateral, but we can't turn equilateral into the isosceles, Lida?

Lida: Isosceles can be turned into equilateral because two sides have to be the same, but that doesn't mean that all three sides can't be the same. At least two sides should be same.

In another overlapping task of scalene and equilateral triangle, the teacher asked

Teacher: How come scalene can make equilateral triangle?

Jory: Because scalene...um...they can create any shape of triangles.

Lida's statements “At least two sides should be same” and “that doesn't mean that all three sides can't be the same” give evidence of her use of inclusive definitions. Jory's statement “they can create any shape of triangles” for scalene triangles shows his description of the behaviour of all scalene triangles as opposed to one particular scalene triangle. Also this description of scalene being able to create any shape of triangles makes inclusion of isosceles and equilateral triangles evident. Thus, Lida and Jory's arguments show 3<sup>rd</sup> level of discourse.



## DISCUSSION AND CONCLUSION

Our preliminary analysis shows that, during the teacher-led explorations and discussions with dynamic sketches, children's routines moved from description of tool-based informal properties to formal properties as well as from particular (1<sup>st</sup> order) to more general (2<sup>nd</sup> order) discourse about 'triangle'. Children's reasoning started with describing the movement patterns like "Everything moves with it except one point", "If I move that one, that one also moves", "wherever you move it, then this one moves with this" and then eventually shifted to formal properties "angles are staying same", "moves symmetrical". Dragging the vertices acted as a visual mediator and helped the children to develop the routine of looking at movement behaviour and eventually shifting towards formal geometrical properties. Jory used the embodied visual mediators (arms as sides of isosceles triangle) for justifying why isosceles triangle can't fit into the outline of a triangle whose sides are different. The use of action verbs "go", "moves", "staying", "paralysed", "getting bigger or smaller" and 'if-then' statements shows children's propensity to reason in terms of motion in case of classification of triangles, which was clearly initiated by the dynamic and temporal elements of DGE. Thom's use of word 'paralysed' for isosceles and equilateral triangle is quite interesting, and clearly emerged after looking at the restrictive type of movement shown by these triangles, which reaffirms Healy and Sinclair's (2007) claim that the temporality of dynamic mathematical presentations offers striking opportunities for narrative thinking.

Also, Lida and Jory's use of inclusive definitions (Villiers, 1994) emerged as a result of dynamic actions of dragging during an attempt to superimpose one triangle over another. This study reaffirms the results of Sinclair & Moss (2012) by providing the evidence of how dynamic environment can help students to move to higher levels of discourse. This study also provides initial evidence that the teaching of concepts like symmetry and angles in early years can lead to whole set of new possibilities of geometric reasoning about shape and space for young children.

## References

- Battista, M. T. (2008). Development of shapemakers geometry microworld. In G. W. Blume & M. K. Heid (Eds.), *Research on technology and the teaching and learning of mathematics: Cases and perspectives* (Vol. 2, pp. 131-156). Charlotte, NC: Information Age Publishing.
- Clements, D. H., & Battista, M.T. (1992). Geometry and spatial reasoning. In D.A. Grouws (Ed.), *Handbook of research on mathematics teaching and learning* (pp. 420-464). New York, NY: MacMillan.
- de Villiers, M. (1994). The role and function of a hierarchical classification of quadrilaterals, *For the Learning of Mathematics*, 14(1), 11-18.
- Fuys, D., Geddes, D., & Tischer, R. (1988). *The van Hiele Model of thinking in geometry among adolescents*. Reston, VA: NCTM.

- Gal, H., & Linchevski, L. (2010). To see or not to see: analyzing difficulties in geometry from the perspective of visual perception. *Educational Studies in Mathematics*, 74, 163-183.
- Healy, L., Sinclair, N. (2007). If this is your mathematics, what are your stories? *International Journal of Computers for Mathematics Learning*, 12, 3-21.
- Jones, K. (2000). Providing a foundation for deductive reasoning: students' interpretations when using dynamic geometry software and their evolving mathematical explanations. *Educational Studies in Mathematics*, 44, 55-85.
- Sfard, A. (2008). *Thinking as communicating: Human development, the growth of discourses and mathematizing*. Cambridge, UK: Cambridge University Press.
- Sinclair, N., & Moss, J. (2012). The more it changes, the more it becomes the same: The development of the routine of shape identification in dynamic geometry environments. *International Journal of Education Research*, 51-52, 28-44.

# IMPROVING STUDENT LEARNING IN MATH THROUGH WEB-BASED HOMEWORK

Kim Kelly<sup>1</sup>, Neil Heffernan<sup>1</sup>, Cristina Heffernan<sup>1</sup>,  
Susan Goldman<sup>2</sup>, James Pellegrino<sup>2</sup>, Deena Soffer-Goldstein<sup>2</sup>

<sup>1</sup>Worcester Polytechnic Institute, <sup>2</sup>University of Illinois Chicago

*Much debate surrounds the effectiveness of the common educational practice of homework (Cooper et al., 2006). A randomized-controlled trial has shown that using a web-based homework system that provides immediate feedback to students, while they are doing their mathematics homework, and detailed item reports to teachers significantly improves student learning. The use of that data also changed the homework review process, leading to a more comprehensive and meaningful review of student errors and misconceptions.*

## INTRODUCTION

Like much of the research in education that has focused on improving student learning, the present study examines the role technology can play in increasing student performance through homework. The common educational practice of homework has been criticized as Cooper et al. (2006) highlight the point that poorly conceived homework does not help learning. However, if we leverage technology to provide immediate feedback while students complete their mathematics homework, can we improve student learning?

Several studies have shown the effectiveness of intelligent tutoring systems (ITS) when used in the classroom (Singh et al. 2011). However, very few studies have explored the effectiveness of ITS when used as homework. Therefore it was very encouraging when Van Lehn et al. (2005) presented favorable results when ANDES, an ITS, was used in this fashion. Yet, most systems are not currently designed to be used for nightly homework. Computer aided instruction (CAI), which gives all students the same questions with immediate end-of-question feedback, is more applicable than complex ITS for nightly homework as teachers can easily build the content from textbook questions or worksheets. Kulik and Kulik's (1991) meta-analysis reviewed CAI and reported a low effect size for simple computer based immediate feedback systems. However, these studies were not in the context of homework use and did not focus on how teachers use the data to respond to student performance. Web-based homework systems (WBH) like WebAssign ([www.webassign.com](http://www.webassign.com)) are commonly used in higher education. These systems are similar to web based computer aided instruction (CAI), providing students immediate feedback and reports to teachers. While VanLehn et al. (2011) reported on three such systems used at the higher education level for physics, there are no known studies at the K12 level that allow this contrast.

In this study we look to measure the effect on learning by comparing simple WBH to a traditional homework (TH) condition representing the type of practice that millions of students perform every night in America and probably around the world. Additionally, we explore how the teacher can use the data to modify and improve mathematics instruction.

The current study employed ASSISTments.org, a web-based intelligent tutoring system to provide “end-of- problem-correctness-only” feedback during homework in the WBH condition. The ASSISTments system was also used for the TH condition by further removing the correctness feedback thus emulating traditional paper and pencil homework assignments. ASSISTments is currently used by thousands of middle and high school students for nightly homework. Students can receive immediate feedback on the homework and the teachers can then access item reports detailing student performance. In the current study we were interested in examining the effects of teacher review of homework performance based on information derived from the ASSISTments system under each of the two different homework conditions. The goal was to estimate the additional effects of teacher-mediated homework review and feedback following each of the two homework practice conditions – TH and WBH – and also study differences in how teachers might approach homework review given variation in student performance following each type of homework practice.

## **EXPERIMENTAL DESIGN**

Participants were 63 seventh grade students, who were currently enrolled in an eighth grade math class, in a suburban middle school in Massachusetts. They completed the activities included in the study as part of their regular math class and homework. Students were assigned to conditions by blocking on prior performance in math class. This was done by ranking students based on their overall performance in ASSISTments prior to the start of the study. Matched pairs of students were randomly assigned to either the TH (n=33) or WBH (n=30) condition.

The study began with a pre-test that was administered at the start of class (see Kelly, 2012 for all study materials and data). This test consisted of five questions, each referring to a specific concept relating to negative exponents. Students were then given instruction on the current topic. That night, all students completed their homework using ASSISTments. The assignment was designed with three similar questions in a row or triplets. There were five triplets and five additional challenge questions that were added to maintain ecological validity for a total of twenty questions. Each triplet was morphologically similar to the questions on the pre-test.

Students in the WBH condition were given correctness-only feedback at the end of the problem. Specifically, they were told if their answer was correct or incorrect. If a student answered a question incorrectly, he/she was given unlimited opportunities to self-correct, or he/she could press the “show me the last hint” button to be given the answer. It is important to emphasize that this button did not provide a hint; instead it provided the correct response, which was required to proceed to the next question.

Students in the TH condition completed their homework using ASSISTments but were simply told that their answer was recorded but were not told if it was correct or not (it said “Answer recorded”). It is important to note that students in both conditions saw the exact same questions and both groups had to access a computer outside of school hours. The difference was the feedback received and the ability for students in the WBH condition to try multiple times before requesting the answer.

The following day all students took post-test1. This test consisted of five questions that were morphologically similar to the pre-test. The purpose of this post-test was to determine the benefit of feedback while doing their homework. At that point, students in the WBH condition left the room and completed an unrelated assignment. To mimic a common homework review practice, students in the TH condition were given the answers to the homework, time to check their work and the opportunity to ask questions. This process was videotaped and can be seen in Kelly (2012). After all of the questions were answered (approximately seven minutes) students in the TH condition left the room to complete the unrelated assignment and students in the WBH condition returned to class. The teacher used the item report, generated by ASSISTments to review the homework. Common wrong answers and misconceptions guided the discussion. This process was videoed and can be seen at Kelly (2012). The next day, all students took post-test2. This test was very similar to the other pre and post-test assessments as it consisted of five morphologically similar questions. The purpose of this test was to measure the value-added by the different in-class review methods.

## **RESULTS**

Several scores were derived from the data collected by the ASSISTments system. Student’s homework average was calculated based on the number of questions answered correctly on the first attempt divided by the total number of questions on the assignment (20 questions). A partial credit homework score accounted for the multiple attempts allowed in the WBH condition. Students were given full credit for answers, provided they did not ask the system for the response. The score was calculated by dividing the number of questions answered without being given the answer by the number of total questions on the homework assignment (20 questions). Time spent on homework was calculated using the problem log data generated in ASSISTments and is reported in minutes. Times per action are truncated at five minutes. Recall that the homework assignment was constructed using triplets. Learning gains within the triplets were computed by adding the points earned on the third question in each triplet and subtracting the sum of the points earned on the first question in each triplet.

### **Learning Gains from Homework**

One student, who was absent for the lesson, was excluded from the analysis (n=63). A t-test comparing the pre-test scores revealed that students were balanced at the start of the study ( $t(61)=0.29$ ,  $p=0.78$ ). However, an ANCOVA showed that students in the WBH condition reliably outperformed those in the TH condition on both post-test1

( $F(1,60)=4.14$ ,  $p=0.046$ ) and post-test2 ( $F(1,60)=5.92$ ,  $p=0.018$ ) when controlling for pre-test score. See Table 1 for means and standard deviations. If the difference was reliable a Hedge corrected effect size was computed using CEM (2013). The effect sizes do not take into account pretest. The key result for post-test2 of 0.56 effect size had a confidence interval of between 0.07 and 1.08.

	TH	WBH	<i>p</i> -value	Effect Size
Pre-Test	9% (17)	7% (14)	0.78	NA
Post-Test1	58% (27)	69% (21)	0.046*	0.52
Post-Test2	68% (26)	81% (22)	0.018*	0.56
HW Average	61% (20)	60% (15)	0.95	NA
Partial Credit HW Score	61% (20)	81% (18)	0.0001*	1.04
Time Spent (mins)	22.7 (9.6)	23.2(6.2)	0.96	NA
Learning Gains	0.03 (0.9)	1.73(1.1)	0.0001*	2.21

Table 1: Means, standard deviations (in parenthesis), and effect size for each measure by condition. \*Notes a reliable difference.

A comparison of homework average shows that students scored similarly ( $F(1,60)=0.004$ ,  $p=0.95$ ). An ANCOVA revealed that when calculating homework performance using the partial credit homework score, students in the WBH condition performed reliably better than those in the TH condition ( $F(1,60)=17.58$ ,  $p<0.0001$ ). This suggests that with unlimited attempts, students are able to self-correct, allowing them to outperform their counterparts. Similarly, comparing learning gains revealed that students with correctness feedback and unlimited attempts to self-correct learned reliably more while doing their homework ( $F(1,60)=45.72$ ,  $p<0.0001$ ).

A review of the item report further describes this difference in learning gains. As expected, students in the TH condition continued to repeat the same mistake each time the question was encountered resulting in three consecutive wrong responses. Conversely, students in the WBH condition may have repeated the mistake once or twice but rarely three times in a row, accounting for the learning.

The first thing that we want to point out is that students in the WBH condition had a significantly lower percentage correct on the first item. Presumably students in the WBH condition would use the hint button when they were not sure of the answer or were willing to guess as they had unlimited attempts. However, in the TH condition, there was no such button, therefore perhaps students were more likely to take other steps such as looking at class notes, asking a parent or calling a friend for help before responding.

The ability to attempt each question multiple times is unique to students in the WBH condition. We suggest that this feature may play an important role in the presented learning gains. While this specific feature was not empirically tested in this study, we can only speculate on its effect. However, it is important to note that students in the WBH condition had on average 49 attempts (standard deviation=24) to answer the 20-question homework assignment. The fewest attempts made by any student was 25

and the most was 140. The average number of times the answer was requested was 4 with a standard deviation of 3.5. This suggests that students in the WBH condition took advantage of the ability to try questions multiple times to learn the material without requesting the correct answer.

We were not expecting that correctness only feedback was going to be time efficient. In fact, students in both conditions spent the same amount of time to complete their homework ( $F(1,60)=0.002$ ,  $p=0.96$ ). However, it appears that the time spent was apportioned differently in the conditions. Specifically, the TH condition took longer to generate a first response, but the WBH condition took time making multiple attempts as well as requesting the answer. It seems that students in the TH group spend more time thinking about the problem but the WBH group can get the problem wrong, and then use their time to learn the content.

### **Learning Gains from Homework Review**

To address the second research question of the effectiveness of using the data to support homework review, a paired t-test revealed that students in both conditions did reliably better on post-test2 than on post-test1 ( $t(62)=3.87$ ,  $p<0.0001$ ). However, an ANCOVA revealed that when accounting for post-test1 scores, there is not a reliable difference by condition in the gains from post-test1 to post-test2 ( $F(1,60)=2.18$ ,  $p=0.15$ ). This suggests that both methods of reviewing the homework lead to substantially improved learning. Interestingly, the results indicate that TH feedback, while students complete homework (69% post-test1), is as effective as receiving no feedback and then having the teacher review of the homework (68% post-test2). This suggests that to save time, teachers may not even need to review the homework if students have access to web-based homework systems.

### **Observational Results**

In addition to examining the effects of immediate feedback on learning, this study explored the potential changes to the homework review process the following day in class. In the TH review, time was spent first on checking answers and then the teacher responded to students' questions. However, in the WBH review the teacher reviewed the item report in the morning to determine which questions needed to be reviewed in class. The item report shows individual student performance as well as class performance at the question level. Common wrong answers are also displayed for each question. The teacher noted that in triplet 2, students incorrectly applied a previously learned concept. Specifically, 39% of students initially got this type of question right (multiplying powers with coefficients and variables). However, learning took place as 68% got the next similar question right. It was therefore puzzling to see that on the third question in that triplet (question number 10), only 45% got the question right. Upon investigating the question, the teacher was able to identify the misconception and therefore addressed it with the class.

We designed the experiment with ecological validity in mind. That is, we wanted the teacher to naturally review the homework, giving students enough time to ask

questions. The hope was that approximately the same amount of time would be spent in each class and by each condition. We were disappointed to find that the classes and conditions varied greatly in the amount of time spent going over the homework. Half of the sections took over nine minutes to review the homework while two of the sections in the TH condition and one in the WBH condition spent substantially less time. This is a threat to the validity of drawing statistical inferences, but given the desire to maintain realistic homework review conditions, these inconsistencies highlight important differences in the homework review methods.

An observational analysis of the video recordings of the teacher reviewing the homework revealed that while the time spent in the WBH condition was often longer than the TH, it was also far more focused than in the TH. Specifically, when students were in the TH condition, on average 1 minute passed before any meaningful discussion took place. Whereas, when students were in the WBH condition, homework review began immediately with the teacher reviewing what she perceived to be the most important learning opportunities.

Other notable differences in the type of review include the number of questions answered. In the TH condition, 2 classes saw 3 questions each and one saw 7. However, in the WBH condition each class saw 4 targeted questions and 2 classes requested 1 additional question. The variation in question types also is important to note. The teacher was able to ensure that a variety of question types and mistakes were addressed whereas in the TH condition students tended to ask the same types of questions or even the same exact question that was already reviewed. Additionally, students in the TH condition also asked more general questions like “I think I may have gotten some of the multiplying ones wrong.” In one TH condition only multiplication questions were addressed when clearly division was also a weakness and similarly, another TH condition only asked questions about division. This accounts for much of the variability in overall review time.

In listening to the comments made by students it appears that the discussion in the TH condition was not as structured as the WBH condition. Not all students had their work and therefore couldn't participate in the review. One student said, “I forgot to write it down.” Another said, “I left my work at home.” Because students were asking questions and the teacher was answering them, we suspect that only the student who asked the question was truly engaged. In fact, one student said, “I was still checking and couldn't hear” which led to the teacher reviewing the same question twice. In the WBH condition, the teacher used the information in the report, such as percent correct and common wrong answers to engage the entire class in a discussion around misconceptions and the essential concepts from the previous question.

Other notable differences include the completeness of the review. In the TH condition, the review was dominated by student directed questions. This means that each class experienced a different review and the quality of that review was directly dependent on the engagement of the students. Conversely, in the WBH condition, all 3 classes were presented with the same 4 troublesome questions and common mistakes. Additional



questions were reviewed when asked (as in two sections) but the essential questions as determined by the data in the item report were covered in all three sections.

### **Student Survey Results**

Following participation in this study, students were questioned about their opinions. We want to acknowledge that students might have been telling the teacher what she wanted to hear: the whole classroom of students had been using ASSISTments for months and the teacher had told them on multiple occasions why it's good for them to get immediate feedback. So with that caveat, we share the following results. 86% of students answered ASSISTments to the question "Do you prefer to do your homework on ASSISTments or a worksheet?". 66% mistakenly think that it takes longer to complete their homework when using ASSISTments (we showed in this study that that was not the case) and 44% feel that they get frustrated when using ASSISTments to complete their homework. However 73% say that their time is better spent using ASSISTments for their homework than a worksheet. When asked what students like best about ASSISTments, student responses included:

"That if you get stuck on a problem that it will give you the answer."

"You can redo your answer if you get it wrong and learn from your mistakes."

"How it tells you immediately that you are right or wrong."

"I like how I know if I'm right or wrong. This helps because often times when I get things wrong I just go back to my work and I see what I'm doing wrong which helps me when doing other problems."

While the learning benefits are profound and students prefer a web-based system, there is a sense of frustration that must still be addressed. Specifically, student feedback suggests that students appreciate the features of intelligent tutoring systems, including hints, worked examples and scaffolding. Therefore, future studies should explore adding additional feedback to determine if added AIED features improve learning or if maybe learning requires some levels of frustration. All of the survey results are made available without names, including students' comments at <http://www.webcitation.org/6DzciCGXm>.

### **DISCUSSION**

This paper's contribution to the literature is exploring the potential use of ITS for mathematics homework support. Used as designed, ITS are somewhat cumbersome for teachers to use for homework as the content is not customizable. However, if ITS were simplified they could be used like web-based homework systems, providing correctness feedback to students and reports to teachers. This begs the question, is correctness only feedback enough to improve the efficacy of homework and what effect does teacher access to reports have on homework review? This randomized controlled study suggests that simple correctness-only feedback for homework substantially improves learning from homework. The benefit of teachers having the data to do a more effective homework review was in the expected direction (but not

reliable). But taken together (immediate feedback at night and an arguably smarter homework review driven by the data) the effect size of 0.56 seems much closer to the effect of complex ITS. Of course the large 95% confidence interval of [0.07 to 1.08] tells us we need more studies.

Future studies can explore features of other web-based homework systems like Kahn Academy to determine which aspects of the systems are particularly effective. Incrementally adding tutoring features to determine the effectiveness of each feature would also be valuable. Finally, the role of data in formative assessment should be further explored. In what way can teachers use the data to improve homework and review and instruction?

In this fast-paced educational world, it is important to ensure that time spent in class and on mathematics homework is as beneficial as possible. This study provides some strong evidence that web-based homework systems that provides correctness-only feedback are useful tools to improve mathematics learning without additional time.

### **Acknowledgement**

Funding for this work was provided by US Dept of Ed: IES grant # R305C100024.

### **References**

- CEM. (2013). Effect size calculator [software]. Retrieved from <http://www.cemcentre.org/evidence-based-education/effect-size-calculator>
- Cooper, H., Robinson, J. C., & Patall, E. A. (2006). Does homework improve academic achievement? A synthesis of research, 1987-2003. *Review of Educational Research*, 76(1), 1-62.
- Kelly, K. (2012). *Study materials*. Retrieved from <http://www.webcitation.org/6E03PhjrP>
- Kulik, C. C., & Kulik, J. A. (1991). Effectiveness of computer-based instruction: An updated analysis. *Computers in Human Behavior*, 7, 75-94.
- Singh, R., Saleem, M., Pradhan, P., Heffernan, C., Heffernan, N., Razzaq, L., ... Mulchay, C. (2011). Feedback during web-based homework: the role of hints. In G. Biswas, S. Bull, J. Kay, & A. Mitrovic (Eds.), *Proceedings of the Artificial Intelligence in Education Conference 2011* (Vol. 6738, pp. 328-336). Berlin, DE: Springer.
- VanLehn, K. (2011). The relative effectiveness of human tutoring, intelligent tutoring systems, and other tutoring systems. *Educational Psychologist*, 46(4), 197-221.
- VanLehn, K., Lynch, C., Schulze, K. Shapiro, J. A., Shelby, R., Taylor, L., ... Wintersgill, M. (2005). The Andes physics tutoring system: Lessons learned. *International Journal of Artificial Intelligence and Education*, 15(3), 1-47.

# THE QUALITY OF ARGUMENTATIONS OF FIRST-YEAR PRE-SERVICE TEACHERS

Leander Kempen, Rolf Biehler

University of Paderborn

*In this paper we report our findings from a study, in which 177 undergraduate pre-service teachers had to verify a statement of elementary number theory at the onset of a lecture serving as a bridging course. The answers were categorized to investigate the qualities of the given argumentations. We also separated the results of three different subsets: (1) the of students in their first semester, to get to know their level of arguing after having past their A-Levels, (2) the students, that take part in this course the first time and are in a higher semester and (3) the subset of repeaters to investigate their problems in detail.*

## INTRODUCTION

One of the greatest problems in the transition from school to university mathematics is the new role of proof at university level. Selden (2012, p. 392) identifies the nature of proof and its increased demand for rigour at University as a major hurdle for many beginning university students. In Germany, this problem got recently even more severe, because the number of school years necessary for going to university was reduced from 13 to 12 years (so called “G8”). Moreover, proof plays a decreasing role in the practice of school mathematics teaching.

The University of Paderborn offers the course “Introduction into the culture of mathematics” specifically designed as a bridging course in the first term in order to help students to successfully accomplish the transition to university. This course is a requirement for the first year secondary pre-service teachers (non grammar schools). Since one of the main focus of the course is on argumentation and proof, the lecture deals with mathematical “research” in the field of elementary arithmetic, different kinds of argumentations (e.g., generic proofs), logic, formalization and formal proofs. The aim of this paper is to report on the study concerning the argumentation skills of the students at the beginning of the course and to identify common gaps or pitfalls in their argumentations.

## RELATED RESEARCH

There is a large variety of research on proof competencies of school students shortly before matriculation. In the TIMS-Study in 1998 mathematics students in their final year of secondary school were asked to write a proof. Of all ten countries tested, the German students received the worse results: Only 21% were able to construct a valid proof (Reid & Knipping, 2010, p. 68). Reiss and Heinze (2000) showed that the larger part of German school students in their survey was not able to use deductive arguments

when trying to construct a proof. Moreover, in the study of Reiss, Klieme and Heinze (2001) only a few students were able to use their mathematical knowledge to build up an argumentation in order to prove a given statement. But this problem is not limited to the German school system. Reiss and Ufer summarize their international research review on students' proving skills as follows: "A coherent result, which is reflected in the empirical studies on mathematical proofs in school mathematics, is the poor performance of pupils concerning reasoning and argumentation" (Reiss & Ufer, 2009, p. 164; translated by the author).

Similar problems are known for undergraduates and pre-service teachers, when trying to prove a statement. Common are problems with mathematical knowledge (definitions, notation, etc.) and a lack of methodological knowledge (e.g., Moore, 1994; Weber, 2001). Biehler and Kempen (2013) investigated students' ability in constructing generic proofs and formal proofs and found serious deficits in the proof production of pre-service teachers concerning the deductive reasoning and the handling of algebra.

## **RESEARCH QUESTIONS**

We are investigating the development of the students' proving skills during the course in the context of the first author's dissertation. Therefore it was necessary to look at the argumentation skills at the beginning of the course. We also wanted to have a look at students' problems when building up an argument. Since the group of participants is heterogeneous, we chose with the following questions:

4. What kind of argumentation skills have the students at the beginning of the course?
5. What are the differences in the argumentations of the students in their first semester at university, of the students in a higher semester that are taking the course for the first time and the students that once failed the final exam of the course and are now doing it for the second time?
6. Are there specific problems in the solutions of the subset of the repeaters? What are these?

## **METHODOLOGY**

In the first session of the course, the students were given a questionnaire with items concerning argumentation and proving, attitudes towards proving, the nature of mathematics and the nature of mathematics teaching. In this paper, we will discuss the analysis of the first item of the questionnaire, which demanded argumentation skills (proving skills) of the students.

### **Task and task analysis**

The first task of the questionnaire, which we will discuss in detail here, is the following:

*The sum  $11 + 17$  is an even number  
Is this true for every sum of any two odd numbers?  
- Argue convincingly!*

We deliberately asked for arguing convincingly, because the demand to “prove” a certain statement implicates for many students the use and handling of algebra. Since the idea here is not to get to know what the students consider to be a “proof” or what constitutes a “proof” for them, but how they construct a “convincing argumentations” for an infinite number of cases for themselves and/or others.

It is possible to answer this question with only basic knowledge of elementary arithmetic and algebra. One may argue without using variables, constructing a narrative proof (describing your valid argumentation with words) or a generic proof (explaining your valid argumentation in a concrete context, i.e. concrete examples or geometric diagrams) or one may use variables to compute algebraic expressions and argue with the final term.

We categorized the students’ answers to investigate the quality of the given arguments. To analyze this aspect more in detail, we also categorized the following aspects: The use of variables, the way of argumentation, the use of examples and the type of gap in the argumentation. Due to the size of this paper, we will only address the main dimension: The quality of argumentation.

### Analysis of the data

For analysing the quality of arguments, we looked for appropriate categories in the literature. Bell (1976) identified several levels for categorizing pupils’ proof productions. Using as first division between empirical and deductive areas, he built up a set of categories regarding the quality of argumentation. In the following years proof productions were mainly analysed to identify different *proof schemes* that are describing students’ ability in proving: “A person’s proof scheme consists of what constitutes ascertaining and persuading for that person” (Harel & Sowder, 1998, p. 244). Recio and Godino (2001) adapted the approach of Harel and Sowder to investigate the proof schemes of students starting their studies at University. Since the set of categories of Bell (1976) and Recio and Godino (2001) complete each other, we combined their categories and modified them for our study. We finally came up with the following set of categories.

### Set of categories

- **C99: no answer is given.**
- **C0: no argumentation is given.** (See Figure 1.)

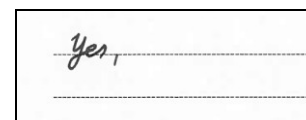

Figure 1: A student answer, which belongs to the category C0.

Empirical argumentations

- **C1: illustration.** The truth of the general statement is illustrated by several examples. (See Figure 2.)
- **C2: empirical verification.** The truth of the general statement is inferred from a subset of examples. (See Figure 3.)

The sum of two odd numbers is always an even number.  
 Examples:  $11+17=28$   
 $9+13=22$   
 $5+5=10$

Figure 2: A student answer, which belongs to the category C1.

Yes, I tried the general statement with several numbers.  
 $3+3=6$  even  
 $7+5=12$  even  
 $13+7=20$  even  
 The sum of any two odd numbers is always even.

Figure 3: A student answer, which belongs to the category C2.

Deductive types of argumentations

- **C3: pseudo-verification by just repeating the statement to be proved.** The answer is given by stating the statement that the sum of any two odd numbers is always even. (See Figure 4.)
- **C4: pseudo-verification by pseudo argumentation.** The verification is done by an explanation that merely paraphrases the statement that the sum of two odd numbers is always even. (See Figure 5.)

Yes, because the sum of two odd numbers is always even.

Figure 4: A student answer, which belongs to the category C3.

Yes, it is true for every sum of any two odd numbers, because they are always divisible by 2.

Figure 5: A student answer, which belongs to the category C4.

- **C5: pseudo argument, mathematically wrong.** The arguments given are either non relevant for the task or mathematically wrong. (See Figure 6.)
- **C6: relevant details, but fragmentary.** The answer contains relevant aspects that could form part of a proof, but the student fails to build up a coherent argument. (See Figure 7.)

Considering odd numbers as halves of apples and adding them, one gets one whole apple, which represents in this context an even number.

Figure 6: A student answer, which belongs to the category C5.

Yes, because an odd number is always followed by an even number. To be exact, first there is an even number, then an odd number and then again an even number, etc. If one adds two odd numbers, it is logical, that the sum is even.

Figure 7: A student answer, which belongs to the category C6.

- **C7: connected arguments with unrecoverable gap.** The student gives a connected argument with explanatory quality, but the argumentation includes an unrecoverable gap. (See Figure 8.)
- **C8: connected argument, but incomplete.** The student gives a connected argument with explanatory quality, but the argumentation is incomplete. – Here one could close the created gap by adding some sentences. (See Figure 9.)

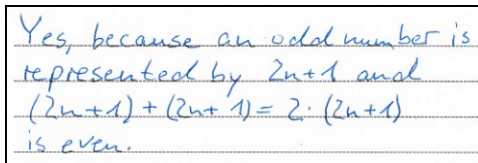

Yes, because an odd number is represented by  $2n+1$  and  $(2n+1)+(2n+1)=2 \cdot (2n+1)$  is even.

Figure 8: A student answer, which belongs to the category C7.

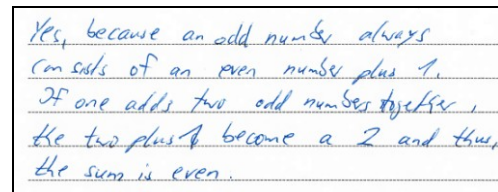

Yes, because an odd number always consists of an even number plus 1. If one adds two odd numbers together, the two plus 1 become a 2 and thus, the sum is even.

Figure 9: A student answer, which belongs to the category C8.

- **C9: complete explanation (a) - with minor (formal) inaccuracies.** The student derives the conclusion by a connected argument and from generally agreed facts of principles. Just because of minor (formal) inaccuracies the explanation is not a perfect verification. (See Figure 10).
- **C10: complete explanation (b).** The student derives the conclusion by a connected argument and from generally agreed facts of principles. (See Figure 11.)

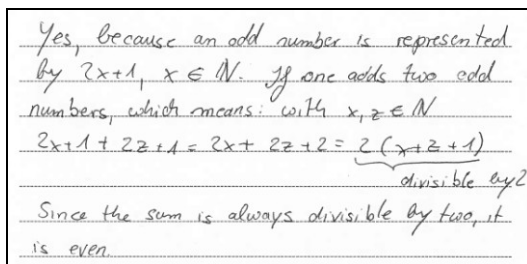

Yes, because an odd number is represented by  $2x+1$ ,  $x \in \mathbb{N}$ . If one adds two odd numbers, which means: with  $x, z \in \mathbb{N}$   $2x+1 + 2z+1 = 2x + 2z + 2 = 2(x+z+1)$  divisible by 2. Since the sum is always divisible by two, it is even.

Figure 10: A student answer, which belongs to the category C9.

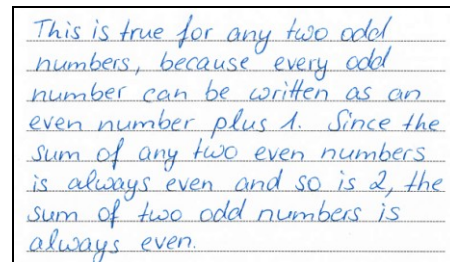

This is true for any two odd numbers, because every odd number can be written as an even number plus 1. Since the sum of any two even numbers is always even and so is 2, the sum of two odd numbers is always even.

Figure 11: A student answer, which belongs to the category C10.

## RESULTS

Apart from analyzing the answers of the whole group [ $n = 177$ ], we also looked at three different subgroups: (1) the subset of the students in their first semester at university [ $n = 69$ ], (2) the students, that take part in this course the first time and are in a higher semester [ $n = 58$ ] and (3) the subset of the repeaters, the students that have failed the final exam in a previous semester and now have to do the course again [ $n = 50$ ]. Thus, it is possible to get an overview of the argumentation and proving skills of all participants, to evaluate the competencies of the first-year students, to investigate the problems of the students that once failed the exam and also to have a look at the students, that are in a higher semester, but take the course for the first time. Figure 12 shows the quantitative results, clustered in the following way: “emp.” combines the empirical argumentation subcategories [C1+C2]; “pseudo” combines the pseudo

argument subcategories [C3+C4+C5]; “v.a.” (valid arguments) combines subcategories with valid arguments, but without a complete explanation [C6+C7+C8], whereas “c.e.” with a complete explanation [C9+C10].

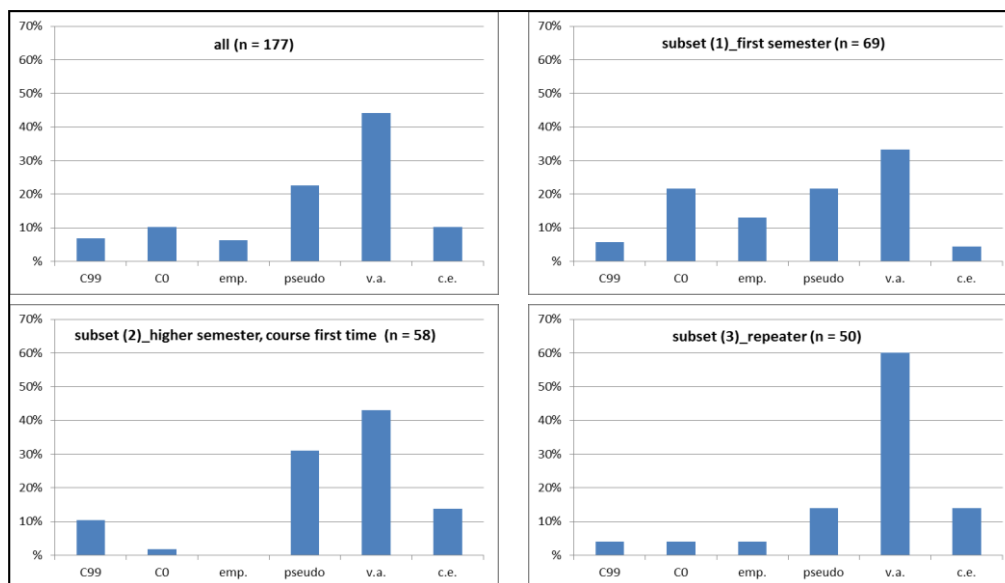

Figure 12: Frequencies of answer types.

Results concerning all students [Figure 12, top left]:

Regarding all tests 12 students did not answer the task. 18 students (10.17%) did not argue why the statement is true [C0] and 11 (6.21%) used an empirical approach [emp.]. In 40 answers (22.60%) there were only pseudo-arguments mentioned [pseudo]. 96 persons (54.24%) gave correct arguments [v.a.+c.e.] and 18 argumentations of these (10.17%) were rated as “complete explanations” [c.e.].

Results of subset (1) [Figure 12, top right]:

Considering the subset of students in their first semester, 15 solutions (21.74%) did not contain any argumentation [C0] and an empirical approach was used by 9 persons (13.04%). Pseudo-arguments were given by 15 students (21.74%) and out of the 30 answers (43.48%) with correct arguments [v.a.+c.e.] there are 3 (4.35%) “complete explanations”.

Results of subset (2) [Figure 12, bottom left]:

In this group only one student gave an answer without argument and no one used an empirical approach. A pseudo-argument was given by 18 students (31.03%). Out of the 33 answers (56.90%) with correct arguments [v.a.+c.e.], we rated 8 (13.79%) as “complete explanation”.

Results of subset (3) [Figure 12, bottom right]:

In the subset (3) “repeater”, only 2 (4.00%) persons used empirical considerations and 7 students (14.00%) gave wrong pseudo-arguments. In 28 answers (56.00%) we found a serious gap in the argumentation [C7] and only 7 students (14.00%) achieved a “complete explanation”.



Comparison of the argumentations given:

The answers of the students in their first semester displayed a variety of arguments combined with different types of argumentations (e.g. narrative proof, generic proof, etc.). 13 of these students, and also 10 students in a higher semester, who took the course for the first time, argued with properties of even and odd numbers, without using algebra. In the subset of repeaters all students, who argued with correct arguments used formalization and algebra for their argumentation.

Specific problems in the solutions of the subset of the repeaters:

As mentioned above, all repeaters, that gave correct arguments, did this by formalization and algebra. But in 28 of all 37 cases, the students only used one variable for representing any two odd numbers and therefore failed to verify the statement.

**DISCUSSION**

To sum up, only 6.21% of all answers contained a purely empirical approach. This result is inconsistent with many studies: In the survey of Barkai et al. (2002) about 52% of elementary teachers offered an empirical argument when asked to justify a statement of elementary number theory (see also Reid & Knipping, 2010, p. 68).

In the subset of the first-year students, about 13% tried to verify the statement by empirical arguments and 43.48% of these students were able to argue with valid arguments. But only 3 of them gave an argumentation we could consider as valid verification. Since the given task is a basic (nearly trivial) theorem of elementary number theory, which is easy to verify, this result is distressing. We have indications that the mathematical education at school in Germany does not provide future students for secondary teacher studies in mathematics with many skills to work on a proving task. However, we have not taken a representative study. But the results reinforce the need of our bridging course.

The problems of the repeaters are distinct, too. In this elementary task, only 37 students (74%) gave a valid argument in their argumentation. All these 37 answers used formalization and algebra, but 28 of these failed to represent any two odd numbers, because of using only one variable. It seems obvious, that the problems in using variables and algebra lower the argumentation skills of many students. This finding is in line with the literature (e.g., Epp, 2011).

One can identify several challenges for the teaching of arguing and proving at university level: In our study, these first-year students in Germany are not equipped with argumentation skills which are a requirement for learning to prove. It seems, as if mathematics at school does not provide the future students with adequate heuristics for problem-solving and basic proving skills. These findings underline the importance of courses like the "Introduction into the culture of mathematics". Therefore bridging courses have to start with basic skills for arguing and proving. Here, it is important to emphasize the meaning of informal arguments in order to stress the quality of a given

argumentation. If we highlight the possibility to formalize an informal argument we also underline the function and value of using algebra and variables in mathematics.

## References

- Barkai, R., Tsamir, P., Tirosh, D., & Dreyfus, T. (2002). *Proving or refuting arithmetic claims: The case of elementary school teachers*. In A. D. Cokburn & E. Nardi (Eds.), *Proc. 26<sup>th</sup> Conf. of the Int. Group for the Psychology of Mathematics Education* (Vol. 2, pp. 57-64). Norwich, UK: PME.
- Bell, A. W. (1976). A study of pupils' proof-explanations in mathematical situations. *Educational Studies in Mathematics*, 7, 23-40.
- Biehler, R., & Kempen, L. (2013). *Students' use of variables and examples in their transition from generic proof to formal proof*. Paper presented at the 8<sup>th</sup> Congress of European Research in Mathematics Education (CERME 8). Retrieved from [http://cerme8.metu.edu.tr/wgpapers/WG1/WG1\\_Kempen.pdf](http://cerme8.metu.edu.tr/wgpapers/WG1/WG1_Kempen.pdf)
- Epp, S. (2011). Variables in mathematics education. In P. Blackburn, H. van Ditmasch, M. Manzano, & F. Soler-Toscano (Eds.), *Tools for teaching logic* (pp. 54-61). Berlin/Heidelberg: Springer.
- Harel, G., & Sowder, L. (1998). Students' proof schemes: Results from exploratory studies. *Research in Collegiate Mathematics Education III*, 7, 234-282.
- Moore, R. C. (1994). Making the transition to formal proof. *Educational Studies in Mathematics*, 27(3), 249-266.
- Recio, A. M., & Godino, J. D. (2001). Institutional and personal meanings of mathematical proof. *Educational Studies in Mathematics*, 48, 83-99.
- Reid, D. A., & Knipping, C. (2010). *Proof in mathematics education*. Rotterdam: Sense.
- Reiss, K. (2002). Argumentieren, Begründen, Beweisen im Mathematikunterricht. *Projektserver SINUS Bayreuth*. Retrieved from <http://blk.mat.uni-bayreuth.de/material/db/59/beweis.pdf>
- Reiss, K., & Heinze, A. (2000). Begründen und Beweisen im Verständnis von Abiturienten. In M. Neubrand (Ed.), *Beiträge zum Mathematikunterricht 2000* (pp. 520-523). Hildesheim, Berlin: Franzbecker.
- Reiss, K., Klieme, E., & Heinze, A. (2001). Prerequisites for the understanding of proofs in the geometry classroom. In M. van den Heuvel-Panhuizen (Ed.), *Proc. 25<sup>th</sup> Conf. of the Int. Group for the Psychology of Mathematics Education* (Vol. 4, pp. 97-104). Utrecht: PME.
- Reiss, K., & Ufer, S. (2009). Was macht mathematisches Arbeiten aus? Empirische Ergebnisse zum Lernen von Argumentationen, Begründungen und Beweisen. *Jahresbericht der Deutschen Mathematiker-Vereinigung*, 111(4), 155-177.
- Selden, A. (2012). Transitions and proof and proving at tertiary level. In G. Hanna & M. de Villiers (Eds.), *Proof and proving in mathematics education: The 19<sup>th</sup> ICMI study* (pp. 391-422). Heidelberg: Springer Science + Business Media.
- Weber, K. (2001). Students' difficulty in constructing proofs: The need for strategic knowledge. *Educational Studies in Mathematics*, 48(1), 101-119.

# VIDEO-BASED MEASUREMENT OF PRIMARY MATHEMATICS TEACHERS' ACTION-RELATED COMPETENCES

Imke Knievel, Anke Lindmeier, Aiso Heinze

Leibniz Institute of Sciences and Mathematics Education, Kiel, Germany

*Teacher cognition is seen as an important factor for the quality of instruction and, accordingly, student learning of a subject. However, in-depth research on these relations can only be done if a sound theoretical model for subject-specific teacher cognition (knowledge and competence/practical skills) and corresponding measures are available. This work aims at the development of reliable and valid measures for primary school teachers in mathematics. The subject-specific cognition is modeled as basic professional knowledge (BK) and further two components of reflective competence (RC) and action-related competence (AC). Using video-based items, we developed a computer-based standardized test and collected data of  $N = 85$  primary mathematics teachers. We present results on the quality of the measures and have a closer look on the structure of teacher cognition.*

## MEASURING TEACHER KNOWLEDGE

Despite the broad consensus of the importance of teachers' subject-specific cognition for the instructional quality of lessons and the learning of students, concepts to model these cognitive structures are still deficient. As a consequence, research is still narrow and focuses on single aspects of teacher cognition (Kunter, & Klusmann, 2010). For example, the facets of mathematics teachers professional *knowledge* has been elaborately described based on Shulman's (1986) topology and measures for mathematics teachers' *content knowledge* (CK) and *pedagogical content knowledge* (PCK) were developed successfully (e.g. COACTIV for secondary teachers in Germany, Baumert et al., 2010; MKT for elementary teachers in the US, Hill et al., 2004; TEDS-M for pre-service teachers in various countries, Döhrmann, & Blömeke, 2012). Some studies provided evidence that teacher knowledge is positively related to instructional quality and student learning (Baumert et al., 2010; Hill et al., 2007).

These results strengthen the assumption that subject-specific professional knowledge of teachers guides their instructional actions (see also Hattie, 2009). It is consensus that teacher knowledge is highly specialized, context-bound, and needs to be flexible in order to cope successfully with emerging classroom situations. But so far there is little specific evidence how teachers use their subject-specific knowledge to create and conduct instruction. Moreover, the relationship between teacher knowledge and the ability to use this knowledge in and for action is considered as complex and divergent. Particularly, this divergence can be described by the two commonly known phenomena of *inert knowledge* and *tacit knowledge*: Knowledge can be inert, so that a teacher might perform a knowledge test well, but is not able to utilize this knowledge

in classroom situations. Contrary, if teachers hold tacit knowledge, they react well during classroom situations, but are not able to make this practical knowledge explicit in a knowledge test (Lindmeier, 2011).

To address these issues, alternative approaches have been developed in order to investigate facets of teachers' cognition "beyond" knowledge: Research is then focused on usable teacher knowledge (e.g. Kersting et al., 2012), on professional vision as knowledge-based process (e.g. Stürmer et al., 2013; Vondrová, & Žalská, 2013) or on constructs of competence (our approach, see below). All of these approaches account for the importance of the applicability of teacher knowledge and, hence, seek for valid methods to tests the applicability in standardized procedures. As video-vignettes are seen as a possibility to convey the typical demands of teaching, all these approaches make use of them. However, the ways of using the video-vignettes differ and are very specific for each approach (see Lindmeier, 2013).

### **TEACHERS' SUBJECT-SPECIFIC COMPETENCE**

Our approach accounts for the variety of cognitive demands of typical tasks of teaching and considers knowledge, skills, and abilities needed to master these demands. In a European tradition, we use the concept of competence to model these complex ability constructs (Koeppen et al., 2008). Therefore, we understand subject-specific teacher competences as learnable, highly context-specific, individual cognitive dispositions that are required to master the typical demands of teaching a subject, in our case mathematics. In general, there are two groups of typical teacher tasks that clearly differ in their cognitive demands: (1) Tasks that occur during preparation and post-processing of instruction and are coined by reflective demands, e.g. choosing an appropriate representation and/or correcting students work, and (2) tasks that are related to the instruction itself and characterized by the spontaneous, immediate, interactive, and concurrent demands of teaching. Accordingly, Lindmeier (2011) suggest a subject-specific model for teacher cognition with three components: A *basic knowledge* (BK) component comprising teacher knowledge (CK and PCK). Two complementary components of competences are conceptualized as *reflective competences* (RC), and *action-related competences* (AC). The RC holds abilities and skills required for pre- and post-instructional tasks, whereas the AC comprises the abilities needed to fulfill the demands during instruction. Thus, for both components, basic knowledge is seen as a prerequisite that has to be enacted in situations related to teaching mathematics. However, the way of using this knowledge differs, as aims, situations, and retrieval modes differ between out- and in-classroom teacher work.

In a feasibility study with video-based measures, the components could be separated empirically for secondary in-service (N = 28) and prospective (N = 22) teachers (Lindmeier, 2011). A replication with a larger sample has to follow. In the present study, we followed the approach to model the subject-specific cognition of primary mathematics teachers.

## **Primary school teachers in Germany**

Primary school teachers in Germany teach up to grade 4 and are specialized in one or two subjects. Typically, the children are taught mainly by a class teacher, which implies that mathematics is also taught by teachers without formal education for this subject. For Germany, Richter et al. (2012) report that up to 48% of primary teachers teach mathematics as not-certified teachers in some federal states. Clearly, German pre-service teachers that are educated as “primary generalists” exhibit a significantly lower content-specific knowledge than pre-service teachers that are “primary mathematics specialists” (Senk et al., 2013). It is assumed that this lack of subject-specific knowledge affects the quality of instruction and, hence, student learning. However, the findings are inconsistent for this assumption (for Germany: Richter et al., 2012; Tiedemann, & Billmann-Mahecha, 2007; for an international overview: Hattie, 2009). In addition, these findings rely usually on measures of teacher knowledge (at best, or even only on information about certification) and do not account for possible differences of teacher abilities to use this knowledge in and for instruction, as apt measures are still missing.

## **Competence structure**

If teacher competences “beyond” knowledge can be measured, the relation between knowledge and competences could be investigated. This can be used to describe different profiles of teacher cognition, to identify favorable profiles, and thus lay ground for evidence-based specific professional development programs, e.g. for not-certified teachers. As mentioned above, we assume that the BK is a prerequisite for the two competence components. For the interaction between RC and AC two assumptions can be derived theoretically: On the one hand, considerations that account for the instruction-related knowledge as highly-specialized craft knowledge that is in addition strictly situated in practice (Leinhardt, & Greeno, 1986) may lead to the hypothesis that AC and RC do not show any relation beyond their common rooting in BK (“independent AC/RC hypothesis”). On the other hand, other views on the work of a teacher as reflective practitioner (Schön, 1990) would lead to the expectation that RC plays a mediating role between knowledge and AC (“mediating RC hypothesis”). Lindmeier (2011) found indications for the independency of RC and AC for secondary teachers.

## **RESEARCH QUESTIONS**

The aim of our study was to adapt the three-component model of teacher cognition for primary mathematics teachers and develop standardized measures for individual diagnosis of the components in order to allow for a structural investigation of teacher cognition. Therefore, we worked on the following research question: (1) Is it feasible to develop valid and reliable instruments to assess the subject-specific components of primary teachers as BK, RC, and AC? (2) Which relations will prevail between the assessed competences? In particular, how are the relations between BK, RC, and AC?

## METHODS

### Sample

Overall,  $N = 85$  teachers participated in our studies. All participants of this convenience sample teach mathematics at primary schools in Schleswig-Holstein (a federal state of Germany). The age of the teachers ranges between 25 and 63 years ( $M = 45.3$ ). The majority of the participants were female (89.4%) and nearly half of the sample (51.8%) was certified in mathematics.

### Instruments

For adequate competence measures, items have to reflect appropriately the context-specific demands that were used to conceptualize the competence (Koeppen et al., 2008). Overall, we realized our measures as standardized, computer-based tests. We used the software vKID (Lindmeier, 2011), where a variety of item types can be realized. Specifically, we tailored the items to mirror the characterizing demands of the three components BK, RC, and AC. As mentioned before, items based on video-vignettes are considered as especially suited to convey the demands of teaching, as they account for the complexity of instructional situations. Moreover, recent studies illustrated that video-based items are indeed appropriate to elicit teacher abilities that go “beyond” teacher knowledge (see above).

Hence, for the *AC* measure, we developed short video-vignettes of typical classroom situations from primary mathematics instruction. Since *AC* is especially characterized by its spontaneous and immediate demands, we used a direct oral answer format. Teachers had to answer under time pressure and their reactions were audio recorded. Due to the spontaneous oral answers, this item type differs from other video-based approaches and has been already successfully implemented by Lindmeier (2011). *AC* was measured with 8 items by two types of video-based item: Some items were focused on the teachers’ abilities to address “students’ cognition” and teachers had to cope with a student’s individual strategies and misconceptions. The other items focused on abilities to deal with “representations and explanations” in instruction. The *RC* (9 items) was captured by picture- or video-based items and the teachers’ answers were partly direct and audio recorded, partly written. According to the conceptualization of *RC*, the teachers were instructed to act as they were in a post- or pre-lesson period. They were allowed to have sufficient time for reflection. We used two different types of items within the *RC* measure: First, the item type “students’ cognition” focused on the evaluation of student work, so that e. g. the rationale of a systematical error had to be analyzed. Second, the item type “representation and explanation” focused on planning snippets of lessons that can be related to a given video-vignette. Finally, the *BK* (9 items) was assessed with items comparable to the items from other studies with focus on teacher knowledge (see above, Döhrmann, & Blömeke, 2012, Hill et al., 2004). However, we presented the items via computer, so that the teachers answered written items by typing their answer. The items were constructed to mirror content knowledge as well as pedagogical content knowledge.

However, we do not differentiate these in our analyses. We restricted the content for the whole test to arithmetical topics such as numbers, the place-value system, arithmetical strategies, and operations. The teachers completed the test individually at their own pace (they needed 42-88 min,  $M = 68$  min to answer the test). In the beginning, a technical introduction with sample items was given to avoid technical issues with the handling of the computer. Furthermore, information on background variables was collected, including information on variables to assess criterion-irrelevant difficulties depending on the computer usage.

All audiotaped answers were transcribed before two trained persons coded them independently with a detailed manual. The codes were based on findings from primary mathematics education and accounted for aspects of high-quality instruction. The inter-rater reliability was moderate to high with a range of Cohen's Kappa of  $\kappa = .74-.94$ . The rate of missing data due to skipped items (time-on-task  $< 2$  sec), skipped videos or technical problems was low (2.0%). We handled the missing information in background variables by case-wise deletion. Missing data in knowledge and competence measures is accounted for by using individual mean values of the answered items per scale (relative solution rates). Further, we used a cut-off value, so that scores were only computed if at least 75% of the data per scale was available. The missing data technique we used is discussed, as the resulting bias was not systematically assessed so far. However, if the rate of missing data is low and the mean item solution rates for items with missing data and without is comparable, it is seen as not problematic (Enders, 2010).

## RESULTS

### Feasibility: Reliability and Validity

For evaluating the feasibility of measuring the three proposed scales, we assessed the reliability in terms of internal consistence (Cronbach's Alpha) and compared it to the overall scale. The results of the analyses are reported in Table 1.

Scale	Cronbach's Alpha (Precision)	Est. Cronbach's Alpha <sup>1</sup> for scale length 11	Solution Rates (SD)
BK (7 items)	.68 (.03 )	.77	.55(.12)
RC (7 items)	.64 (.04)	.73	.49(.20)
AC (8 items)	.69 (.02)	.76	.38 (.15)
Overall scale (22 items)	.83 (.01)	.70	.47(.17)

<sup>1</sup>Spearman-Brown prediction formula.

Table 1: Cronbach's Alphas and estimated Cronbach's Alphas for scale size 11

The BK and RC scale had to be reduced by two items each, due to obvious item misfit or/and extreme item difficulties. The reliabilities of the intended scales are sufficient considering the heterogeneous item types. Furthermore, the estimated Cronbach's Alphas for the BK, RC, and AC scale show slightly higher internal consistencies than the overall scale. Thus, the three scales could be used as intended.

In order to evaluate the criterion validity, the *mathematics certified teachers* are compared with the *not-mathematics-certified teachers*. Table 2 shows the results of a t-test between the groups. The mean differences for BK, RC, and the overall scale are of medium to high effect size. But for AC, no statistically significant difference between the groups was found.

Scale	Certified Teachers N = 43	Not-certified Teachers N = 41	t(82)	Effect Size Cohen's d
BK	64.63	46.62	3.91**	.87
RC	55.58	41.68	2.82*	.62
AC	37.39	37.39	0.00 n.s.	.00
Overall scale	52.10	41.69	2.86*	.63

Table 2: T-Test for group differences between math-certified and not-math-certified teachers (\* p < .01, \*\* p < .001)

### Competence Structure: Relations between the three components

Correlations were used to assess the relations between BK, RC, and AC. We found BK significantly related to RC ( $r(84) = .53, p < .01$ ) and AC ( $r(84) = .26, p < .05$ ). Moreover, the relation between RC and AC is statistically significant ( $r(84) = .40, p < .01$ ). In order to evaluate in detail the relationship between RC and AC, partial correlation (controlling BK) was calculated. Controlling for BK, the partial correlation of RC and AC remains  $r = .32 (p < .01)$ . Hence, we rejected the “independent RC/AC –hypothesis” and assessed the “mediating RC-hypothesis”. As mentioned above, significant correlations exist between BK and RC and between RC and AC. A hierarchical linear regression showed that the original effect ( $\beta = .26, p < .05$ ) of the BK on AC decreased ( $\beta = .07$  n.s.), when RC was entered as a control variable. Sobel's test confirms that the decrease of the effect was significant ( $t = 2.71, p < .01$ ). Hence, we find evidence for a mediator model, with RC mediating the relation between BK and AC. Using RC and BK as a predictor, 17% of the variance of the AC-scores could be explained.

### DISCUSSION

The aim of this study was to develop competence measures for primary mathematics teachers' cognition based on the proposed model. The empirical results of the reliability analyses indicate that the three components of subject-specific teacher cognition could be operationalized in distinct measures. The scales were seen as



coherent enough, despite the inhomogeneous item types, item formats, and content areas. Consequently, the results of Lindmeier (2011) could be transferred to the context of primary teachers. Further, the measures are examined with the aid of the different groups, namely teachers certified and not-certified in mathematics. The instrument is able to indicate the expected differences and a mean difference for BK, RC, and the overall competence is observed. Surprisingly, no difference could be observed for the scale of AC. One explanation could be the nature of the video-presented classroom situations: We decided to use very prototypical situations that are expected to appear in every primary mathematics classroom, so that teachers who regularly teach mathematics could have learned to deal with these situations. But this consideration would lead to a limiting point of our study in respect to the predictive validity of our measures for instructional quality: If a teacher reacts appropriately in a very typical situation that is clearly focused in our vignette, it remains unclear whether the teacher would also “see” this situation during lesson (see above, professional vision). Consequently, future research has to show how far the measures are valid for predicting classroom performance and student achievement.

Our analyses of the relations between the measures showed that the relations between BK and AC and between AC and RC are of medium size, between BK and RC even large. Hence, the scales for RC und AC capture facets of teacher cognition that go “beyond” knowledge in the sense that the scales depend on professional knowledge but mirror further abilities to use knowledge in typical teaching tasks. Especially, for the AC that was measured by video-based items, these findings are in line with the studies that follow related ideas to measure the applicability of teacher knowledge.

The relationship between RC and AC is of medium size even when controlling for BK. Consequently, in this study, we do find a stable relation between RC and AC for primary teachers, what differs from our findings for secondary teachers. Further analysis shows that RC mediates the relationship between BK and AC, but this mediation explains only a small part of the variance in AC. This can be interpreted as follows: Although AC depends on BK and RC, AC clearly differs from BK and RC. We would explain this difference with the underlying different cognitive demands. Altogether, our findings underpin the important role of teacher knowledge. But at the same time we can elicit teaching-related competences that go beyond knowledge and thus would conclude that basic knowledge might be not sufficient to describe the variance of subject-specific teacher cognition.

## References

- Baumert, J., Kunter, M., Blum, W., Brunner, M., Voss, T., Jordan, A., ... Tsai, Y.-M. (2010). Teachers' mathematical knowledge, cognitive activation in the classroom and student progress. *AERJ*, 47(1), 133-180.
- Döhrmann, M., & Blömeke, S. (2012). The conceptualisation of mathematics competencies in the international teacher education study TEDS-M. *ZDM*, 44(3), 325-340.
- Enders, C. K. (2010). *Applied missing data analysis*. New York: Guilford Press.

- Hattie, J. (2009). *Visible learning: A synthesis of over 800 meta-analyses relating to achievement*. London: Routledge.
- Hill, H. C., Ball, D. L., Blunk, M., Goffney, I. M., & Rowan, B. (2007). Validating the ecological assumption: The relationship of measure scores to classroom teaching and student learning. *Measurement*, 5(2-3), 107-118.
- Hill, H. C., Schilling, S. G., & Ball, D. L. (2004). Developing measure of teachers' mathematics knowledge for teaching. *The Elementary School Journal*, 105(1), 11-30.
- Kersting, N. B., Givvin, K. B., Thompson, B. J., Santagata, R., & Stigler, J. W. (2012). Measuring usable knowledge. Teachers' analyses of mathematics classroom videos predict teaching quality and student learning. *AERJ*, 49(3), 568-589.
- Koeppen, K., Hartig, J., Klieme, E., & Leutner, D. (2008). Current issues in competence modeling and assessment. *Journal of Psychology*, 216(2), 61-73.
- Kunter, M., & Klusmann, U. (2010). Kompetenzmessung bei Lehrkräften: Methodische Herausforderungen. *Unterrichtswissenschaft*, 38(1), 68-86.
- Leinhardt, G., & Greeno, J. G. (1986). The cognitive skill of teaching. *Journal of Educational Psychology*, 77, 247-271.
- Lindmeier, A. (2011). *Modeling and measuring knowledge and competencies of teachers: A threefold domain-specific structure model for mathematics*. Münster: Waxmann.
- Lindmeier, A. (2013). Video-vignettenbasierte standardisierte Erhebung von Lehrer-kognitionen. In U. Riegel & K. Macha (Eds.), *Videobasierte Kompetenzforschung in den Fachdidaktiken* (pp. 45-62). Münster: Waxmann.
- Richter, D., Kuhl, P., & Reimers, H. (2012). Aspekte der Aus- und Fortbildung von Lehrkräften in der Primarstufe. In P. Stanat, H. A. Pant, K. Böhme, & D. Richter (Eds.), *Kompetenzen von Schülerinnen und Schülern am Ende der vierten Jahrgangstufe in den Fächern Deutsch und Mathematik* (pp. 237-251). Münster: Waxmann.
- Schön, D. A. (1990). *Educating the reflective practitioner*. San Francisco: Jossey-Bass.
- Senk, S. L., Tatto, M. T., Reckase, M., Rowley, G., Peck, R., & Bankov, K. (2014). Knowledge of future primary teachers for teaching mathematics: An international comparative study. In S. Blömeke, F.-J. Hsieh, G. Kaiser, & W. H. Schmidt (Eds.), *International perspectives on teacher knowledge, beliefs and opportunities to learn. TEDS-M results* (pp. 61-90). Dordrecht: Springer.
- Stürmer, K., Könings, K., & Seidel, T. (2013). Declarative knowledge and professional vision in teacher education: Effect of courses in teaching and learning. *British Journal of Educational Psychology*, 83(3), 467-483.
- Tiedemann, J., & Billmann-Mahecha, E. (2007). Macht das Fachstudium einen Unterschied? Zur Rolle der Lehrerexpertise für Lernerfolg und Motivation in der Grundschule. *Zeitschrift für Pädagogik*, 53, 58-73.
- Vondrová, N., & Žalská, J. (2013). Mathematics for teaching and pre-service mathematics teachers' ability to notice. In A. M. Lindmeier, & A. Heinze (Eds.). *Proceedings of the 37<sup>th</sup> PME* (Vol. 4, pp. 361-368). Kiel (Germany): PME.





**INDEX OF AUTHORS  
AND COAUTHORS  
Volume 3**

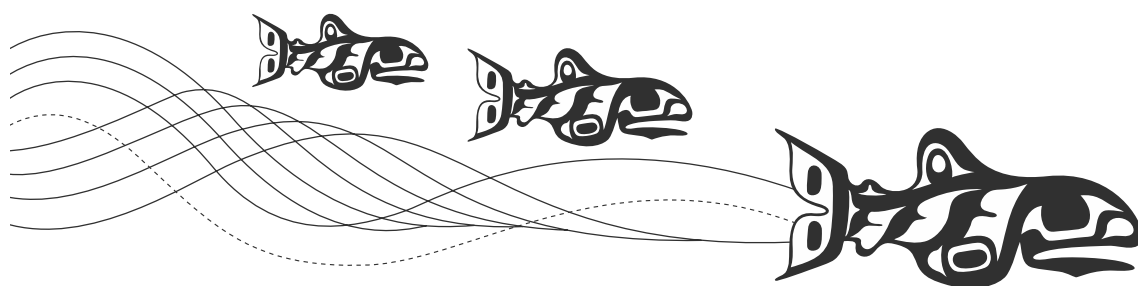



**A**

Abdul Rahman, Shafia .....	137
Aguilar, Mario Sánchez.....	89
Amit, Miriam.....	161
Anthony, Glenda.....	364

**B**

Bayliss, Donna.....	340
Beswick, Kim .....	153
Biehler, Rolf.....	429
Bobadilla, Roberto.....	185
Bofah, Emmanuel.....	250

**C**

Cai, Jinfa.....	396
Carrillo, José.....	81
Choi, Kyong Mi.....	332
Civil, Marta.....	41
Conner, AnnaMarie .....	177
Connor, Jeff.....	233

**D**

Dartnell, Pablo.....	185
Dawson, Clare .....	33
Didis, M. Gözde .....	380
Dimmel, Justin.....	274
Dreyfus, Tommy.....	217, 283

**E**

Eichler, Andreas .....	25
Ellis, Amy B. ....	1
Ellis, Jessica.....	9
Erath, Kirstin .....	17
Erens, Ralf.....	25
Erickson, Ander.....	274
Escudero, Dinazar I. ....	89
Evans, Sheila .....	33

**F**

Fede, Bryan .....	41
Fernandes, Solange Hassan Ahmad Ali .....	49
Ferrara, Francesca .....	57, 65
Ferrer, Miquel .....	73
Flores, Eric .....	81, 89
Forgasz, Helen.....	193
Fortuny, Josep M.....	73
Foster, Colin.....	97
Frade, Cristina.....	105
Freiman, Viktor.....	113
Fritzlar, Torsten.....	121
Fukawa-Connelly, Tim .....	129

**G**

Gates, Peter .....	137
Gerofsky, Susan .....	145
Getenet, Seyum Tekeher .....	153
Gilat, Talya.....	161
Goizueta, Manuel .....	169
Goldman, Susan .....	420
Gomez, Carlos Nicolas .....	177
Gómez, David M.....	185
Gómez-Chacón, Inés M <sup>a</sup> .....	193
González-Martín, Alejandro S. ....	201
Greenlees, Jane.....	209

**H**

Haj Yahya, Aehsan .....	217
Hall, Jennifer.....	225
Hallman-Thrasher, Allyson.....	233
Hannah, John.....	242
Hannula, Markku S. ....	250
Hayata, Toru.....	258
Healy, Lulu.....	49
Heemsoth, Tim.....	266
Heffernan, Cristina.....	420
Heffernan, Neil.....	420
Heinze, Aiso.....	266, 437

Herbst, Patricio .....	274
Hershkowitz, Rina .....	217, 283
Hewitt, Dave .....	292
Hiebert, Erica J. A. ....	300
Hino, Keiko .....	308
Ho, Siew Yin .....	316
Hodkowski, Nicola .....	324
Hong, Dae S. ....	332
Hopkins, Sarah .....	340
Hsieh, Feng-Jui .....	348
Huang, Hsin-Mei E. ....	356
Hunter, Roberta .....	364

---

**I**

Indiogene, Salvatore Enrico .....	372
-----------------------------------	-----

---

**J**

Jaworski, Barbara .....	380
Jayakody, Gaya N. ....	388
Jiang, Chunlian .....	396
Jiménez, Abelino .....	185
Johnson, Heather Lynn .....	324
Jones, Ian .....	33
Jones, Steven R. ....	404

---

**K**

Kaur, Harpreet .....	412
Kelly, Kim .....	420
Kempen, Leander .....	429
Knieval, Imke .....	437
Ko, Inah .....	274
Koizumi, Yuka .....	308
Kosko, Karl W. ....	274
Koyama, Masataka .....	258
Kulm, Gerald .....	372

---

**L**

Leder, Gilah .....	193
Lerman, Stephen .....	105
Lew, Kristen .....	129
Lindmeier, Anke .....	437
Lockwood, Elise .....	1

Logan, Tracy .....	209
Lowrie, Tom .....	316

---

**M**

Mammana, Maria Flavia .....	57
Mariotti, Maria Alessandra .....	169
McClintock, Evan .....	324
Meira, Luciano .....	105
Mejia-Ramos, Pablo .....	129
Metsämuuronen, Jari .....	250
Morera, Laura .....	73

---

**N**

Ng, Oi-Lam .....	65
------------------	----

---

**P**

Pellegrino, James .....	420
Planas, Núria .....	73, 169
Prediger, Susanne .....	17

---

**R**

Ramful, Ajay .....	316
Rasmussen, Chris .....	283
Reyes, Cristián .....	185
Rink, Roland .....	121

---

**S**

Sinclair, Nathalie .....	412
Soffer-Goldstein, Deena .....	420
Stewart, Sepideh .....	242
Swan, Malcolm .....	97

---

**T**

Tabach, Michal .....	283
Thomas, Mike .....	242
Toscano, Rocío .....	41
Tuohilampi, Laura .....	250
Tzur, Ron .....	324

---

**V**

Volkov, Alexei .....	113
----------------------	-----



**W**

---

Wake, Geoff .....97

Wang, Ting-Ying ..... 348

Weber, Eric ..... 1

Weber, Keith ..... 129